

EMPFÄNGER- SCHALTUNGEN

DER
RADIO-INDUSTRIE



Dyn 1
p. 302

~~Dot. G. F-13- VIII - 61-B~~

POLITECHNIKA ŚLĄSKA
Katedra Elektroniki Przemysłowej

S/83

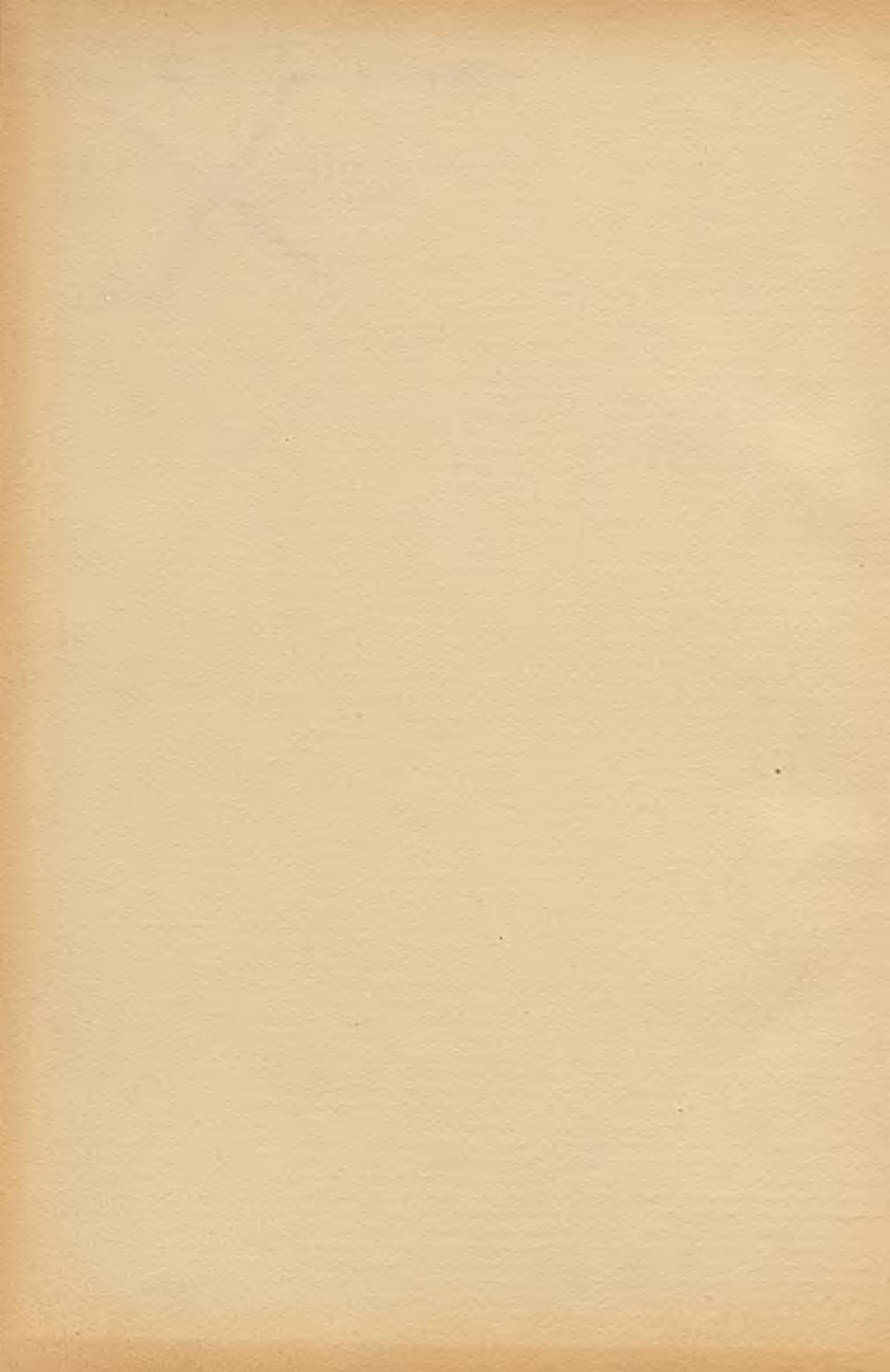

EMPFÄNGER-SCHALTUNGEN DER RADIO-INDUSTRIE

BAND II

~~POLITECHNIKA ŚLĄSKA
Katedra Elektroniki Przemysłowej~~

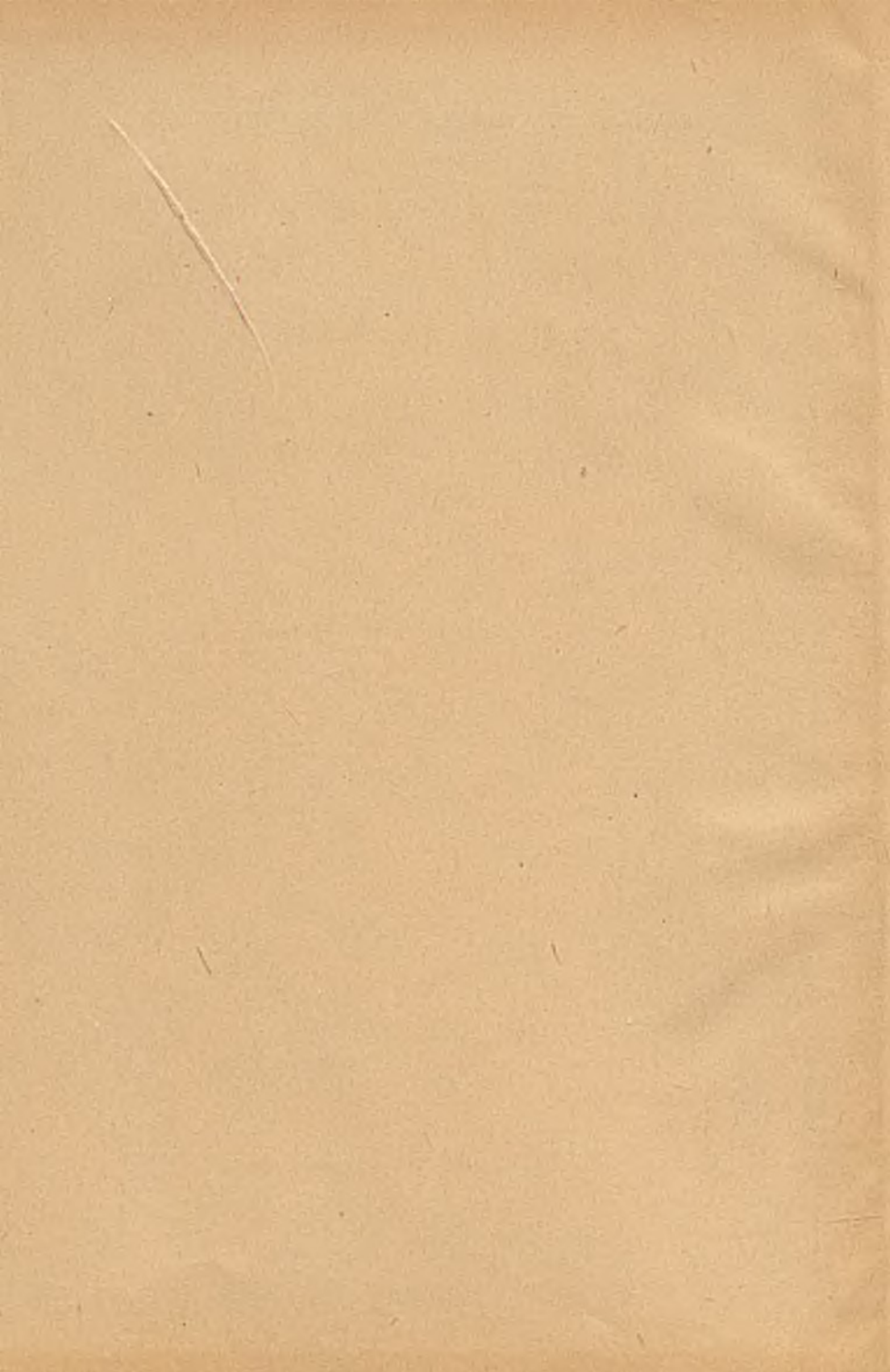

BÜCHER FÜR DEN RUNDFUNKTECHNIKER

POLITECHNIKA ŚLĄSKA
Katedra Elektrotechniki i Telekomunikacji

**EMPFÄNGER-
SCHALTUNGEN**
DER
RADIO-INDUSTRIE

BAND II

Zusammengestellt von Ing. Heinz Lange
und Ing. Heinz K. Nowisch

Dritte Auflage



FACHBUCHVERLAG GMBH LEIPZIG 1953



126433

Redaktionsschluss 26. Juni 1952

Alle Rechte vorbehalten Fachbuchverlag GmbH Leipzig

Copyright 1950 by Deutscher Funk-Verlag

Satz und Druck: Druckhaus „Maxim Gorki“, Altenburg

Veröffentlicht unter der Lizenznummer 114-210/130/52 des Amtes für Literatur
und Verlagswesen der Deutschen Demokratischen Republik

D 1384109

Dieses Buch setzt als II. Band die Schaltbildersammlung fort, in der 30 Jahre rastloser Arbeit deutscher Fachleute ihren Niederschlag finden. Es ist gelungen, ein Standardwerk zusammenzustellen, das für die gesamte Radiotechnik von unschätzbarem Werte ist.

Angefangen vom Audionempfänger aus dem Jahre 1924 bis zu den höchstentwickelten Spitzengeräten, deren Produktion durch den zweiten Weltkrieg unterbrochen wurde, und wieder beginnend mit den ersten primitiven Nachkriegsgeräten bis zu den letzten Konstruktionen sind die Schaltungen, nach Firmen und Typen geordnet, in dem Gesamtwerke zu finden.

Mit dieser Schaltungssammlung wollen wir dazu beitragen, die Instandsetzung von Rundfunkgeräten wesentlich zu erleichtern und damit einem dringenden Bedürfnis der Reparaturwerkstätten entsprechen — das alles mit dem Ziele, für recht viele schaffende Menschen den Empfang unserer Rundfunksendungen zu vervollkommen.

Darüber hinaus gibt diese Sammlung unserem Nachwuchs in der Werkstatt, den Studierenden der Elektrotechnik und den Entwicklungsingenieuren einen umfassenden Überblick über die Vielfalt und den Ideenreichtum der Schaltungstechnik.

Eine Bitte richten wir an alle, in deren Hände diese Sammlung gelangt:

Sollten Sie noch im Besitz von Schaltungsunterlagen sein, die in dieser Sammlung nicht enthalten sind, so überlassen Sie uns diese für eine kurze Zeit. Damit würden Sie zum Nutzen der gesamten Radiotechnik zur Vervollständigung der Sammlung beitragen.

Allen Industriebetrieben, durch deren Mitarbeit dieses Werk entstehen konnte, sprechen wir hiermit unseren Dank aus.

Verfasser und Verlag

Leipzig, im Sommer 1953

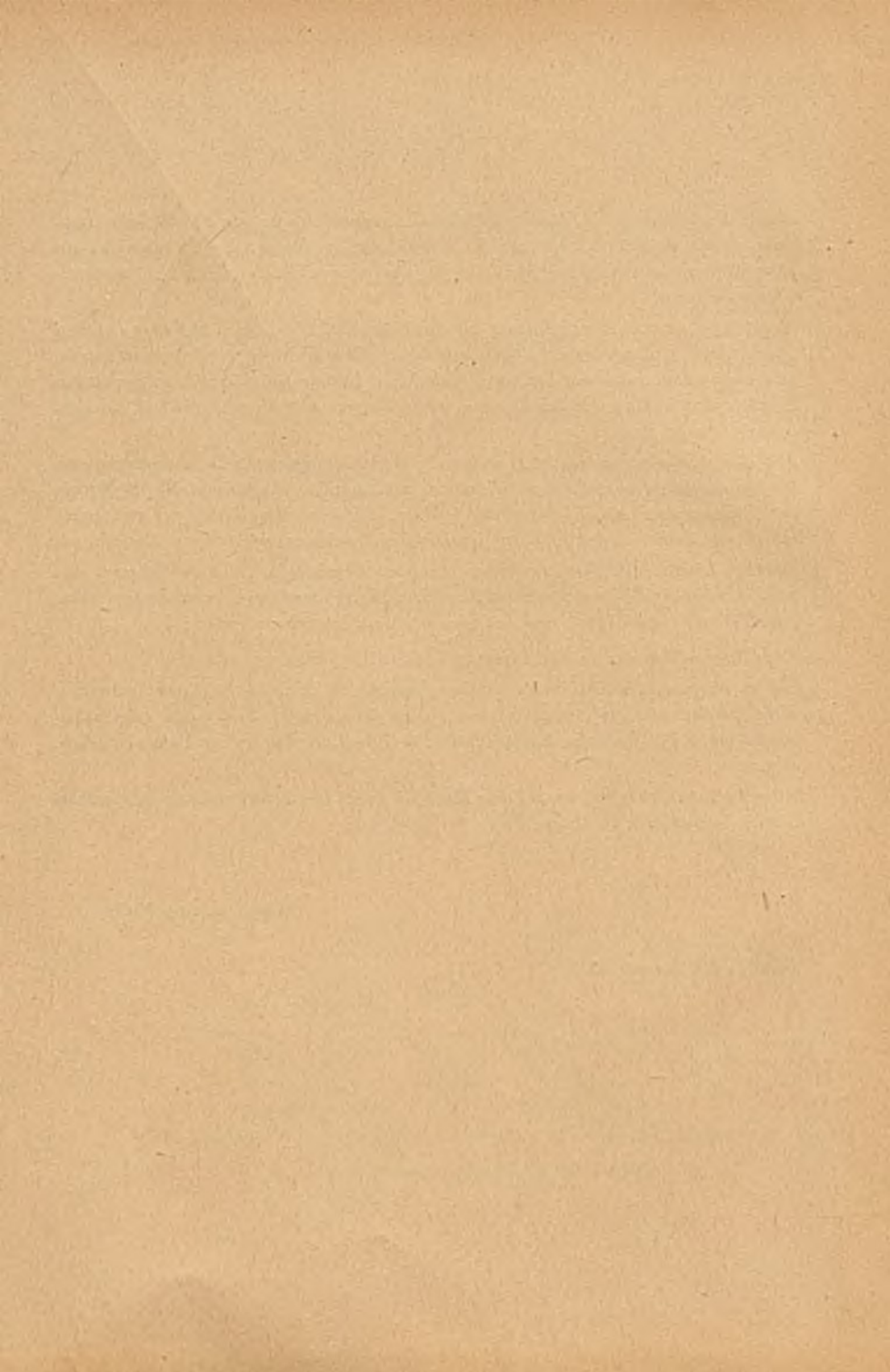

Vorwort	5	W 165 und LW 195	50
<i>Blohm</i>		159 Columbus	51
AHS 23	13	133 W/143 W Columbus	52
UHS 23	14	124 B 2 und 149 B 2	53
CHS 23	15	120 B	54
Musiktruhe MT 15 E	16	119 B 2 Columbus	55
Musiktruhe MT 20		112 G Columbus	56
„Symphonetta“	18	109 B Columbus	57
Standard-Super HS 6823	19	108 B 4	58
		107 W Columbus	59
		106 B	60
<i>Brandt (Produktion nach 1945)</i>		104 B Columbus	61
Favorit 3449 GW	23	S 103 GW	62
Favorit 3449 GW/ML	24	S 101 ML	63
Favorit 3449 GW II/KM	25	S 101 MK	64
649 GW	26	LG 100 Columbus	65
550 B „Melodie“	27	G 100 Columbus	66
450 GW	28	97 B 4	67
449 GW	29	97 B 2	68
448 GW	30	94 W Columbus	69
150 GW „Kobold“	31	80 B Columbus	70
148 GW/KK	32	76 Columbus	71
146 GW/KM	33	W 64 und LW 80	72
		56 W und 72 LW	73
		55 W Columbus	74
<i>Brandt (Produktion vor 1945)</i>		55 G Columbus	75
S 301 WK	37	40 WK Jubilar	76
217 W Columbus	38	40 GWK Jubilar	77
205 B/4 V	39	40 BK Jubilar	78
S 201 WK	40	38 W Jubilar	79
S 201 GWK	41	38 GW Jubilar	80
198 B 2	42	38 B Jubilar und 192 B 2	81
188 B Columbus	43		
188 B 2 Columbus	44	<i>Braun (Produktion nach 1945)</i>	
188 B 22	45	4650 W	85
181 WK und 196 W	46	4648 W	86
LW 180 und W 153	47	4648 GW	87
170-2/2 Columbus	48	4549 GW	88
169 GW Columbus	49	4547 W	89

4547 GW	90
660 W siehe 650 W	
650 W	91
460 GW	92
450 GW	93
449 D und BSK 441	94
Piccolo 50	95

Braun (Produktion vor 1945)

Mozart W	99
Kobold 3 Röhren	100
Kobold W	101
Kobold G	102
Cosmophon 333/444/777	103
6741 W	104
6740 W	105
6740 GW	106
5641 W	107
5641 GW	108
5640 W	109
4742 W	110
4742 GW	111
4642 GW/1	112
4642 GW/2	113
4642 GW/3 und H 46 GW	114
4640 W	115
4640 GW	116
739 W	117
739 GW	118
737 W	119
737 GW	120
715 GW	121
710 W	122
639 W	123
639 GW	124
637 W	125
637 GW	126
Trumpf-Junior 555 GL	127
Trumpf-Junior 565 GL	127
Trumpf-Junior 575 GL	127
Trumpf-Junior 585 GL	127
Trumpf-Junior 550 W	128

Trumpf-Junior 560 W	128
Trumpf-Junior 570 W	128
Trumpf-Junior 580 W	128
537 W	129
537 GW	130
Trumpf 525 GL	131
Trumpf 545 GL	131
Trumpf 520 W	132
Trumpf 540 W	132
Trumpf 515 GL	133
Trumpf 535 GL	133
Trumpf 510 W	134
Trumpf 530 W	134
239 W und 638 W	135
239 GW und 638 GW	136
BSK 239 F	137
BSK 239 D	138
BSK 238 F	139
BSK 238 D	140
BSK 237 K	141
BSK 237	142
137 W	143
137 GW	144
F 56 GW	145
BS 41	146
BS 40	147
BS 39	148
BS 37	149
BNA 37	150
BSK 36	151
4 W 7	152
4 GW 7	153
4 W 6	154
4 GW 6	155
4 W	156
4 G	157
3 W 5	158
3 W	159
ER 3	160

Continental

Imperial 660 W	163
Imperial 61 W (bis Gerät Nr. 3341)	164

Imperial 61 W m. 2 Lautsprechern (ab Gerät Nr. 3342)	165	W 313 (E)	207
Imperial 62 W	166	W 364	208
Imperial 50 GW	167	<i>Elcophon</i>	
21 GW (Gerät Nr. 3332 — 3573)	168	A/By 49	211
<i>DTW (Produktion nach 1945)</i>		<i>Elektro-Apparate-Fabrik,</i>	
513	171	<i>Köppelsdorf</i>	
<i>DTW (Produktion vor 1945)</i>		65/50 WKS II	215
1026 W Norderney	175	912/50 W	216
975 W	176	88/48 W	218
964 W	177	65/49 WKS	220
964 GW	178	65/48 W	221
913 W	179	64/50 GWS	222
876 W	180	64/49 WKS	223
865 W	181	64/48 W	224
864 GW	182	5/47 W II	225
824 W	183	3/48 GW	226
824 GW	184	3/47 W	227
754 W	185	<i>Elektro-Apparate-Werke, Treptow</i>	
754 GW	186	AT 560 GWK 3	231
723 W	187	AT 466 GWK	232
712 W und 812 W	188	AT 467 GWK	233
462 GW	189	AT 467 GWKu	234
235 W Stolzenfels	190	AT 218 WKe	235
235 GW Stolzenfels	191	AT 217 GWK	236
127 W und 128 W	192	<i>Elmug</i>	
126 W Rügen	193	Alfa WL 4513 W	239
126 GW Helgoland	194	<i>Eltra</i>	
125 W Helgoland	195	349 GWK	243
124 W „B“ Europa	196	347 GW	244
34	197	249 GWK	245
W 1 Neutrohet	198	247 GWK	246
<i>Elbeg</i>		246 GWK	247
GL 8147 W	201	149 GWK-U	248
<i>Elbia</i>		149 GWK	249
W 212	205	149 GW	250
W 313 (A)	206	145 GW	251

Emud (Produktion nach 1945)

Superette W	255
Superette GW	256
Super 50 W	257
Super 50 GW	258
Record 89 WKN	259
Record 89 GWK	260
Favorit 2 GWL 115	261

Emud (Produktion vor 1945)

Ulm W	265
Ulm G	266
Saarbrücken W	267
Berlin W	268
Berlin G	269
139 WK Record	270
89 WKE	271

89 WK Record	272
E 47 W	273
42 W Record	274
42 GW Record	275
33 W	276
31 W Record	277
23 W	278
22 W	279
22 GW	280
B 4	281
L 2 W und 200 W	282
L 2 G und 200 G	283

Funkstrahl

Nachtigall WK 47	287
Nachtigall GWK 47	288
Zaunkönig W 45	289
Zaunkönig G 45	290

BLOHM



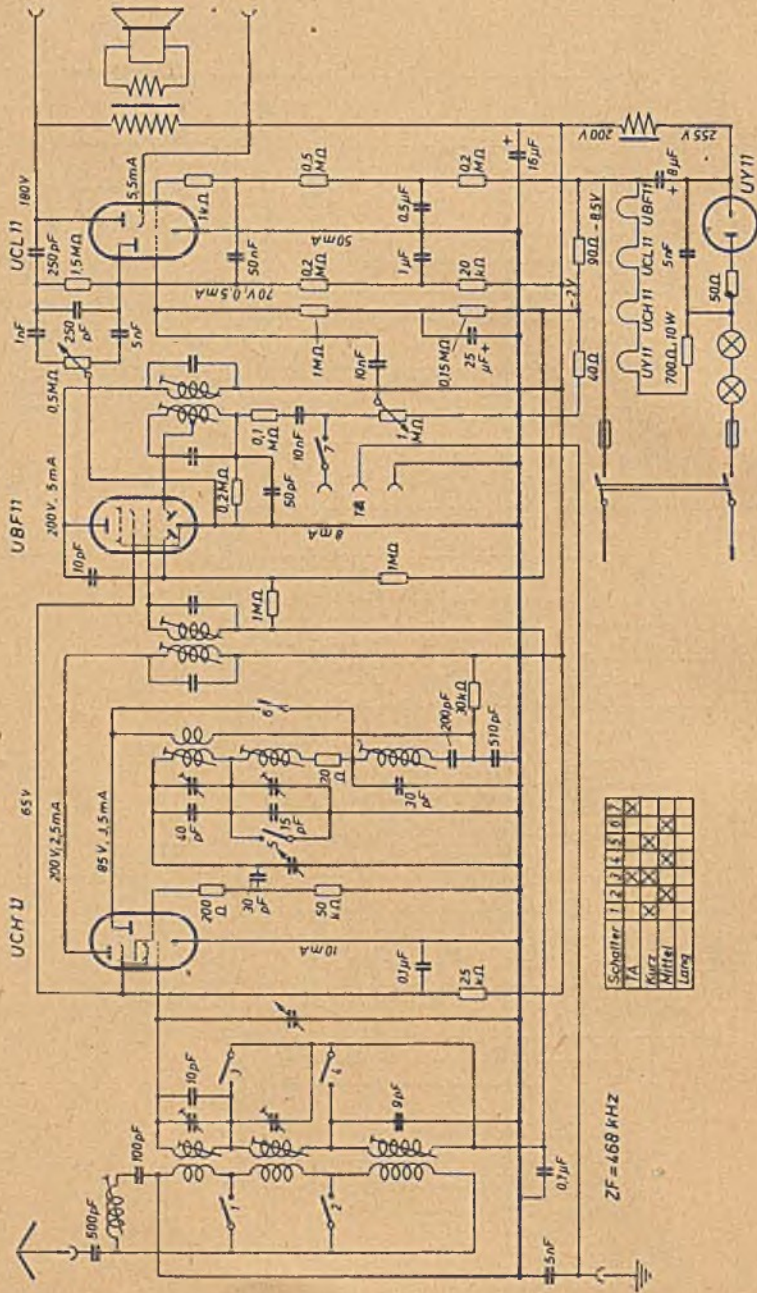

Schalter	1	2	3	4	5	6	7	8	9	10	11	12
TA												
Kurz												
Mittel												
Läng												

ZF = 468 kHz

POLITECHNIKA ŚLĄSKA
Katedra Elektroniki Przemysłowej

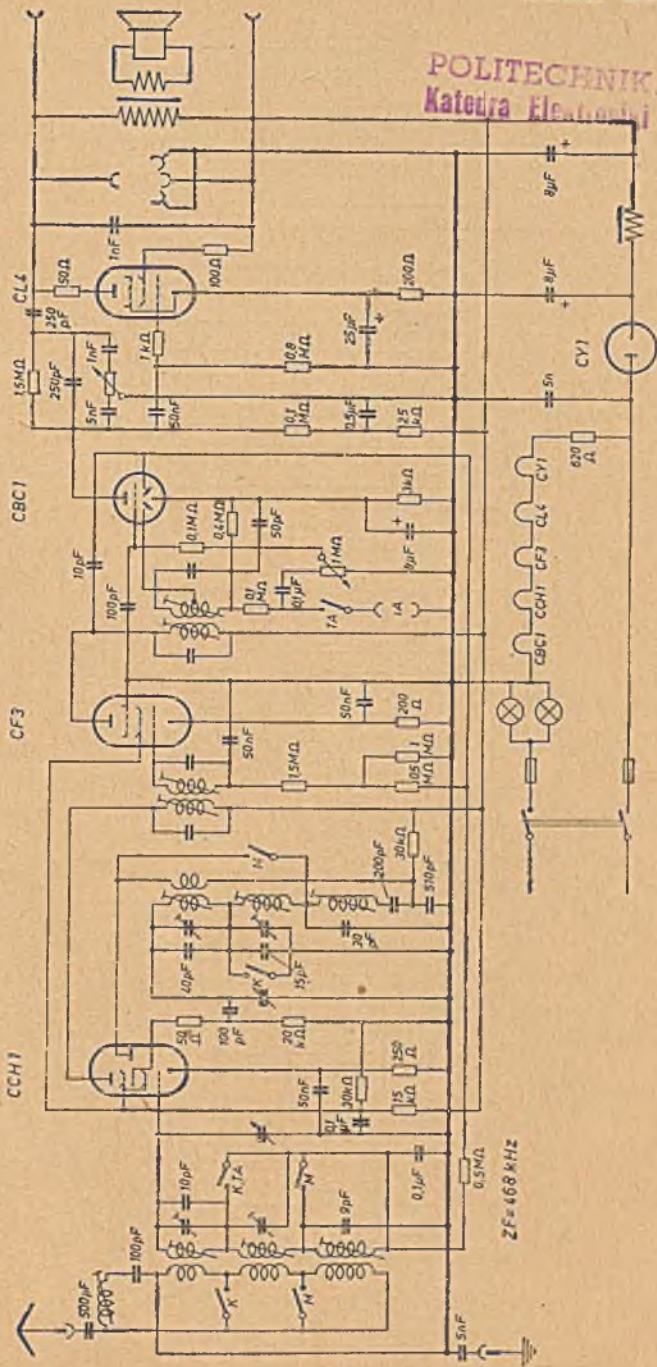

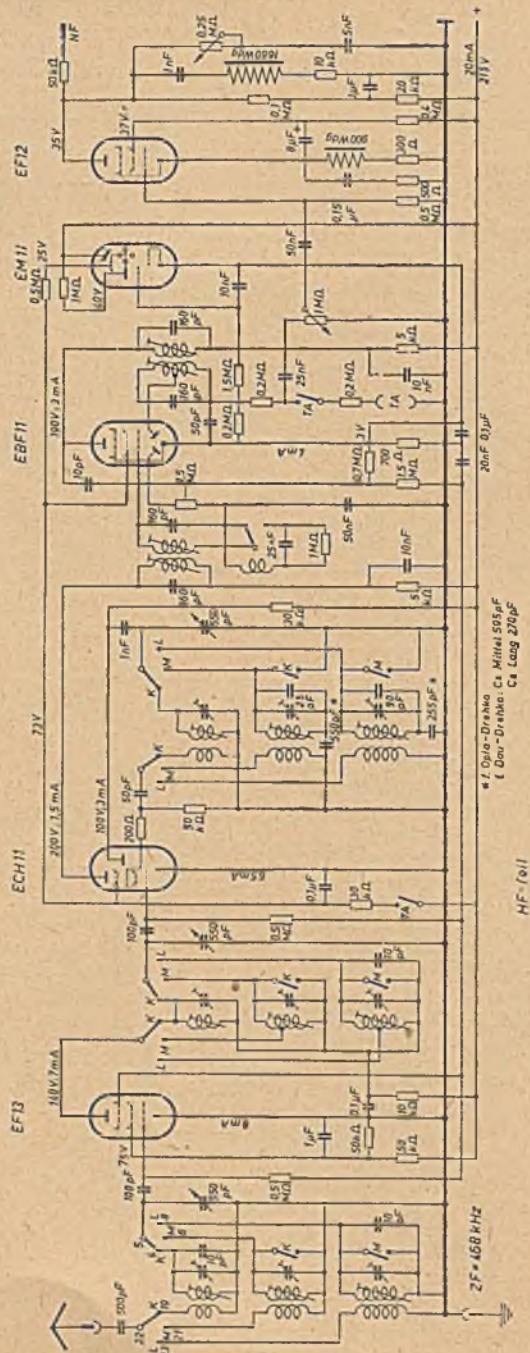

Blohm Musiktruhe MT 15 E

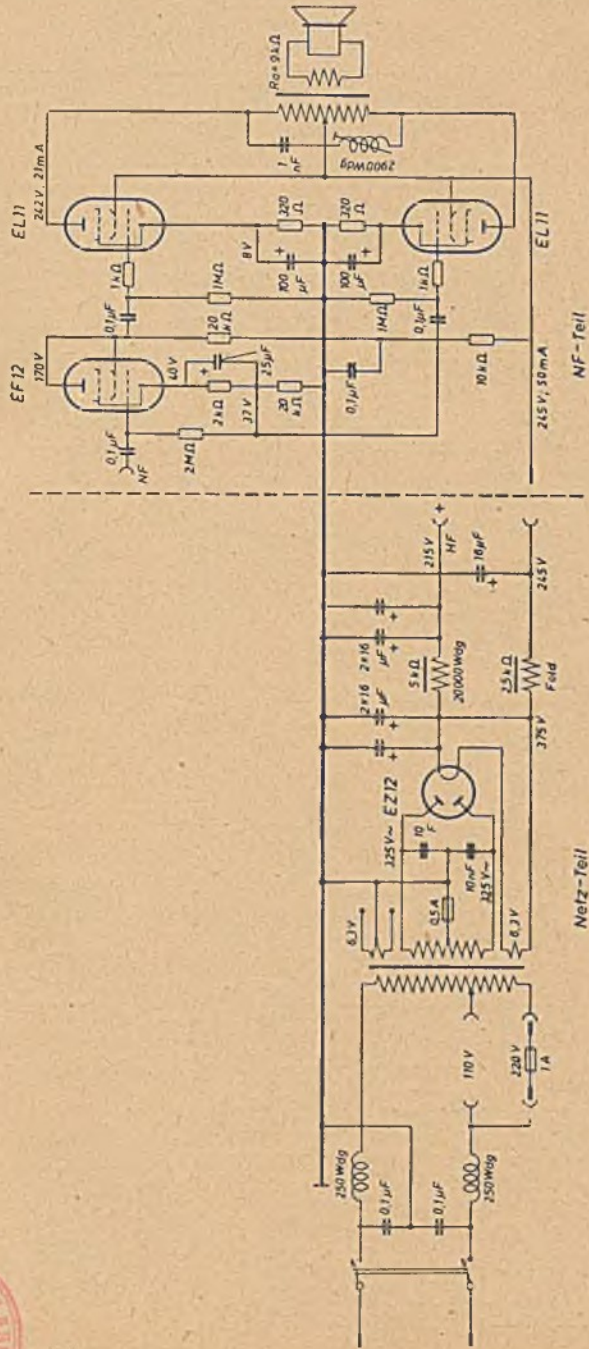

Blohm Musiktruhe MT 20 „Symphonetta“

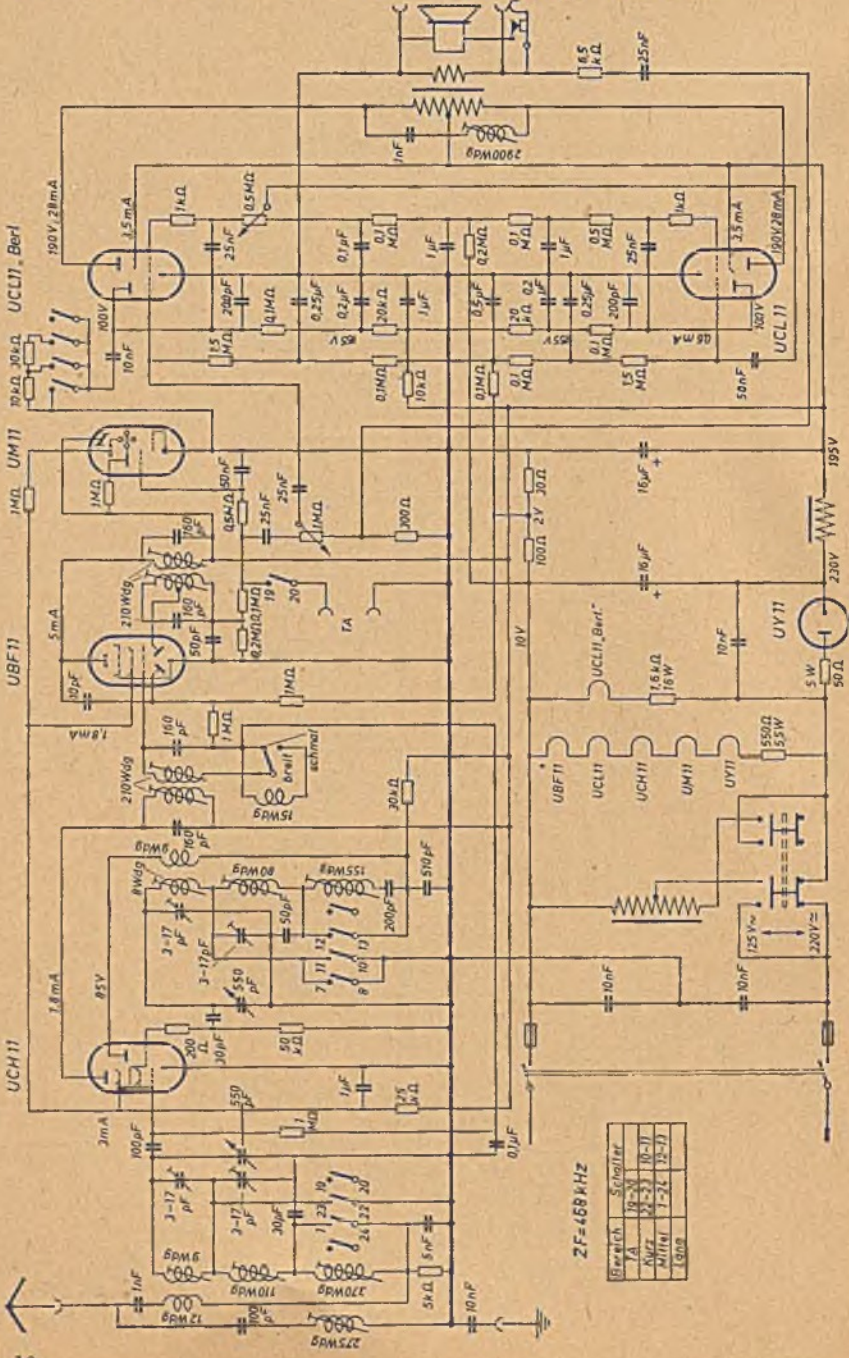

ZF = 468 kHz

Bezeichnung	Schalter
TA	18-20
NuZ	21-23 10-11
Mittel	1-2 12-13
1000	

Blohm Standard-Super HS 6823

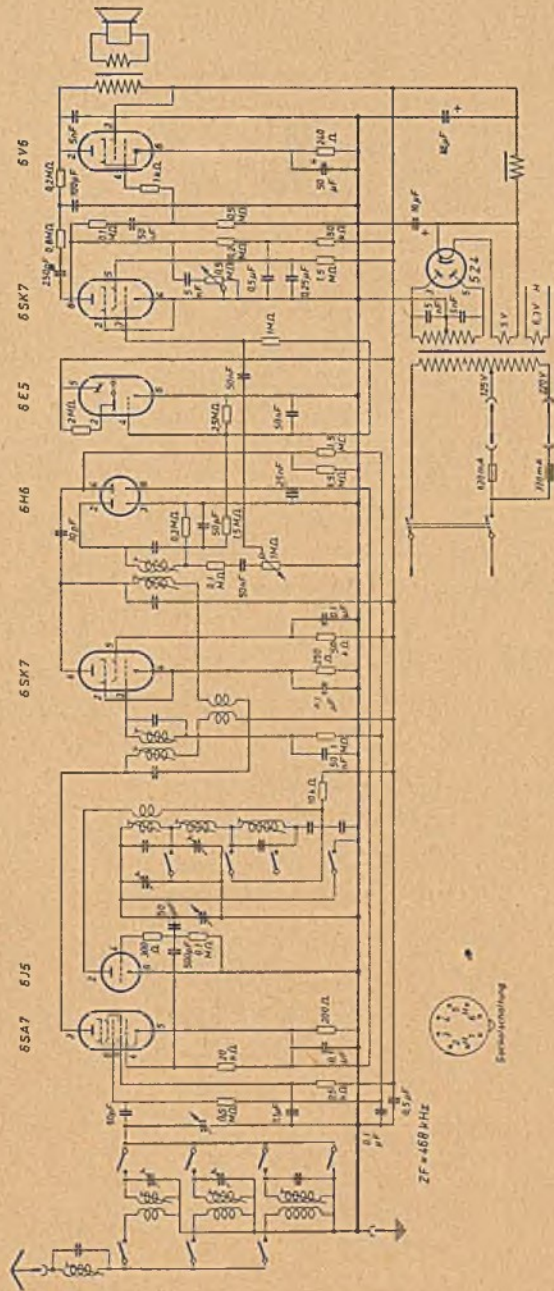



BRANDT

(Produktion nach 1945)



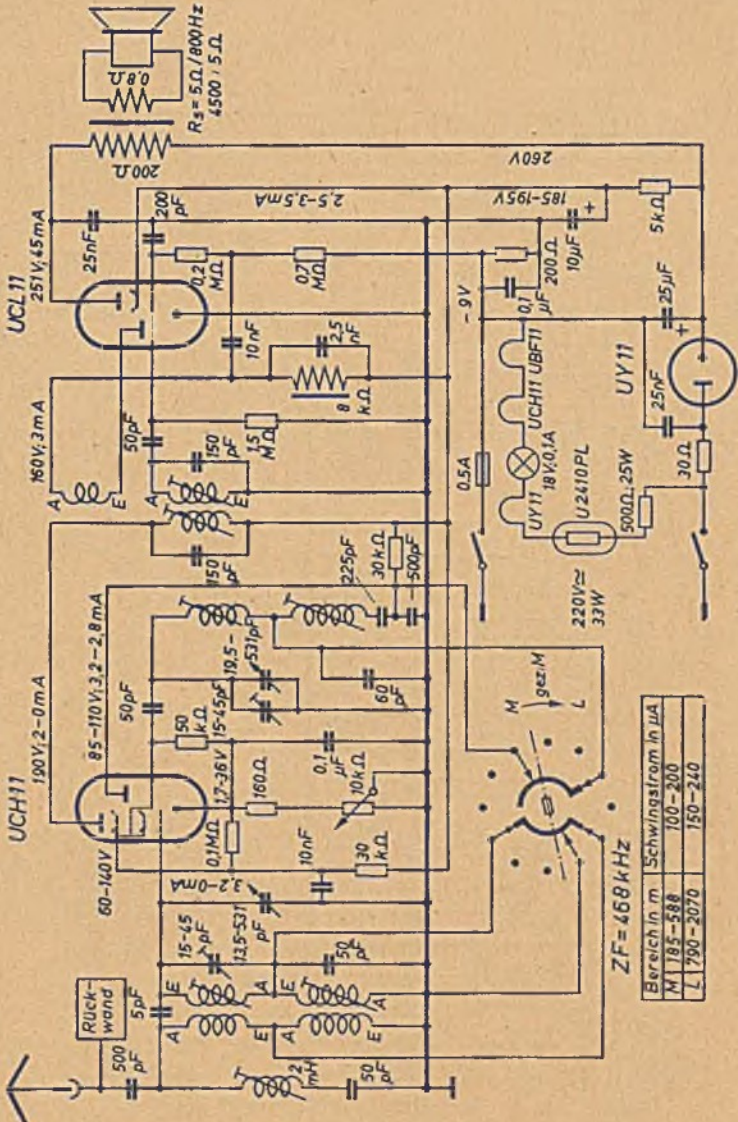

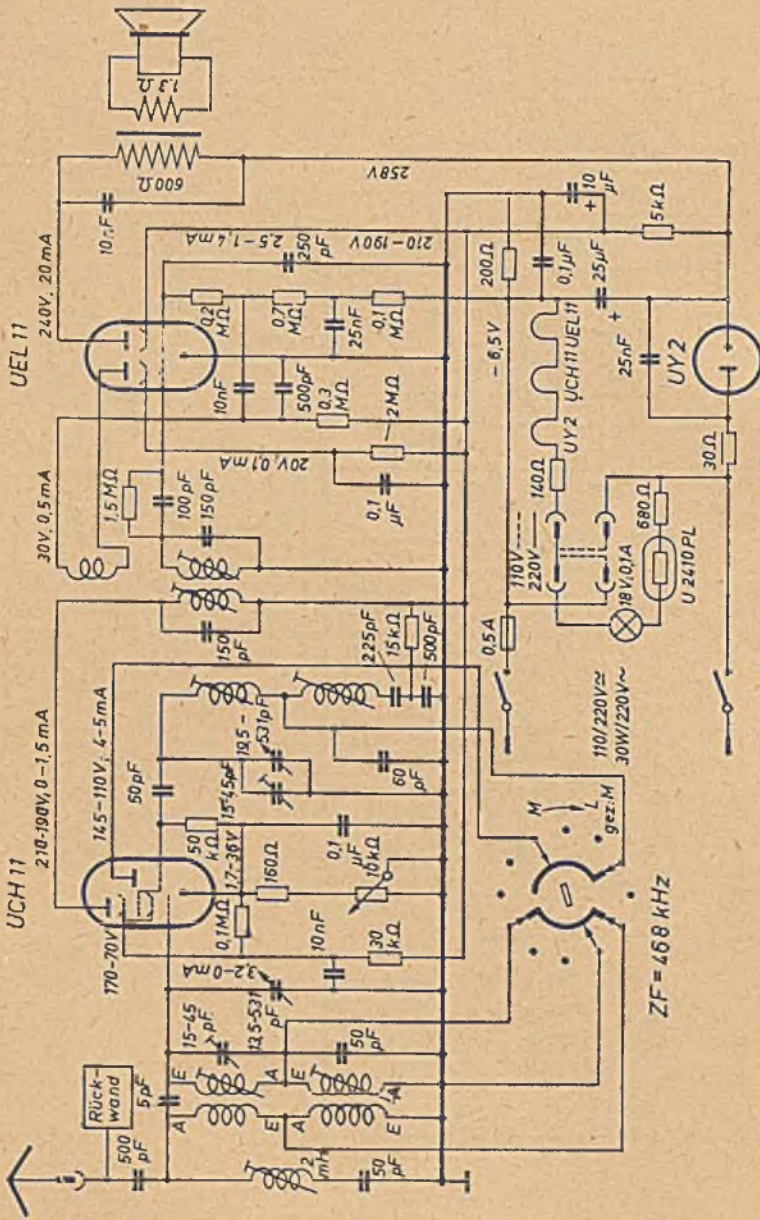

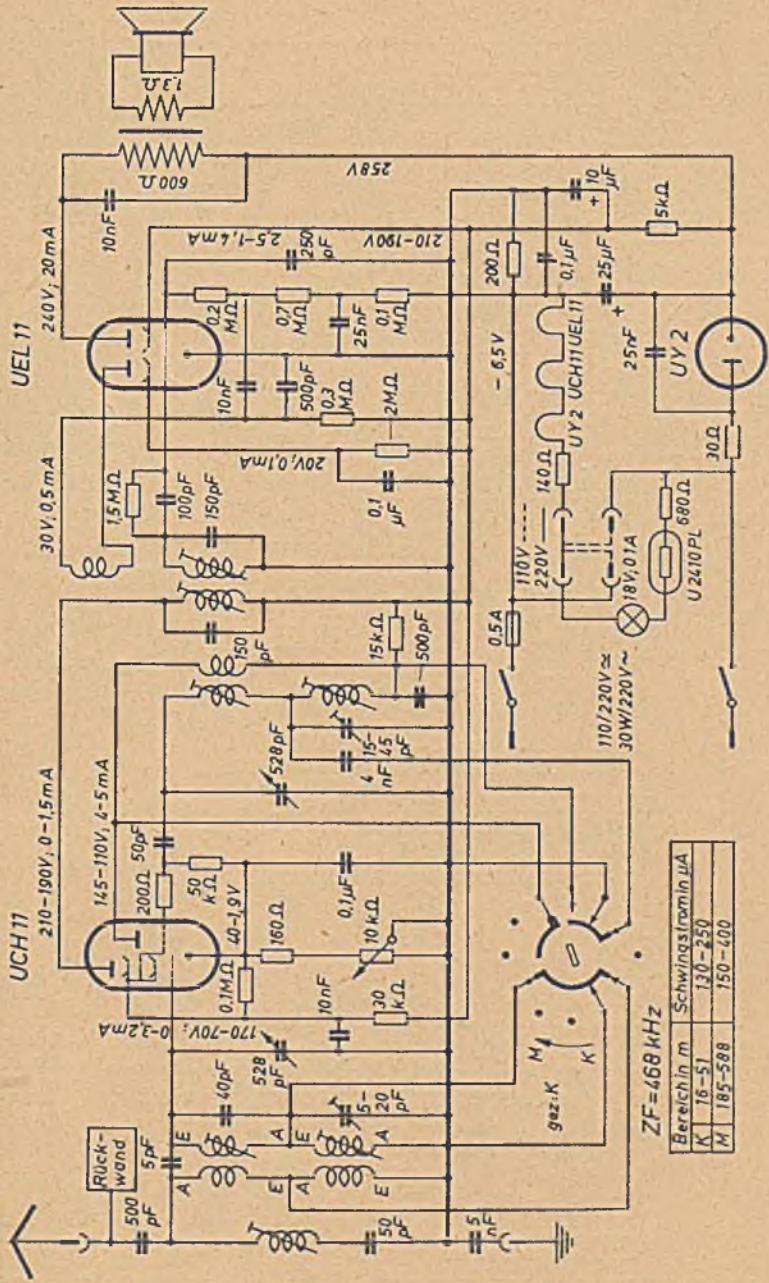

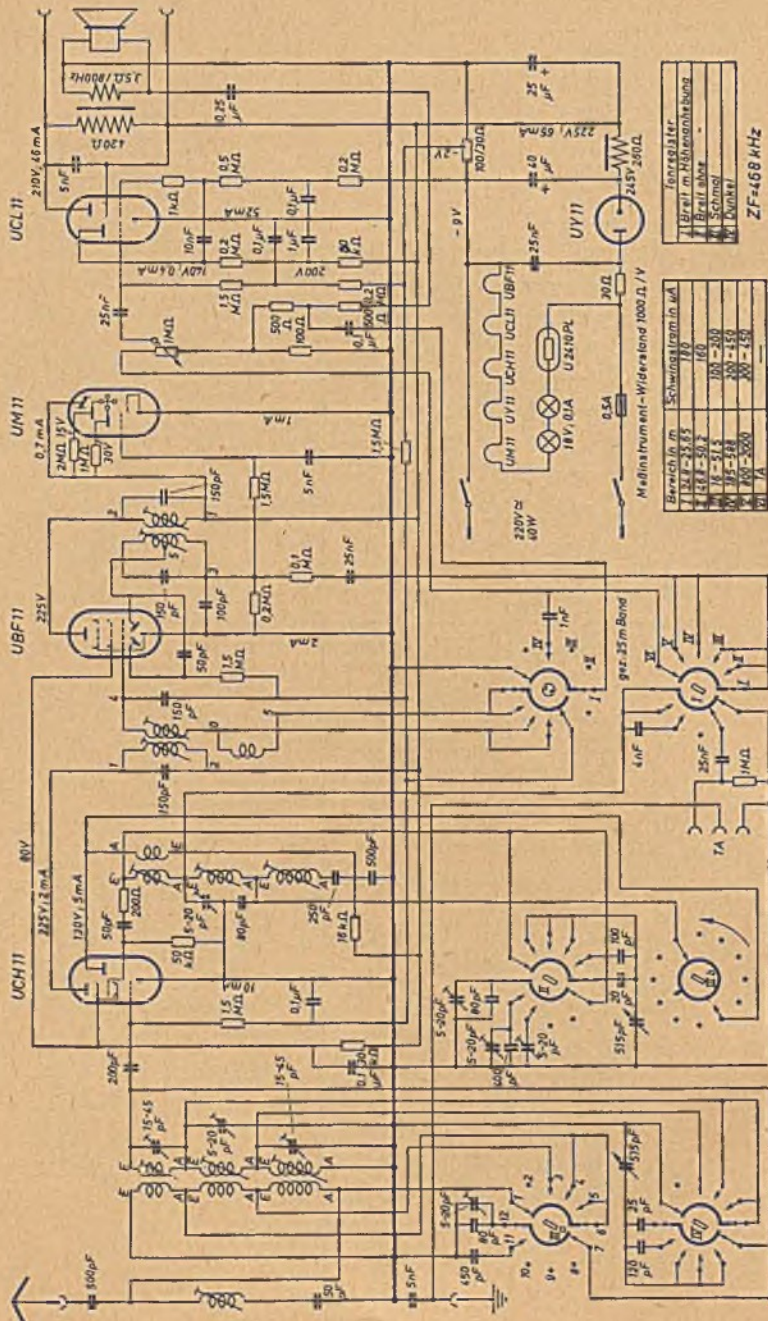

Leistungsfaktor

1. Bereich in m	Schwingstrom in mA
1. Bereich	100 - 200
2. Bereich	200 - 400
3. Bereich	400 - 600
4. Bereich	600 - 800
5. Bereich	800 - 1000
6. Bereich	1000 - 1200
7. Bereich	1200 - 1400
8. Bereich	1400 - 1600
9. Bereich	1600 - 1800
10. Bereich	1800 - 2000
11. Bereich	2000 - 2200
12. Bereich	2200 - 2400
13. Bereich	2400 - 2600
14. Bereich	2600 - 2800
15. Bereich	2800 - 3000
16. Bereich	3000 - 3200
17. Bereich	3200 - 3400
18. Bereich	3400 - 3600
19. Bereich	3600 - 3800
20. Bereich	3800 - 4000
21. Bereich	4000 - 4200
22. Bereich	4200 - 4400
23. Bereich	4400 - 4600
24. Bereich	4600 - 4800
25. Bereich	4800 - 5000
26. Bereich	5000 - 5200
27. Bereich	5200 - 5400
28. Bereich	5400 - 5600
29. Bereich	5600 - 5800
30. Bereich	5800 - 6000
31. Bereich	6000 - 6200
32. Bereich	6200 - 6400
33. Bereich	6400 - 6600
34. Bereich	6600 - 6800
35. Bereich	6800 - 7000
36. Bereich	7000 - 7200
37. Bereich	7200 - 7400
38. Bereich	7400 - 7600
39. Bereich	7600 - 7800
40. Bereich	7800 - 8000
41. Bereich	8000 - 8200
42. Bereich	8200 - 8400
43. Bereich	8400 - 8600
44. Bereich	8600 - 8800
45. Bereich	8800 - 9000
46. Bereich	9000 - 9200
47. Bereich	9200 - 9400
48. Bereich	9400 - 9600
49. Bereich	9600 - 9800
50. Bereich	9800 - 10000

Medialinstrument-Widerstand 1000 Ω / V

1. Bereich	1000 - 1200
2. Bereich	1200 - 1400
3. Bereich	1400 - 1600
4. Bereich	1600 - 1800
5. Bereich	1800 - 2000
6. Bereich	2000 - 2200
7. Bereich	2200 - 2400
8. Bereich	2400 - 2600
9. Bereich	2600 - 2800
10. Bereich	2800 - 3000
11. Bereich	3000 - 3200
12. Bereich	3200 - 3400
13. Bereich	3400 - 3600
14. Bereich	3600 - 3800
15. Bereich	3800 - 4000
16. Bereich	4000 - 4200
17. Bereich	4200 - 4400
18. Bereich	4400 - 4600
19. Bereich	4600 - 4800
20. Bereich	4800 - 5000
21. Bereich	5000 - 5200
22. Bereich	5200 - 5400
23. Bereich	5400 - 5600
24. Bereich	5600 - 5800
25. Bereich	5800 - 6000
26. Bereich	6000 - 6200
27. Bereich	6200 - 6400
28. Bereich	6400 - 6600
29. Bereich	6600 - 6800
30. Bereich	6800 - 7000
31. Bereich	7000 - 7200
32. Bereich	7200 - 7400
33. Bereich	7400 - 7600
34. Bereich	7600 - 7800
35. Bereich	7800 - 8000
36. Bereich	8000 - 8200
37. Bereich	8200 - 8400
38. Bereich	8400 - 8600
39. Bereich	8600 - 8800
40. Bereich	8800 - 9000
41. Bereich	9000 - 9200
42. Bereich	9200 - 9400
43. Bereich	9400 - 9600
44. Bereich	9600 - 9800
45. Bereich	9800 - 10000

ZF=468 kHz

Brandt 550 B „Melodie“

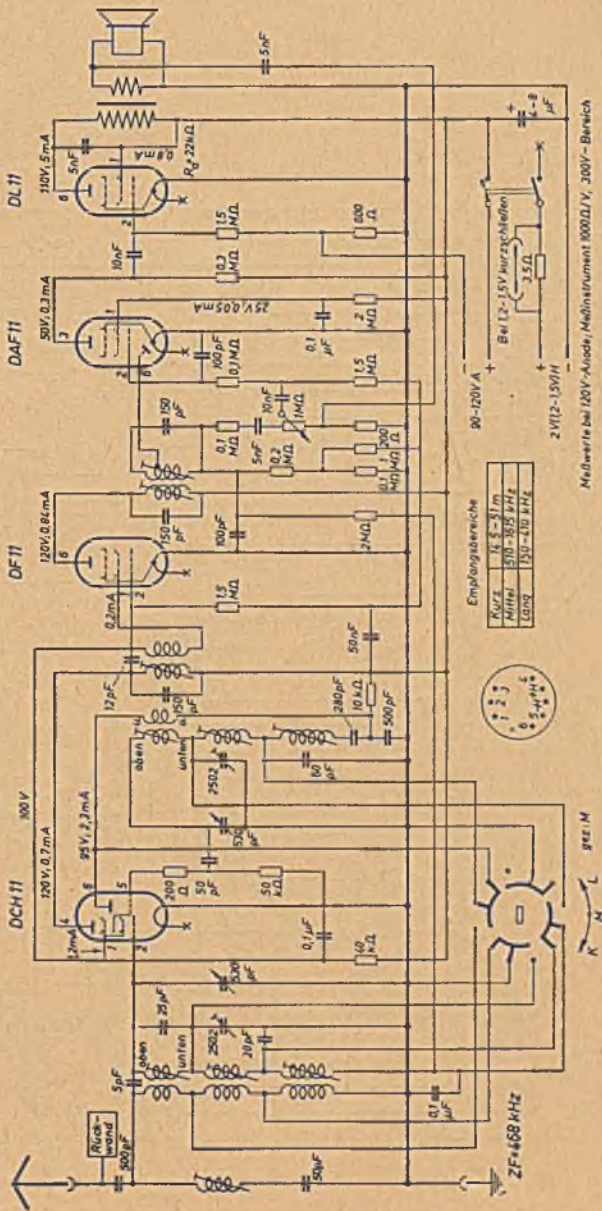

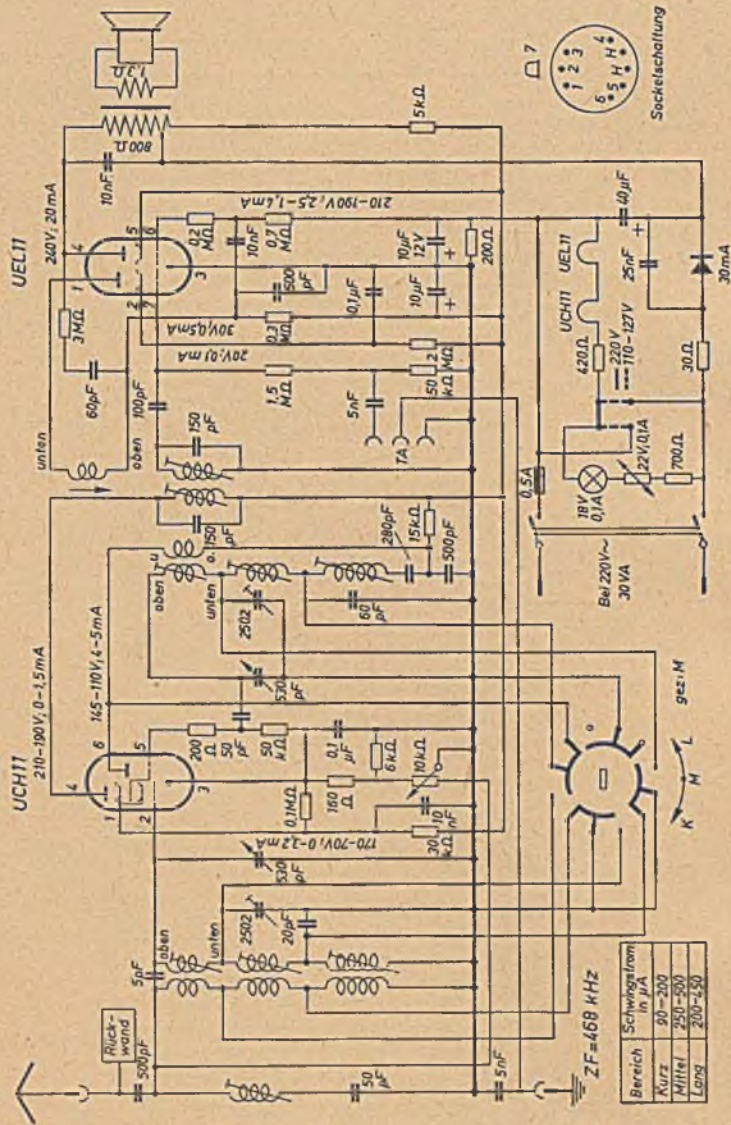

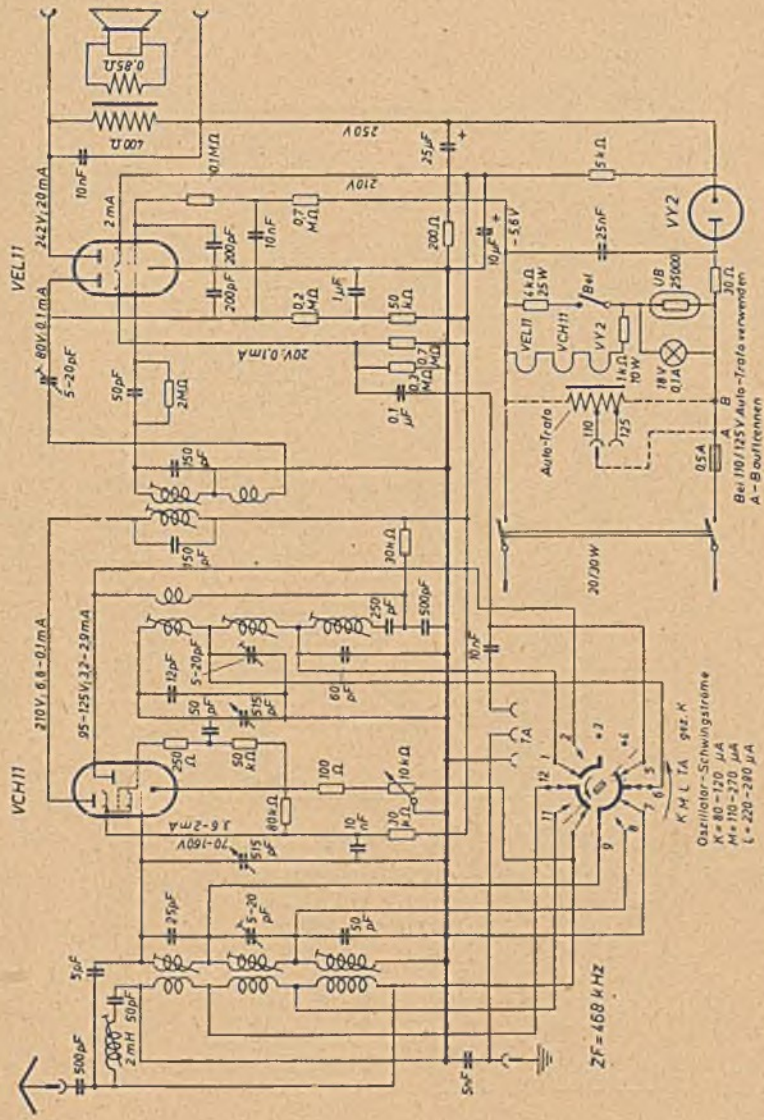

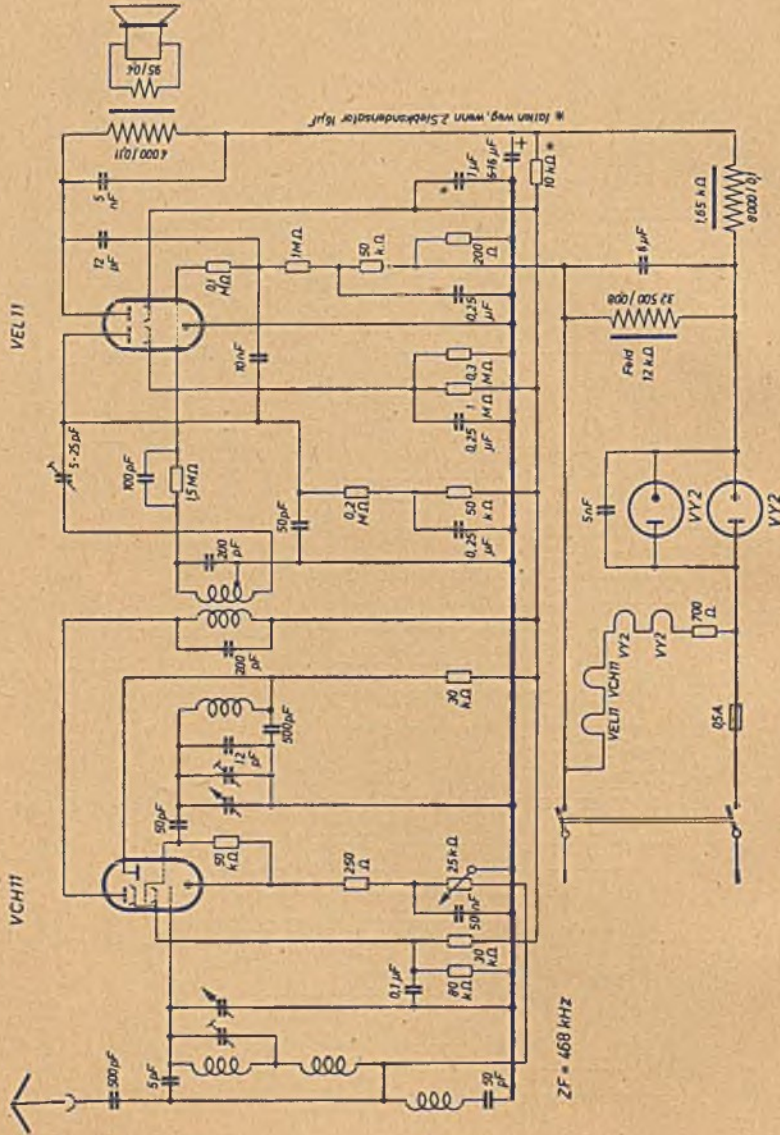

Brandt 150 GW „Kobold“

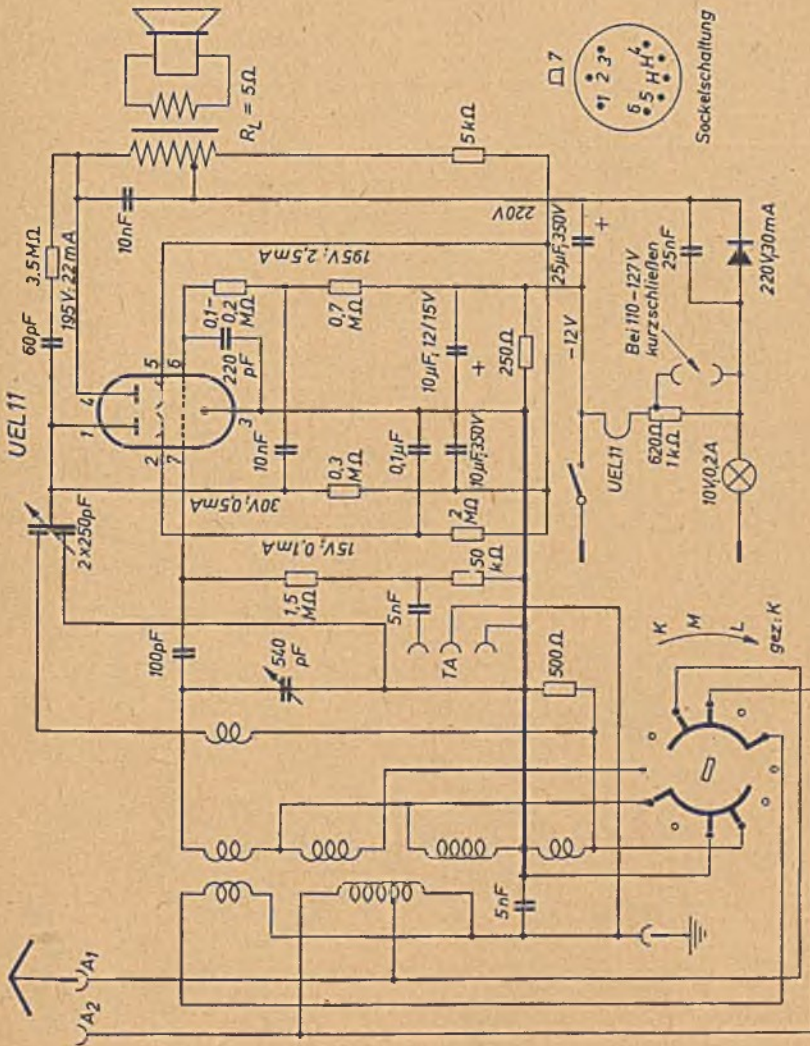

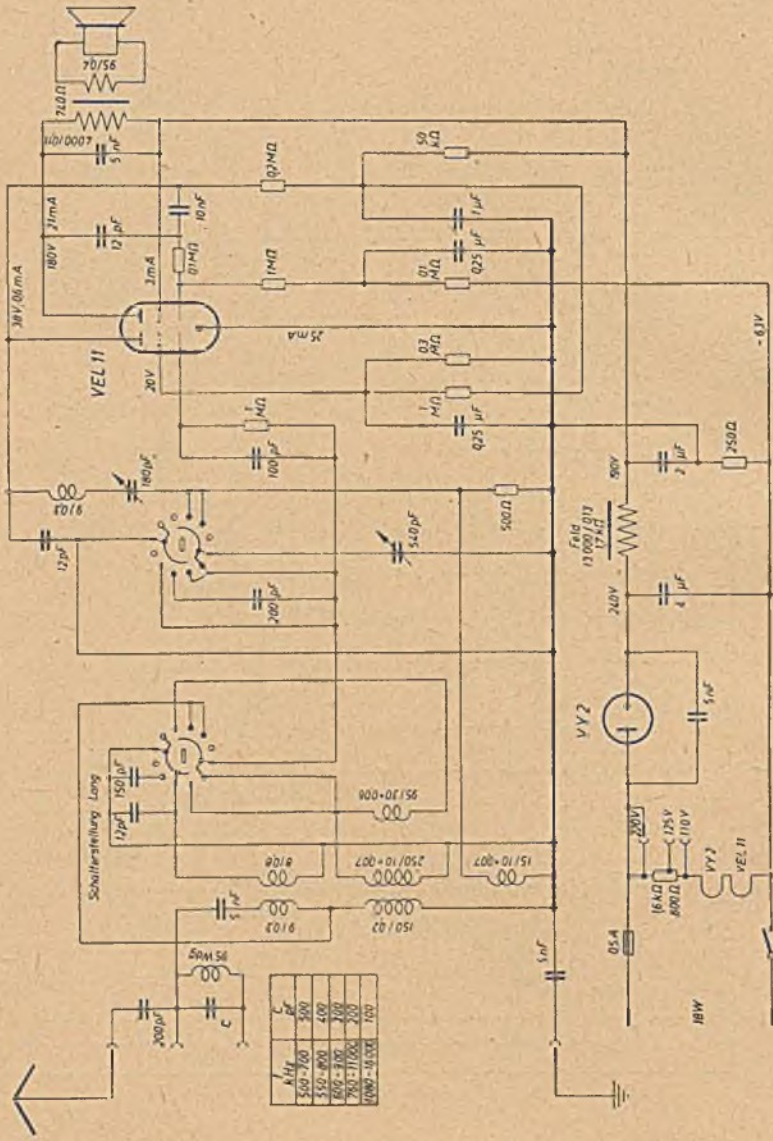

kHz	μF
550-750	500
550-400	400
400-300	300
300-170	200
100-10	100

POLITECHNIKA ŚLĄSKA
Katedra Elektroniki Przemysłowej

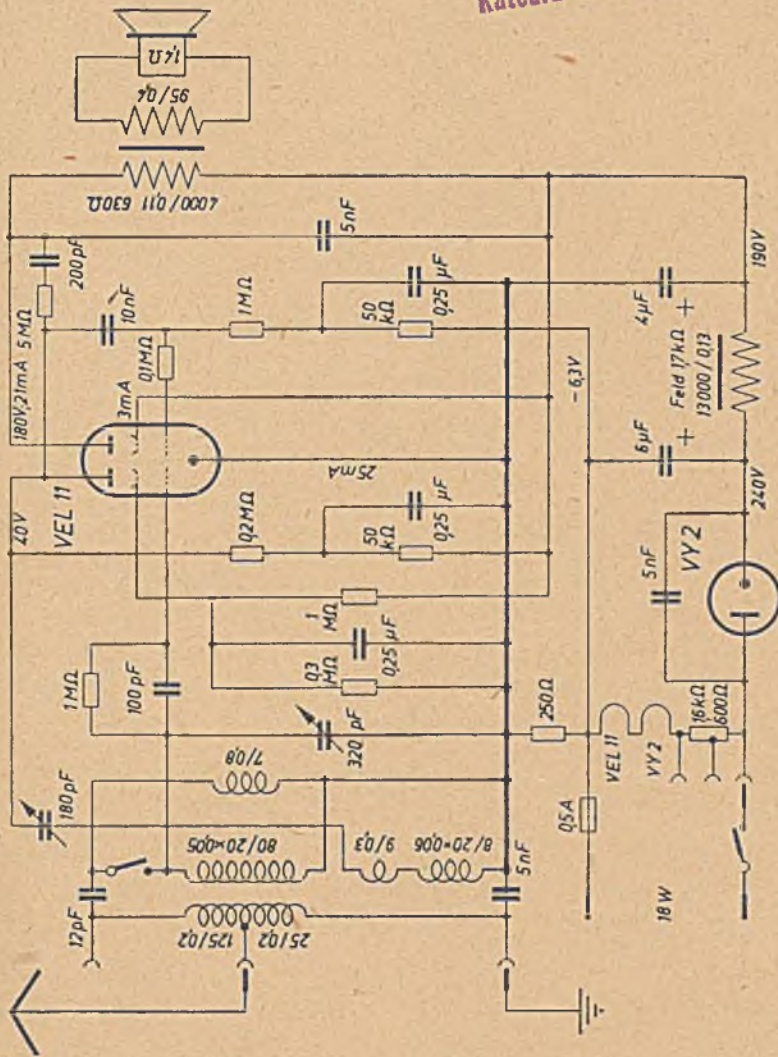

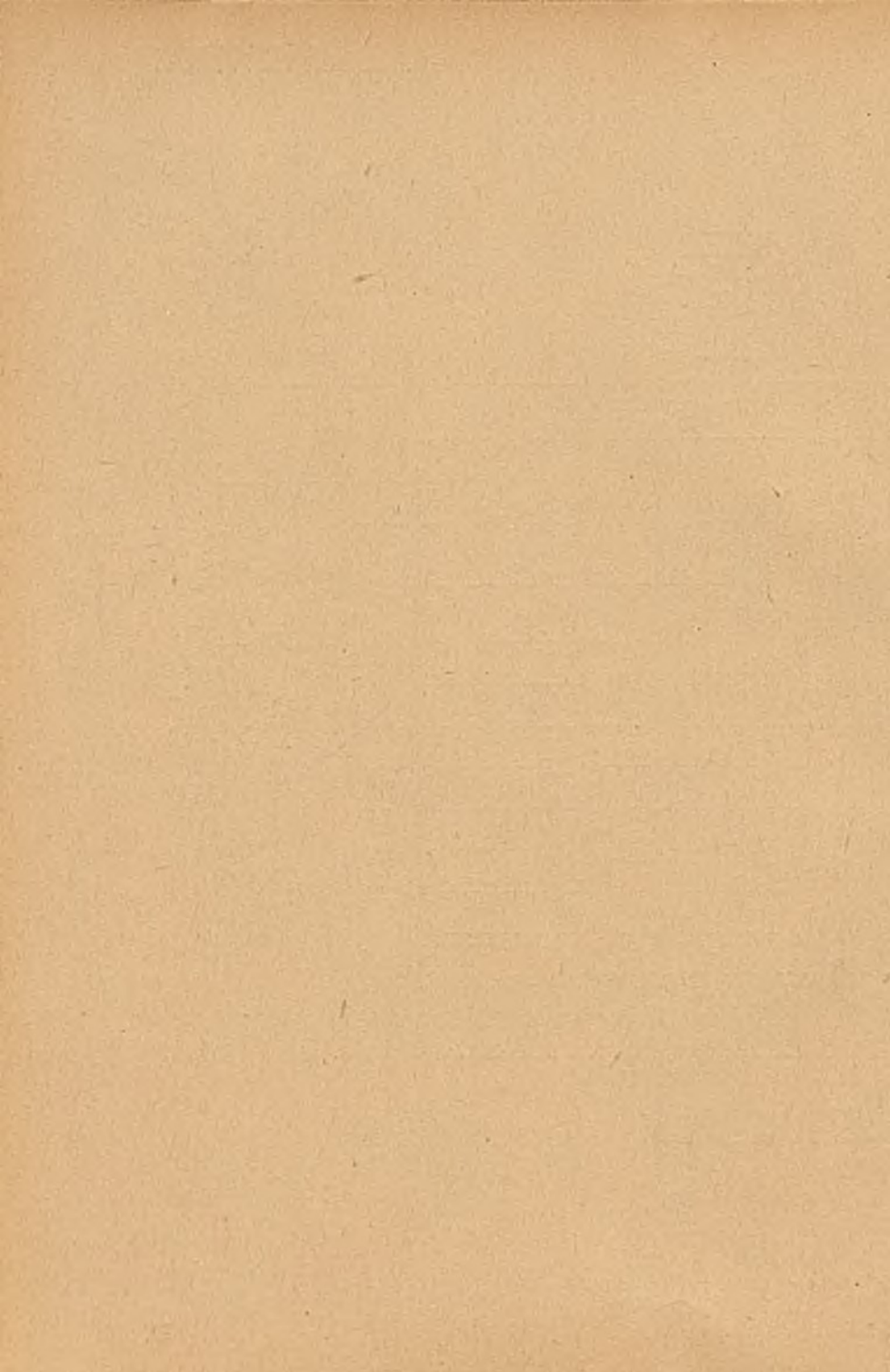

BRANDT
(Produktion vor 1945)



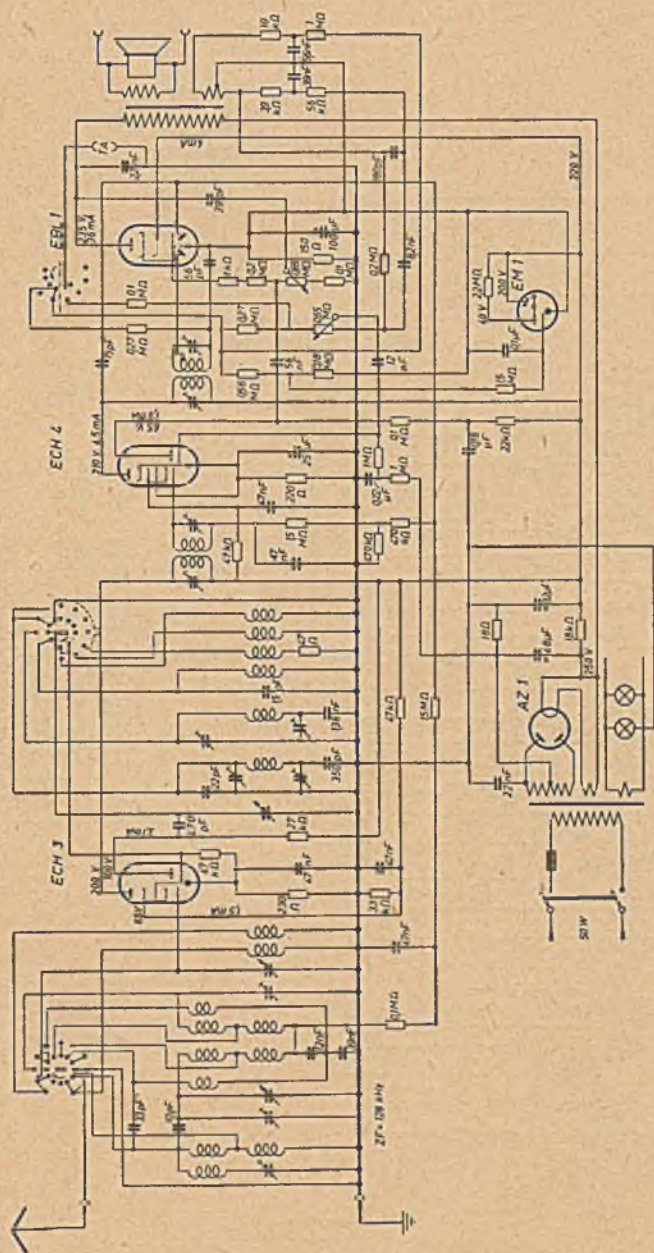

Brandt 217 W Columbus

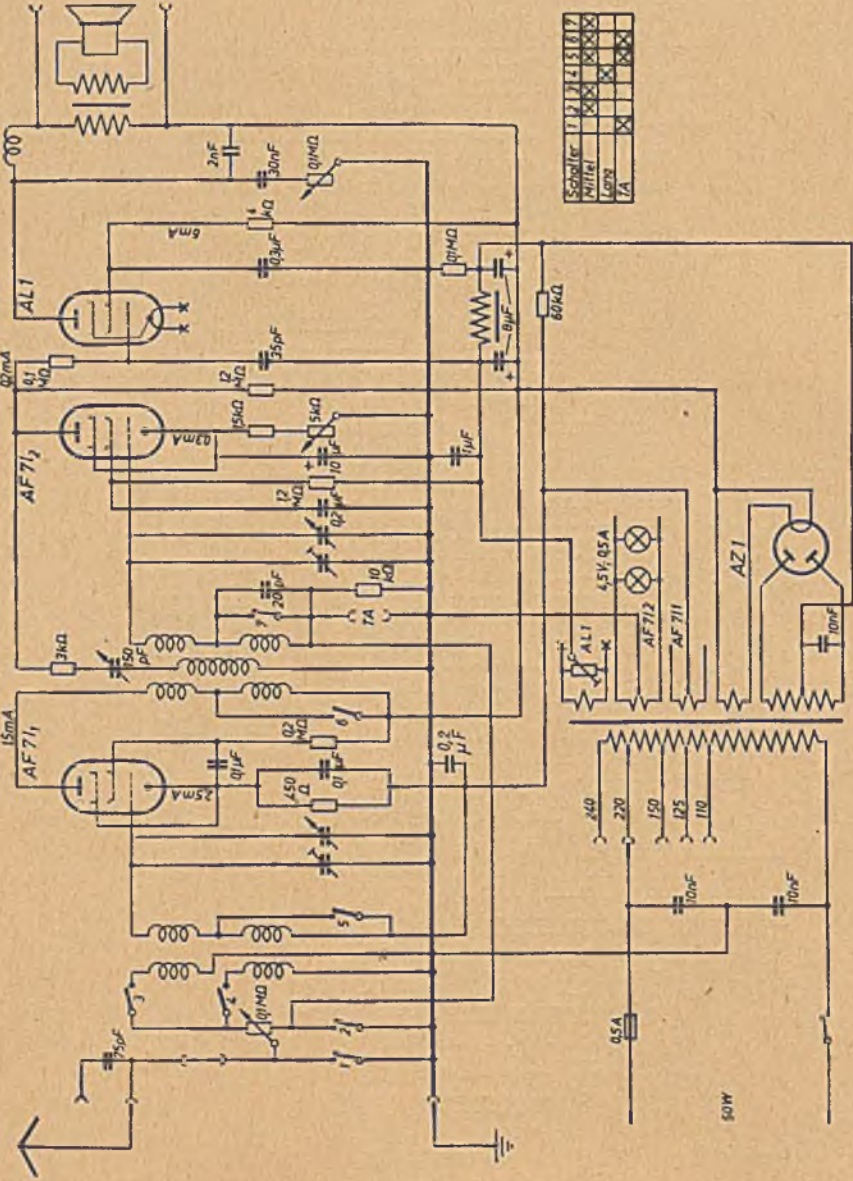

Symbol	1	2	3	4	5	6	7
Schalter	X	X	X	X	X	X	X
Mittel	X	X	X	X	X	X	X
Leuch	X	X	X	X	X	X	X
TA	X	X	X	X	X	X	X

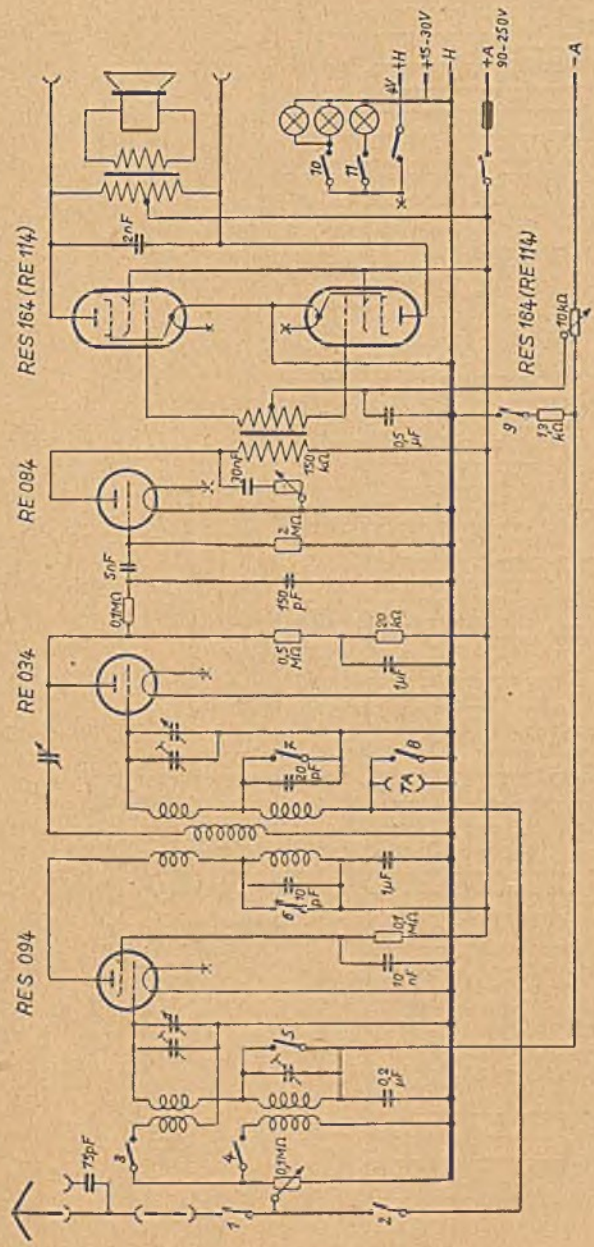

Schalter	1	2	3	4	5	6	7	8	9	10/11
Mittel										
Lang										
TA										

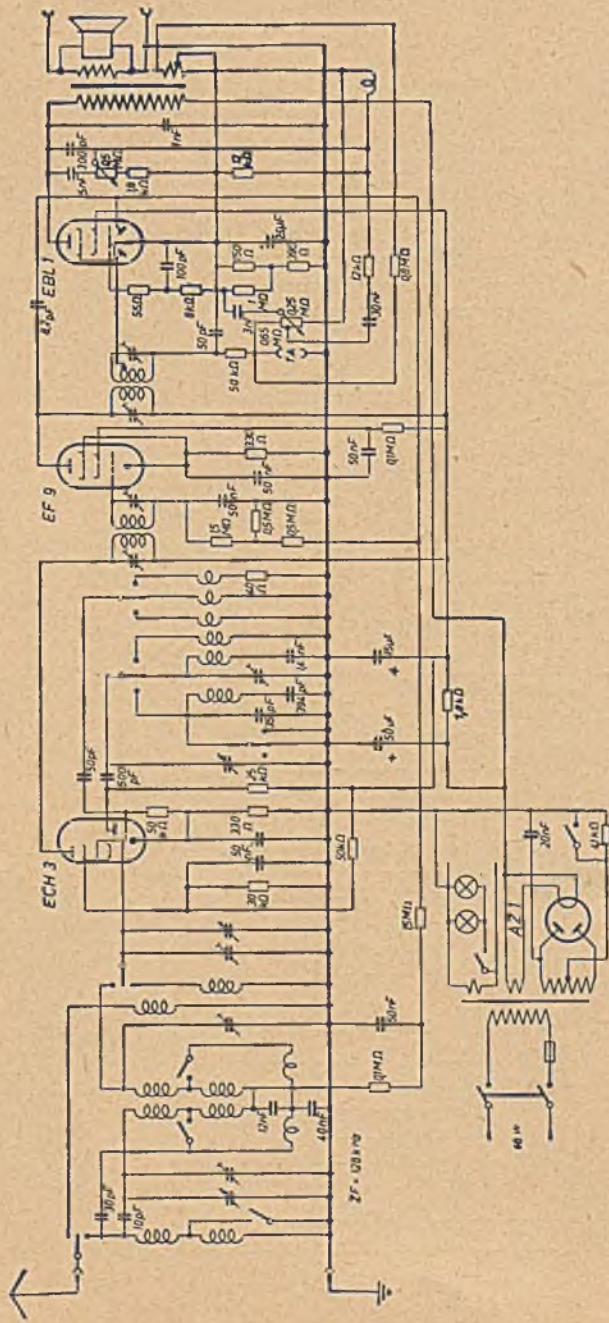

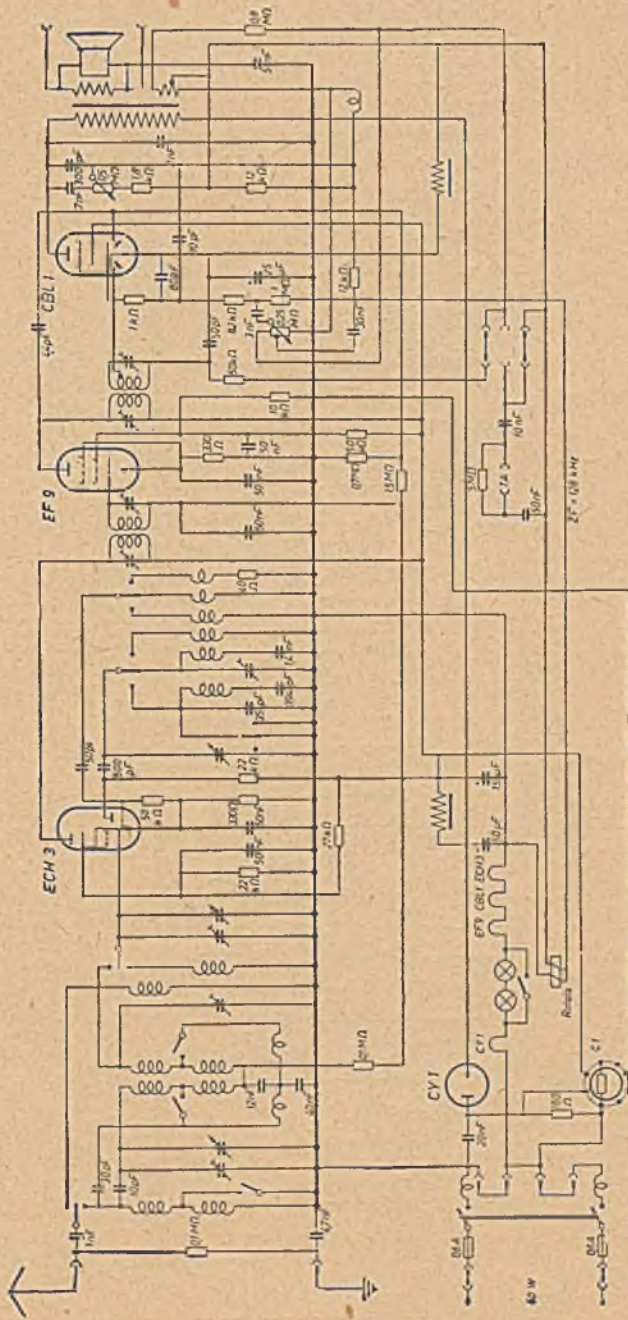

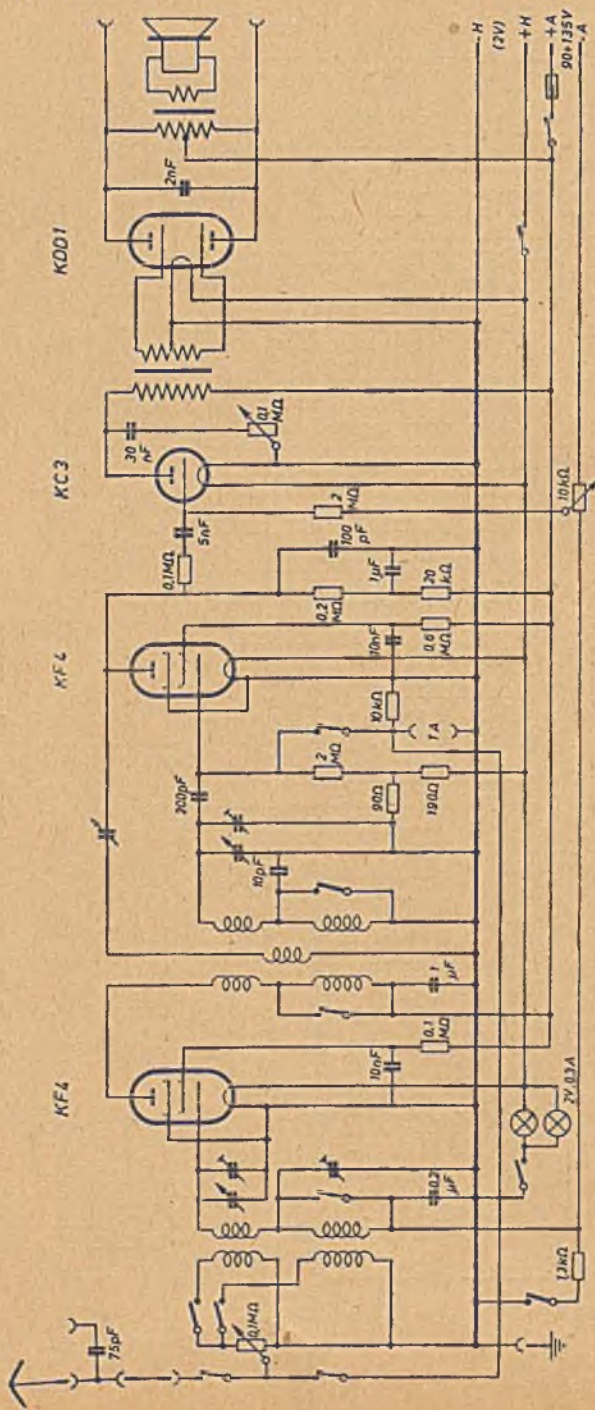

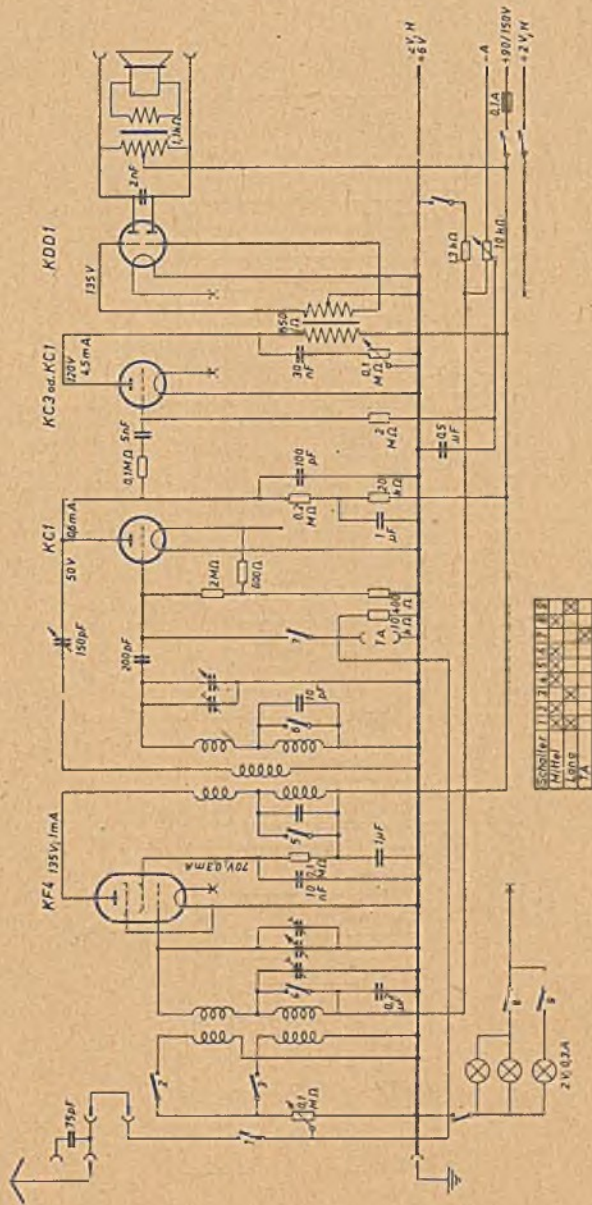

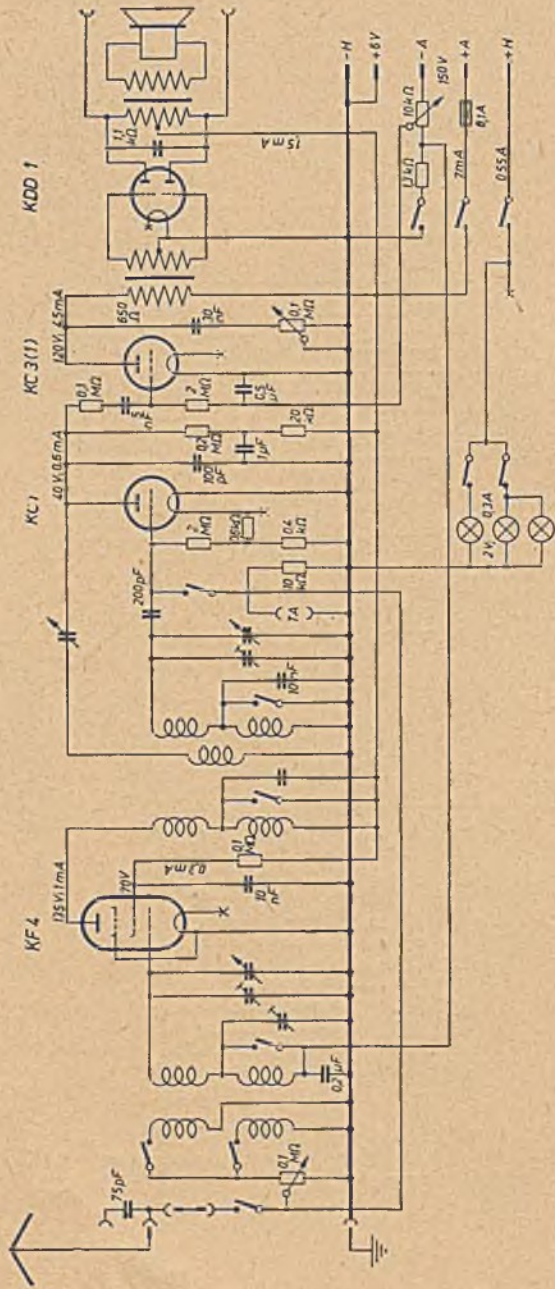

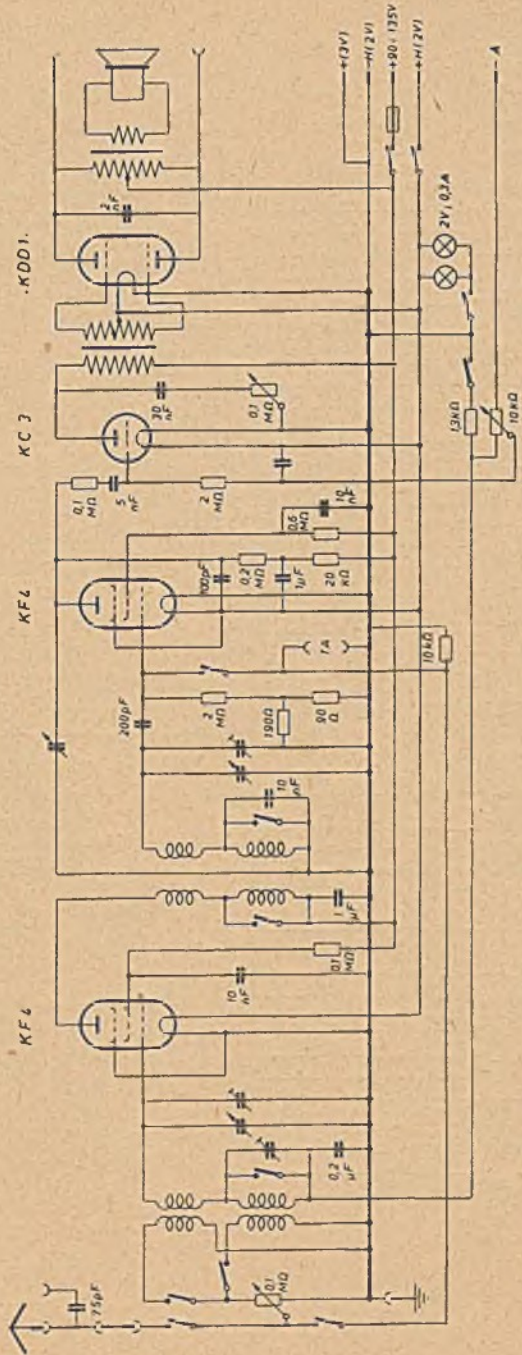

In der Rückkopplungsleitung der Audionröhre **KF 4** liegt zwischen dem Drehkondensator und der Masselinie eine Spule

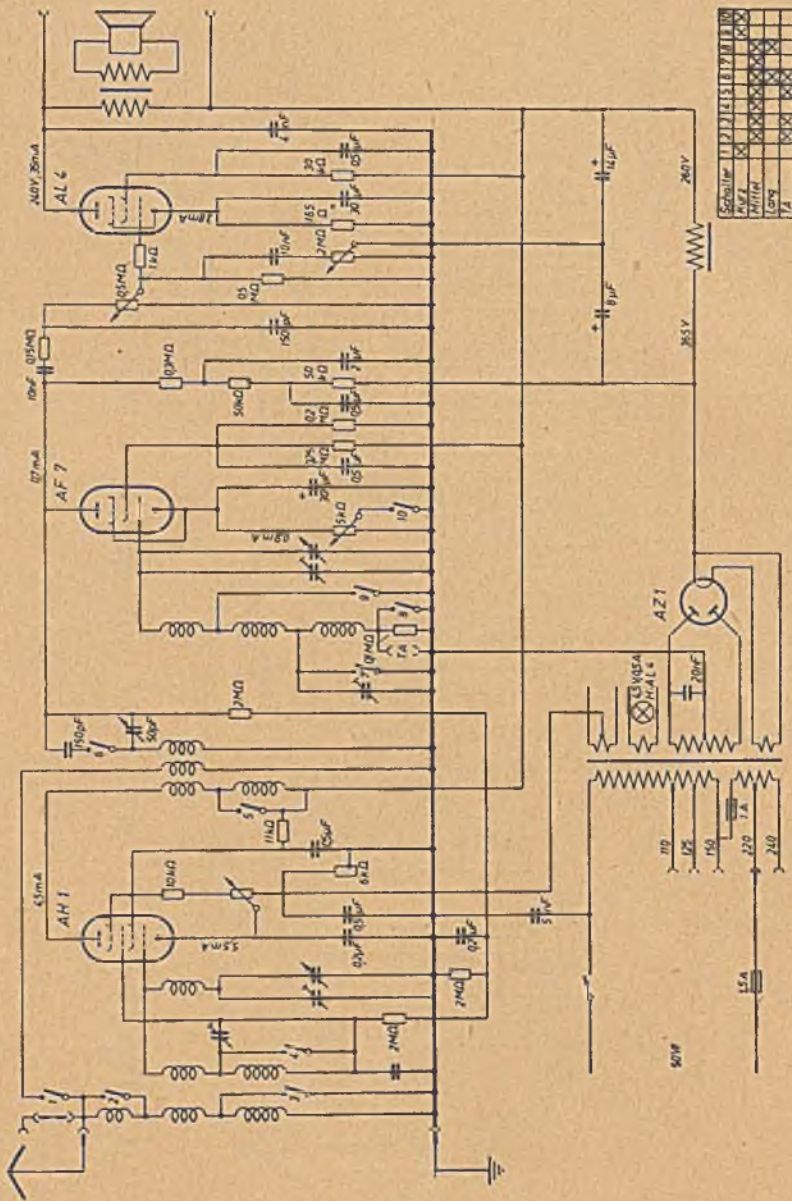

Schalter	1	2	3	4	5	6	7	8	9	10
AKA										
Mittel										
Lanz										
TA										

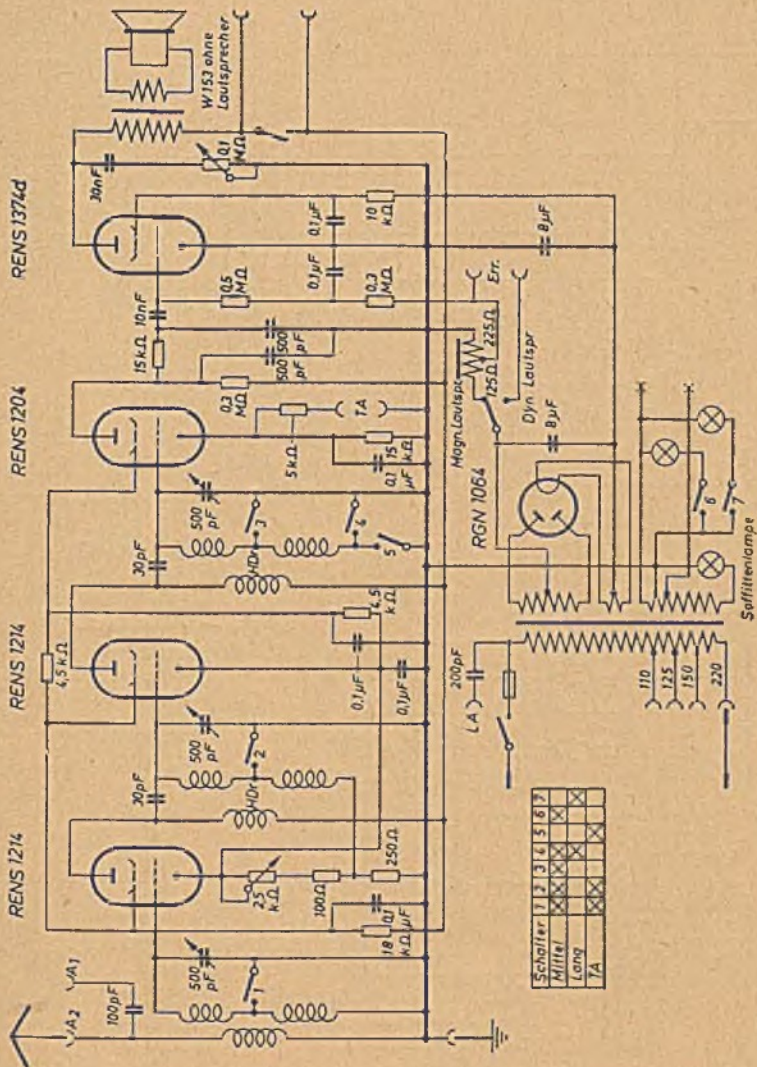

Brandt 170-2/2 Columbus

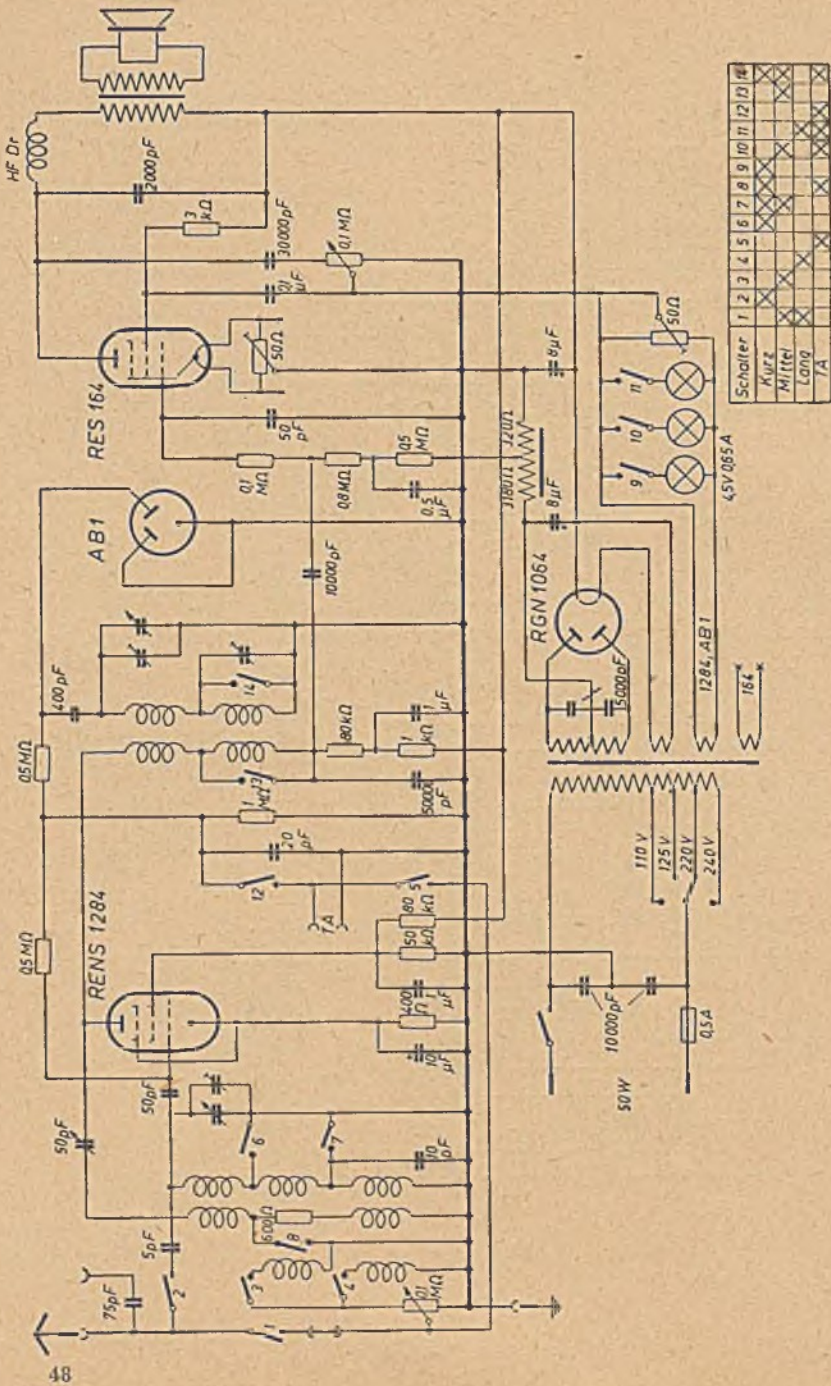

Schalter	1	2	3	4	5	6	7	8	9	10	11	12	13	14	
Kurz	X	X	X	X	X	X	X	X	X	X	X	X	X	X	X
Mittel	X	X	X	X	X	X	X	X	X	X	X	X	X	X	X
Lang	X	X	X	X	X	X	X	X	X	X	X	X	X	X	X
T/A	X	X	X	X	X	X	X	X	X	X	X	X	X	X	X

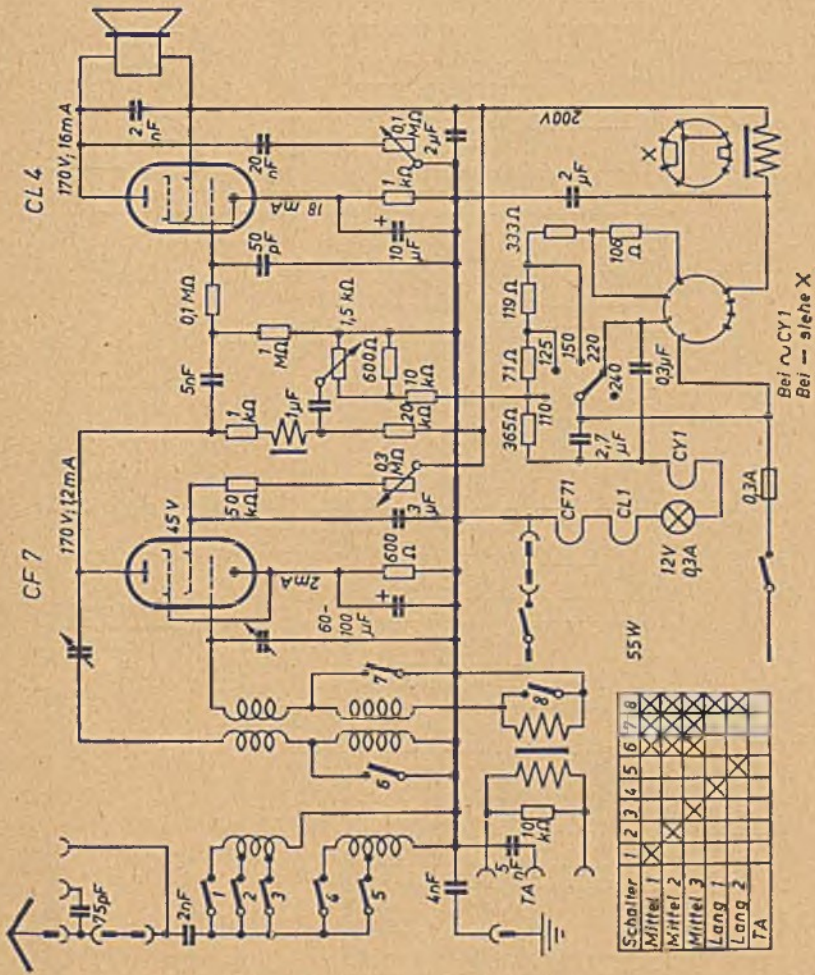

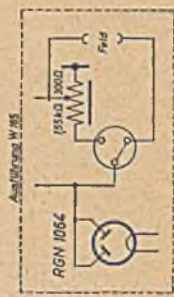
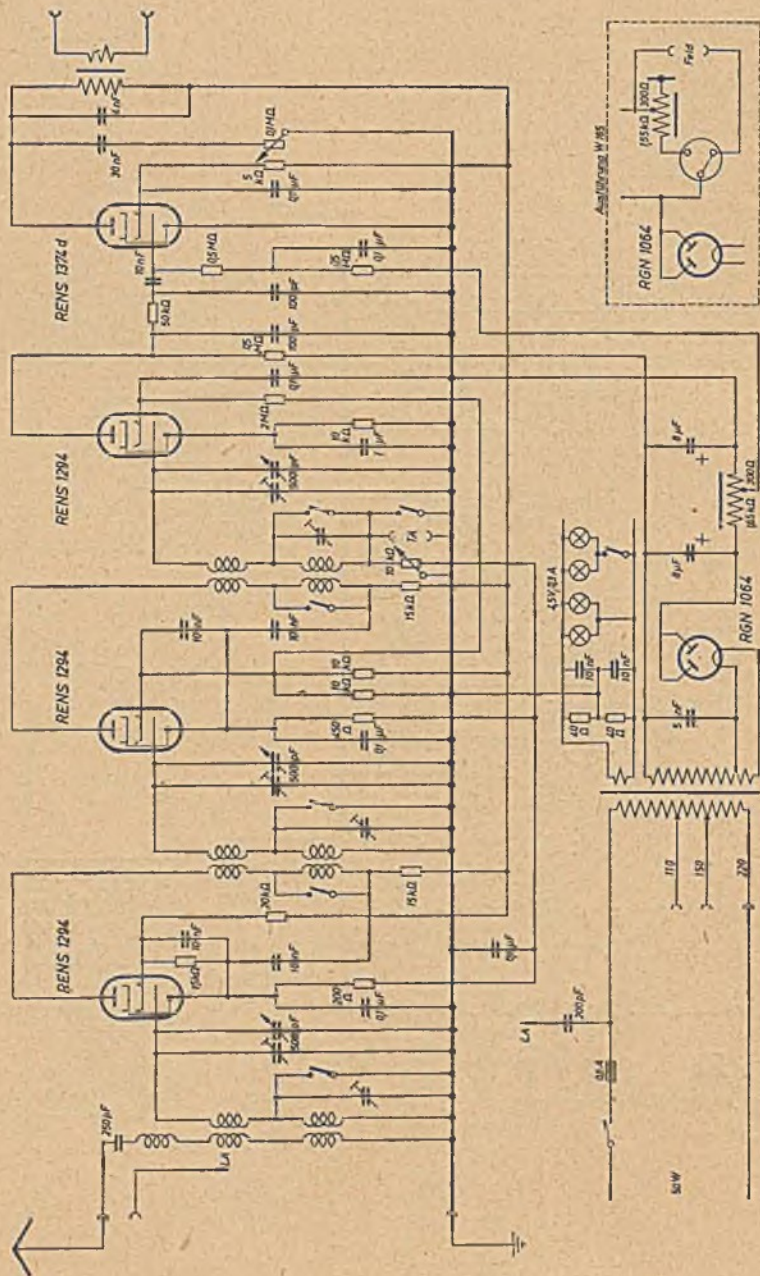

Spekter	1	2	3	4	5	6	7	8
Mittel I	X	X	X	X	X	X	X	X
Mittel II	X	X	X	X	X	X	X	X
Mittel III	X	X	X	X	X	X	X	X
Lang I	X	X	X	X	X	X	X	X
Lang II	X	X	X	X	X	X	X	X
TA								

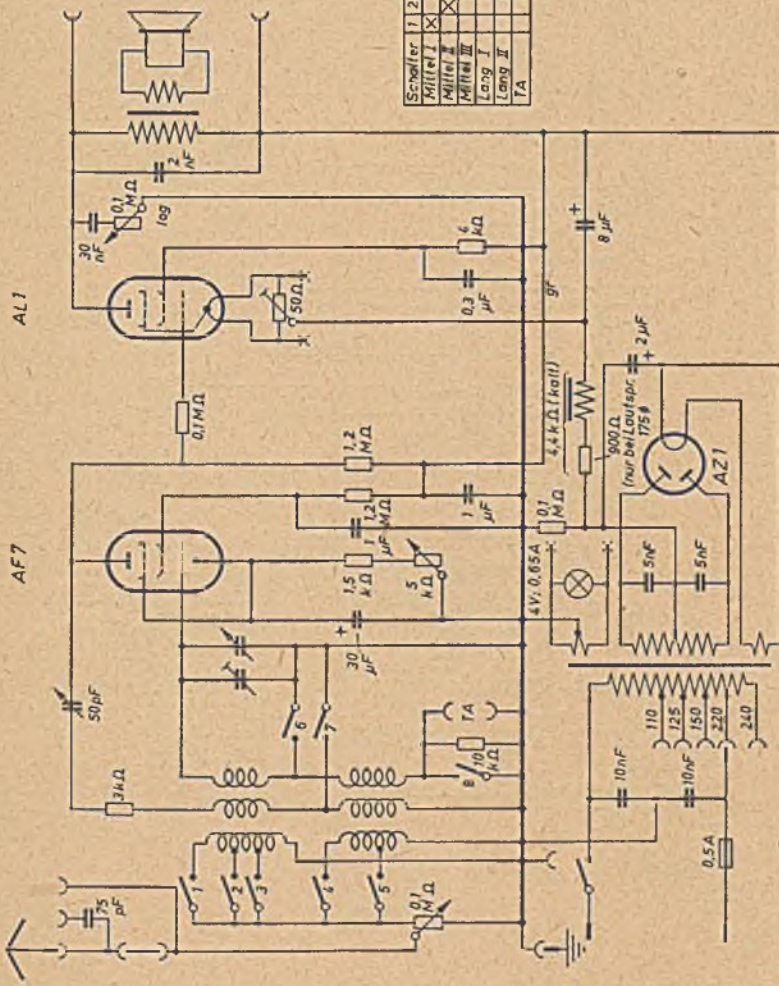

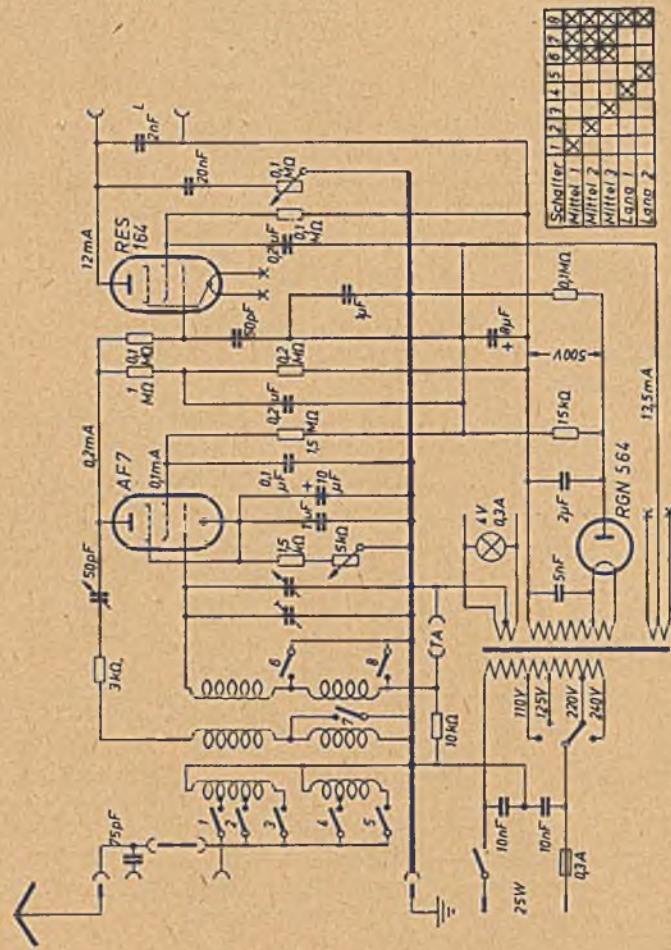

Schalter 1																				
Mittel 1																				
Mittel 2																				
Lage 1																				
Lage 2																				

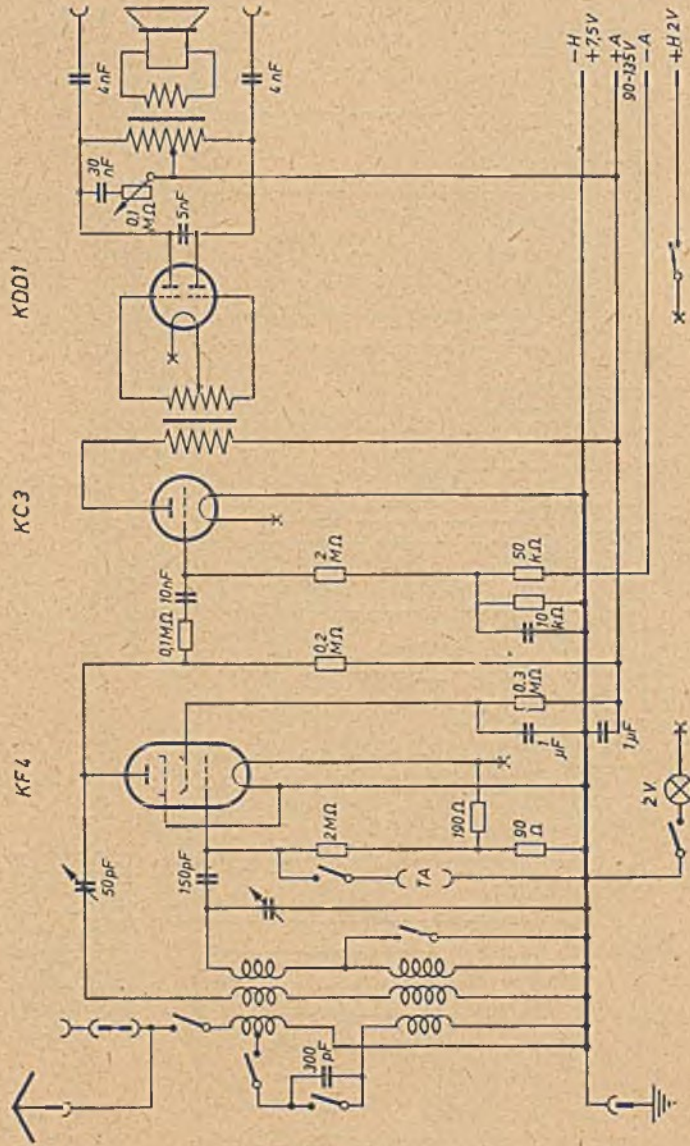

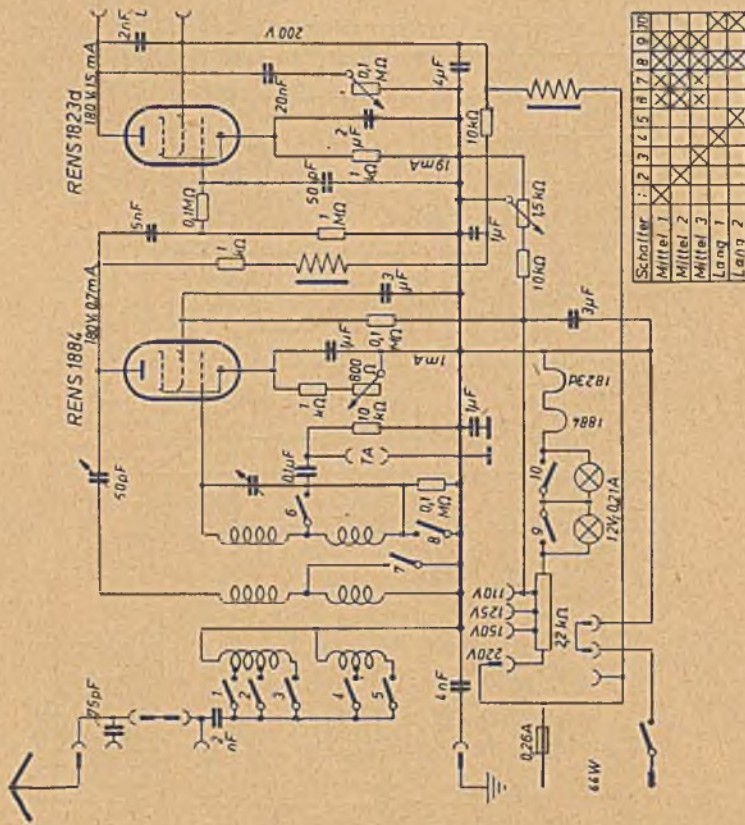

Schalter 1	1	2	3	4	5	6	7	8	9	10
Mittel 1	X	X	X	X	X	X	X	X	X	X
Mittel 2	X	X	X	X	X	X	X	X	X	X
Mittel 3	X	X	X	X	X	X	X	X	X	X
Lang 1	X	X	X	X	X	X	X	X	X	X
Lang 2	X	X	X	X	X	X	X	X	X	X

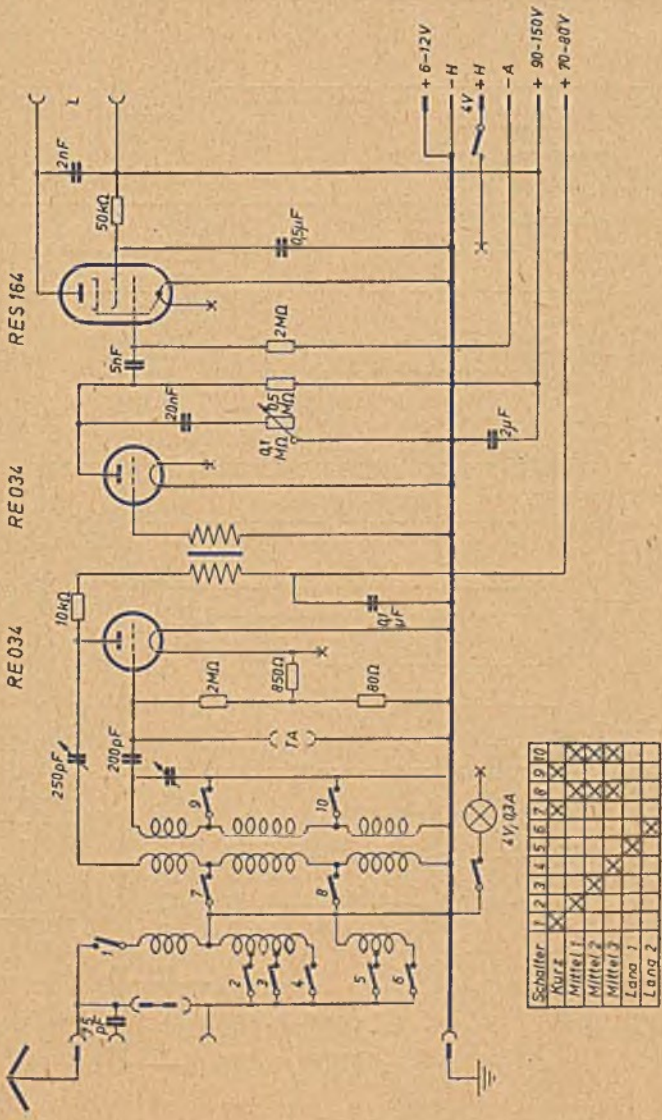

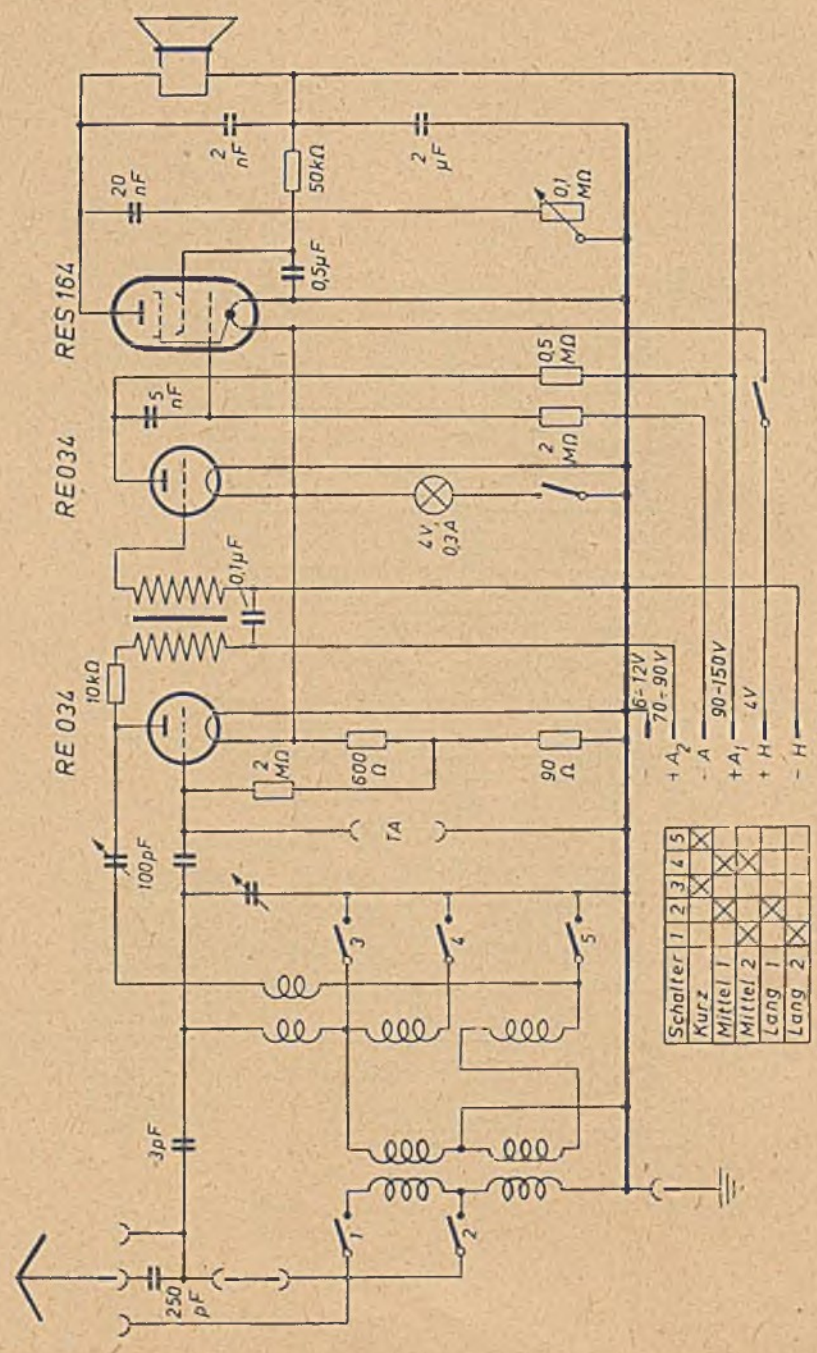

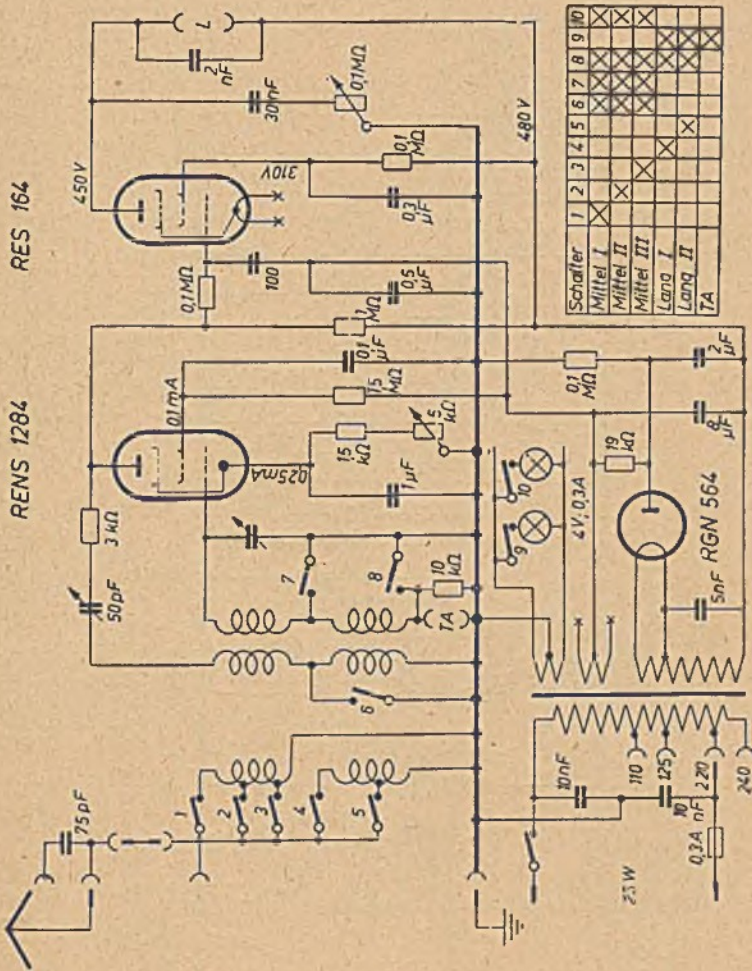

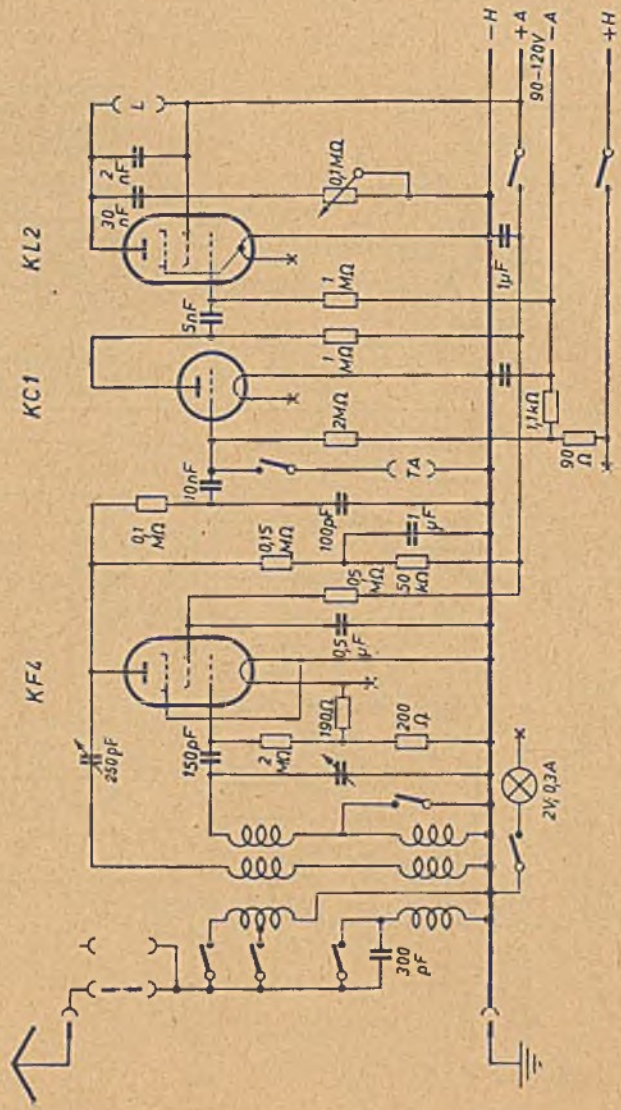

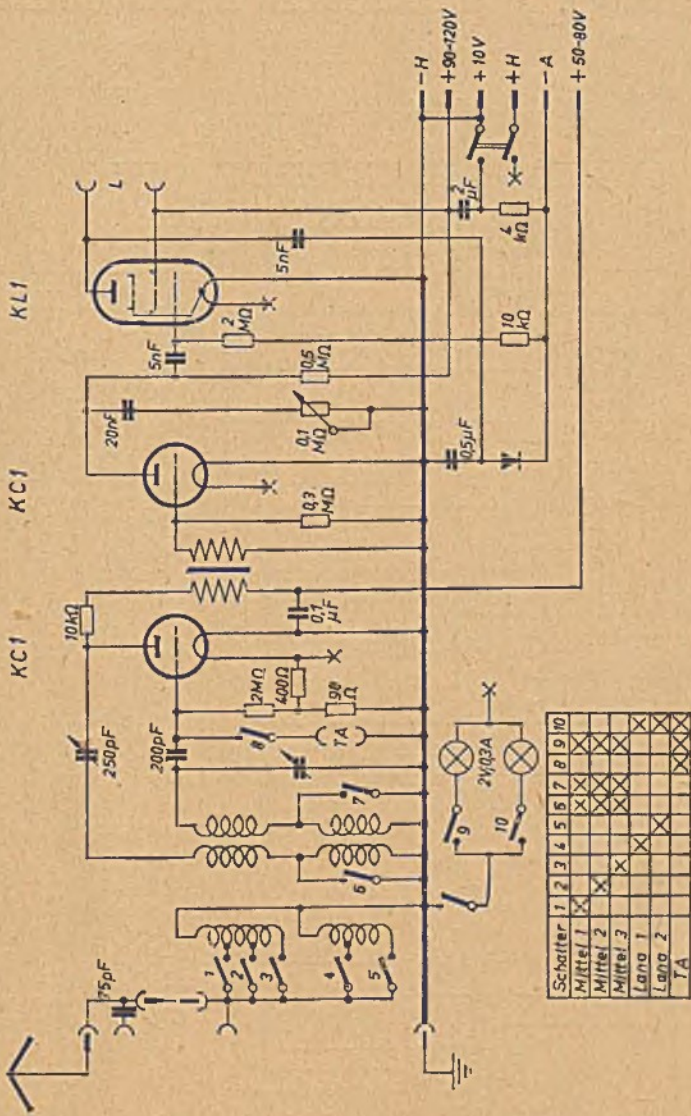

Schalter	1	2	3	4	5	6	7	8	9	10
Mittel 1	X									
Mittel 2		X								
Mittel 3			X							
Lana 1				X						
Lana 2					X					
TA						X				

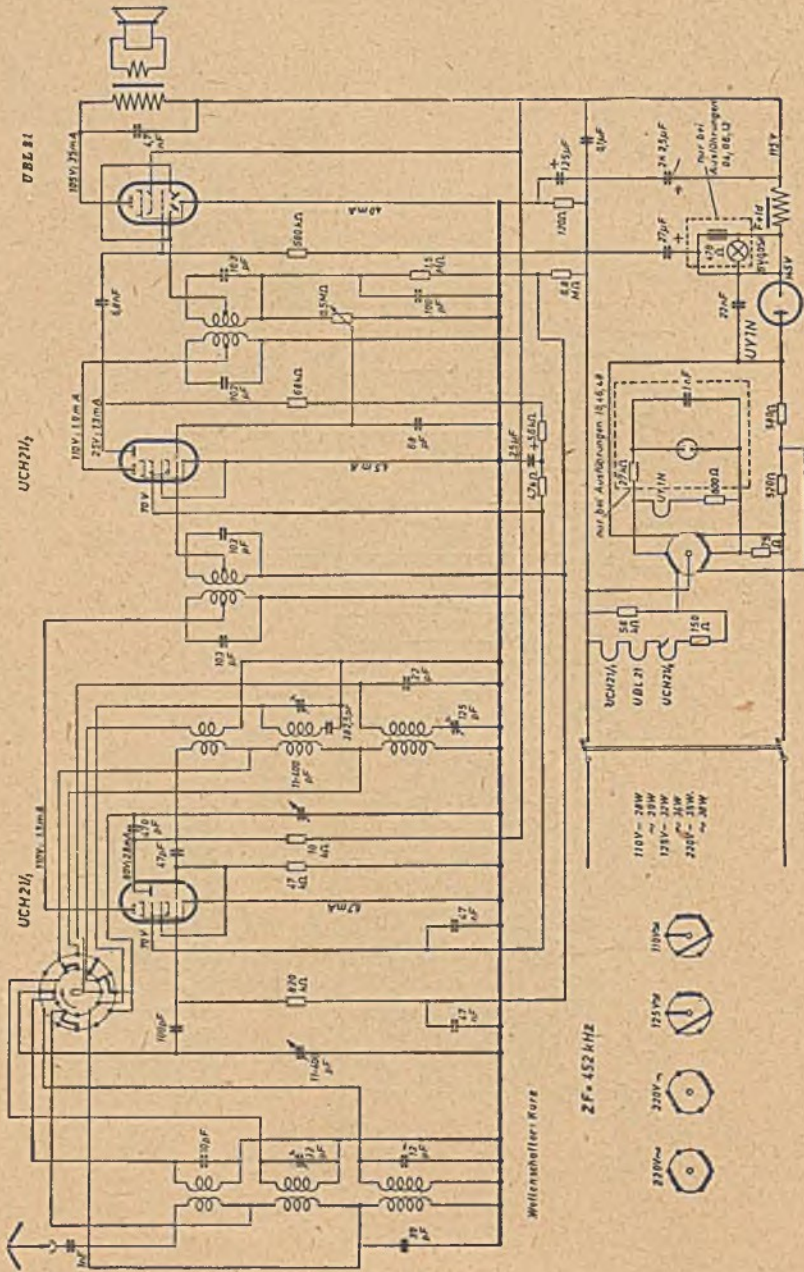

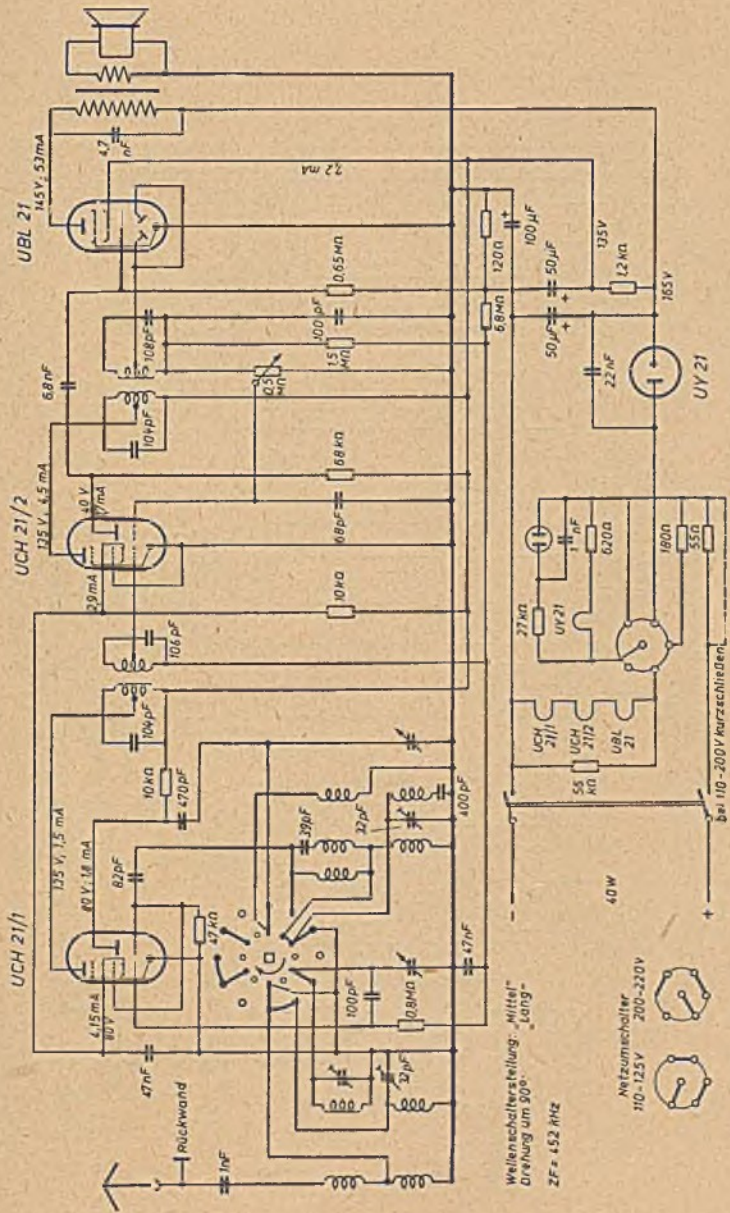

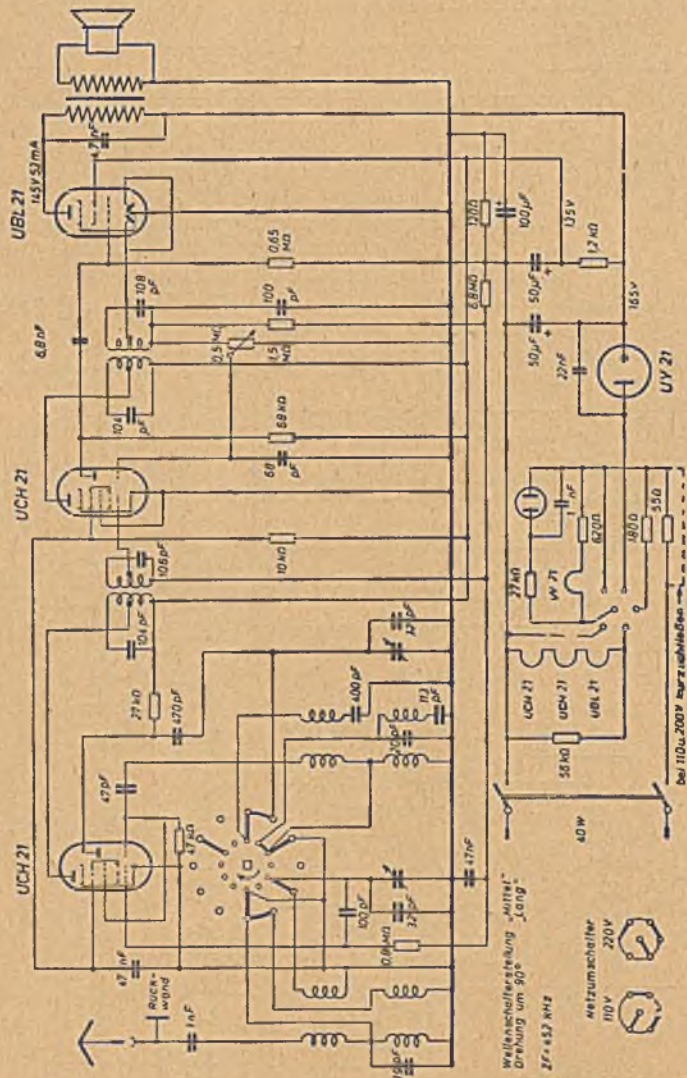

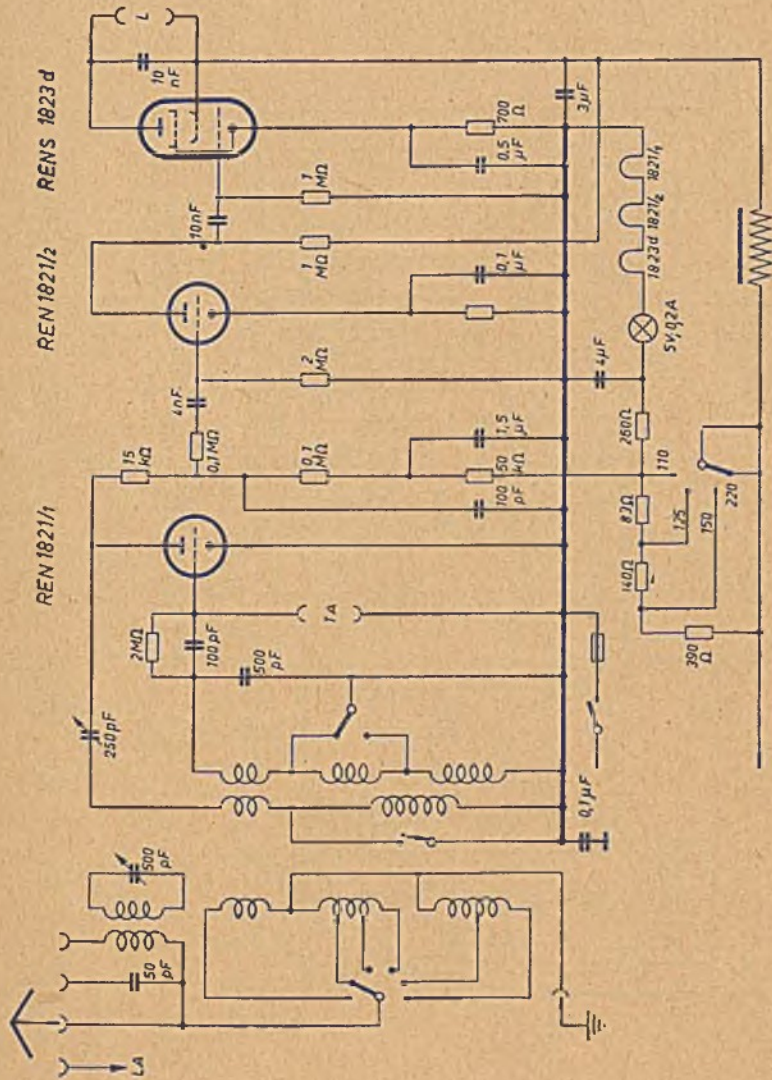

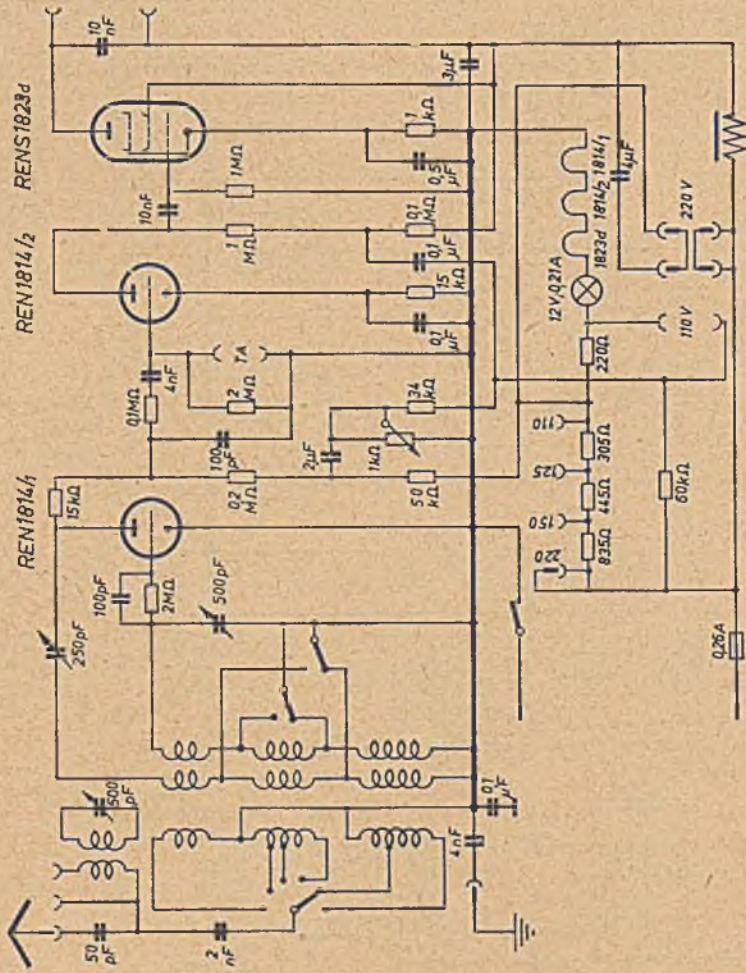

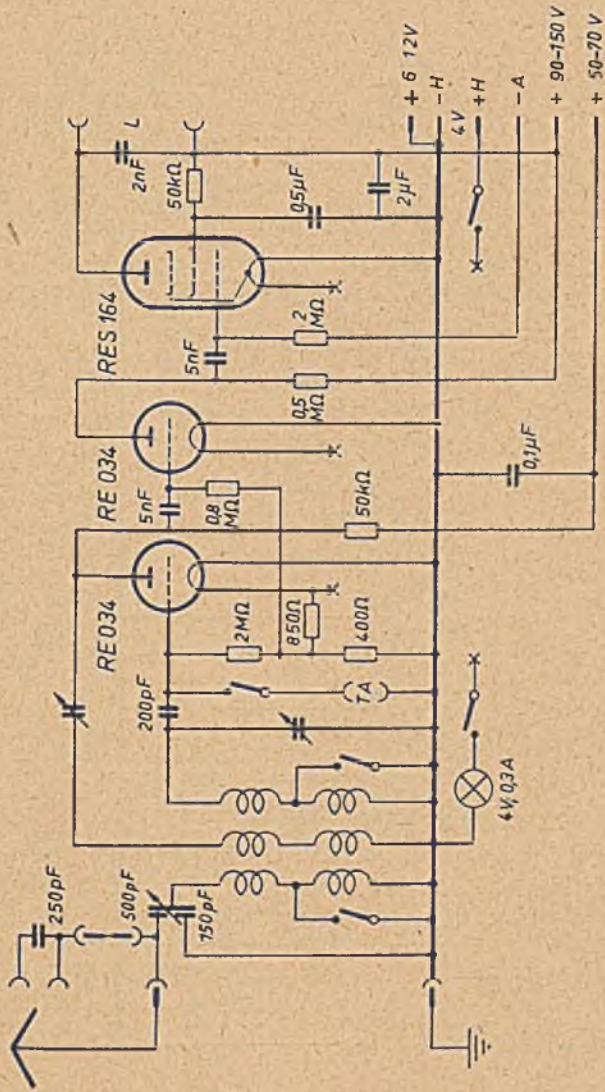

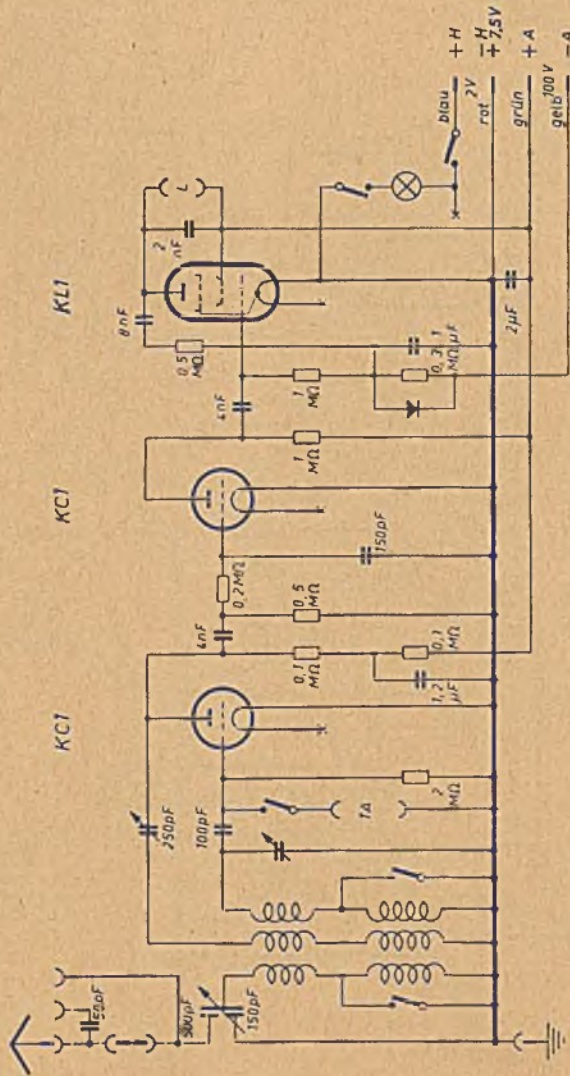

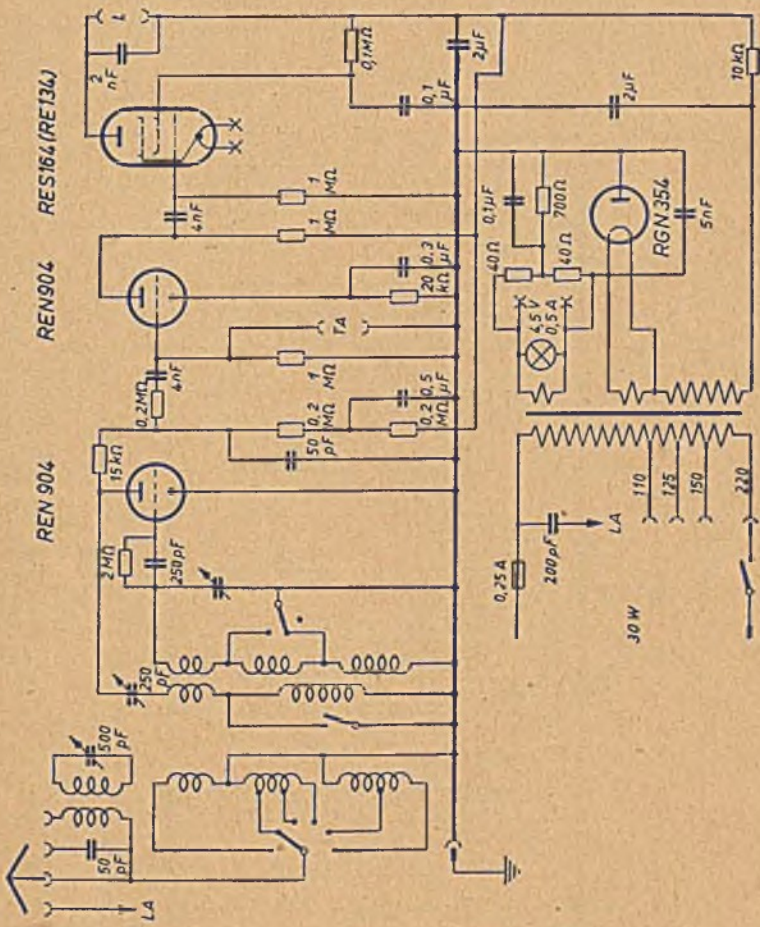

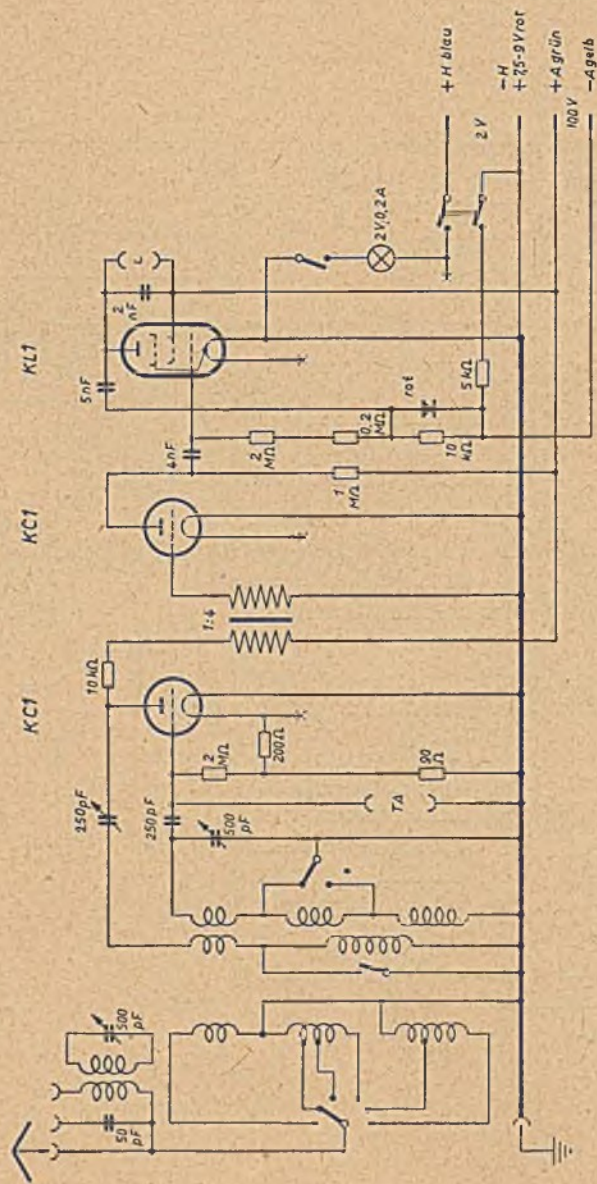

Brandt 76 Columbus

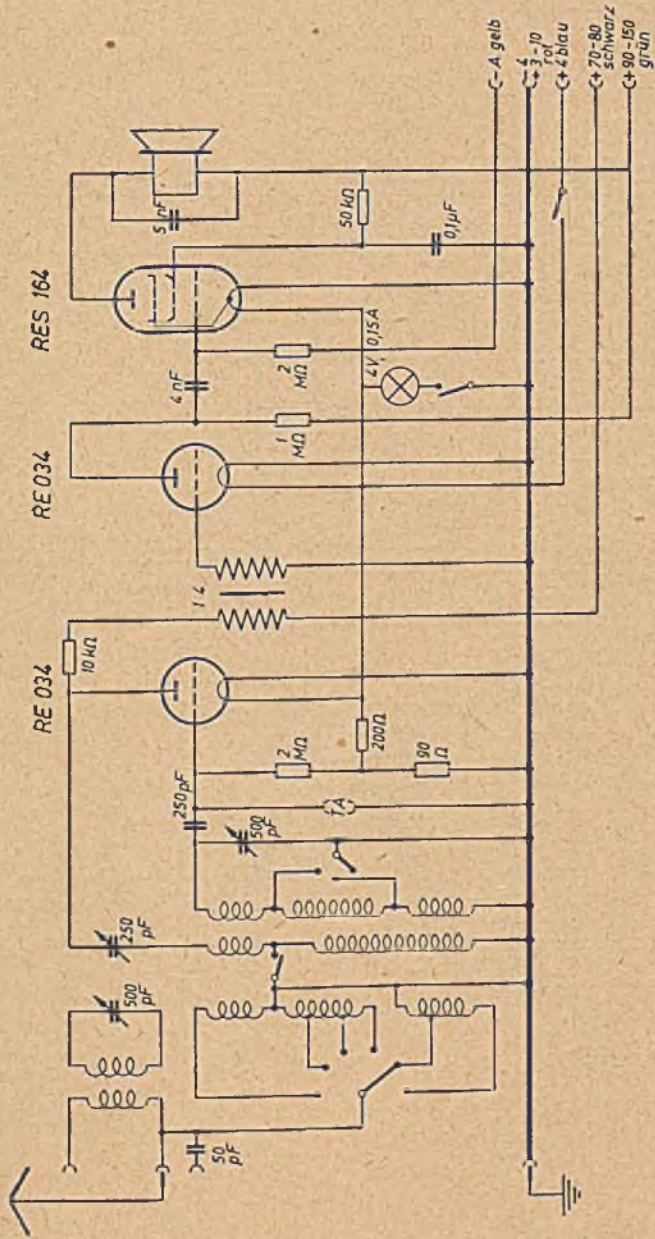

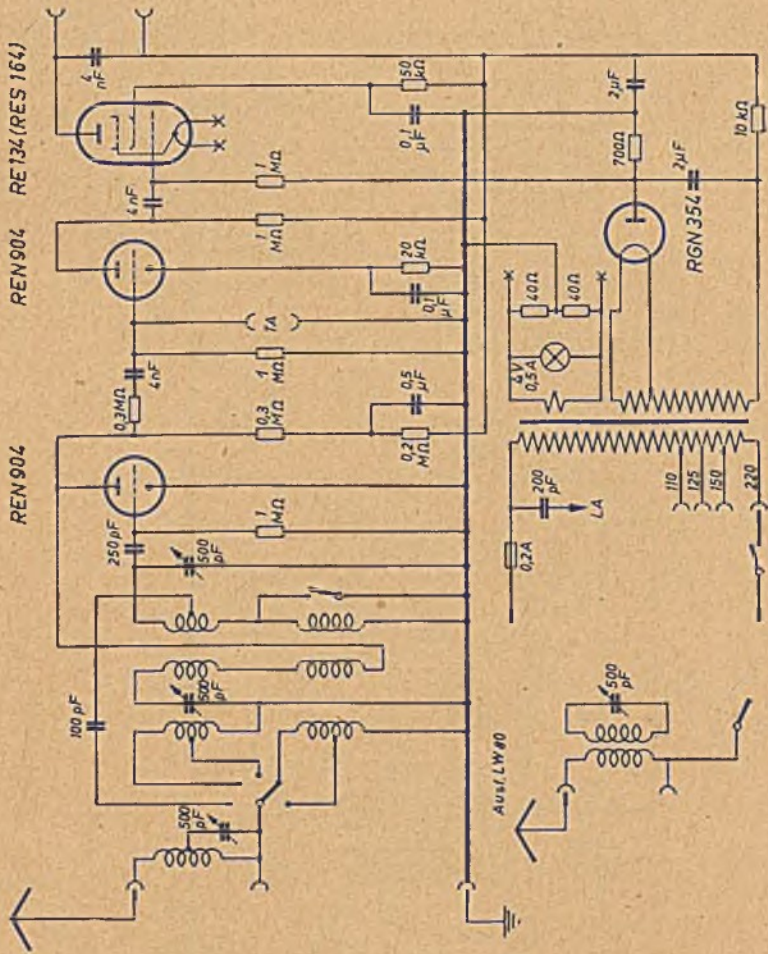

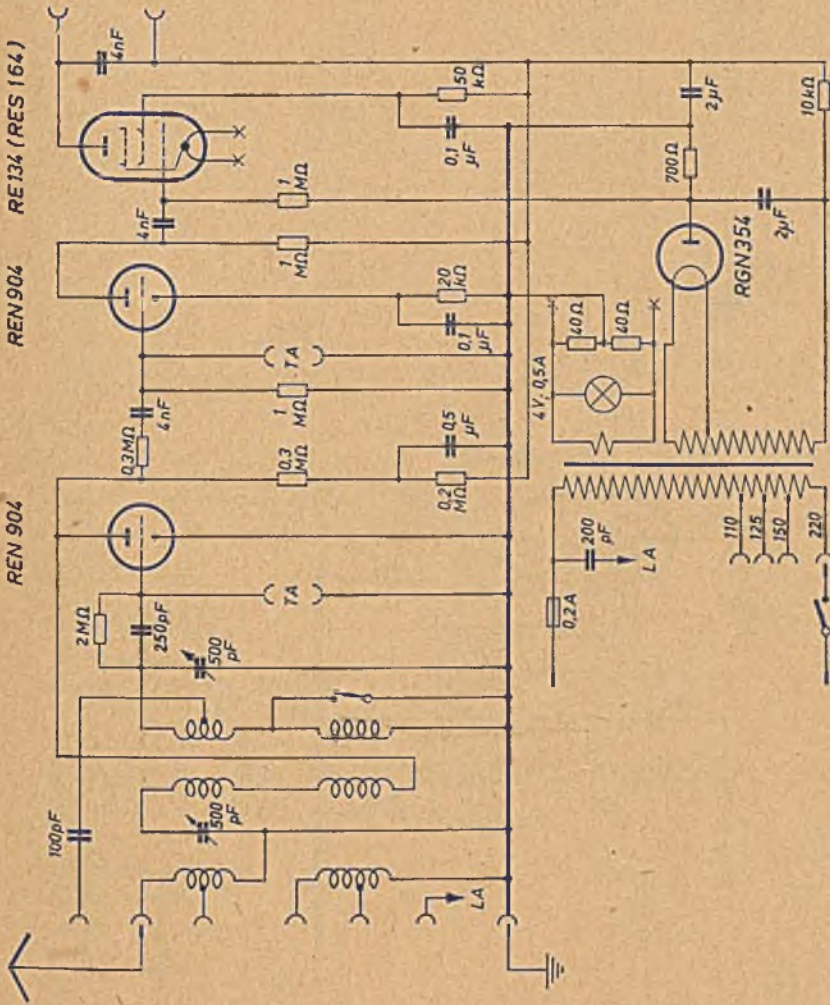

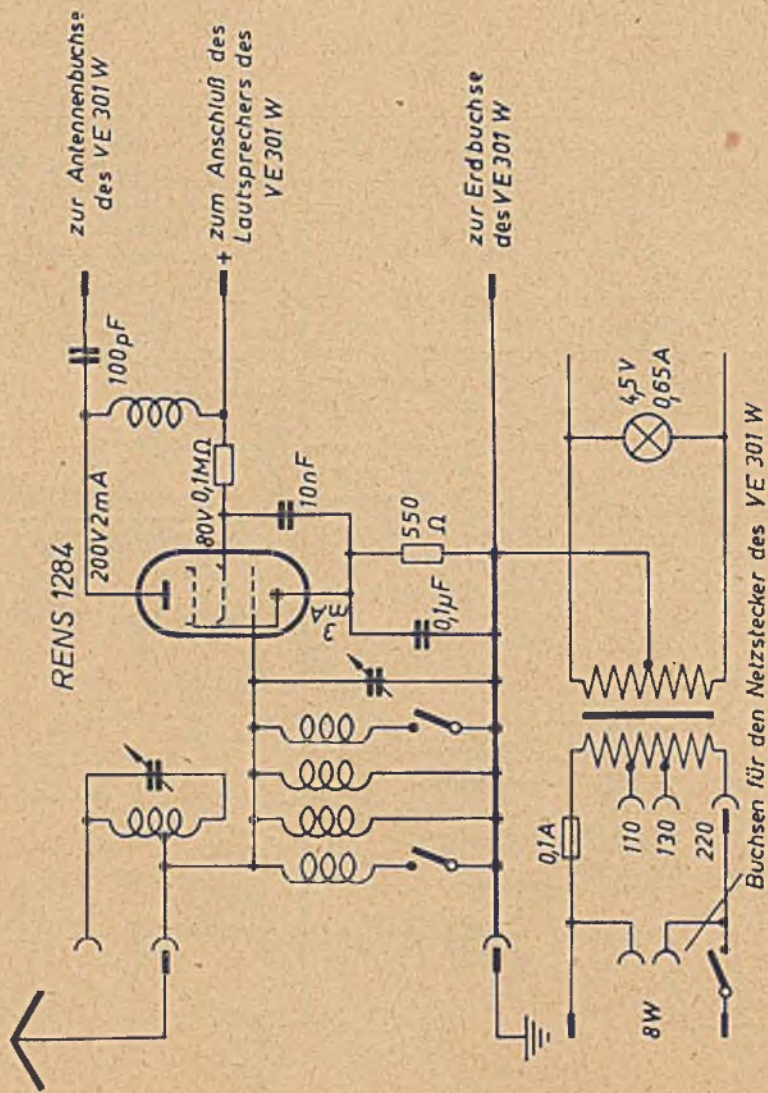

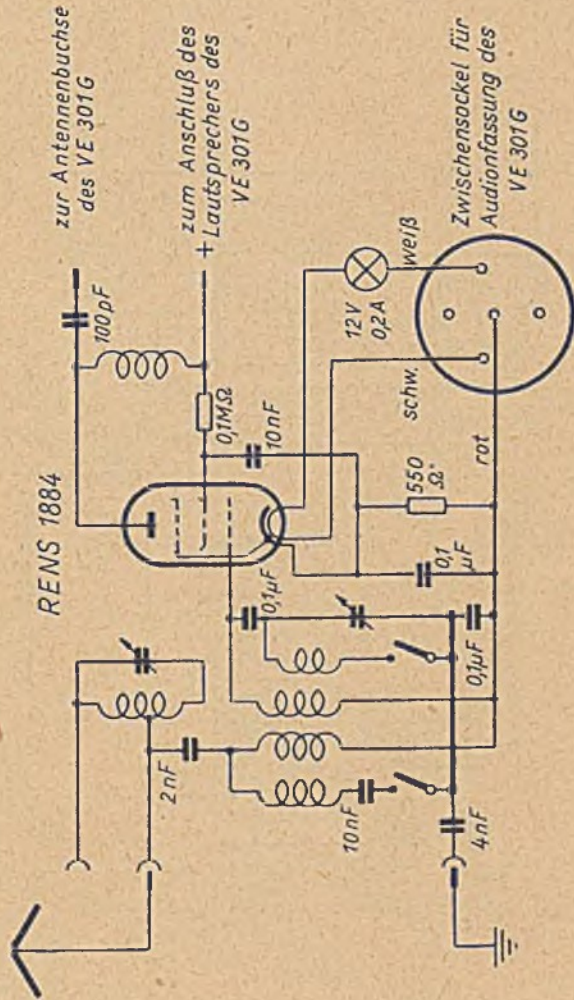

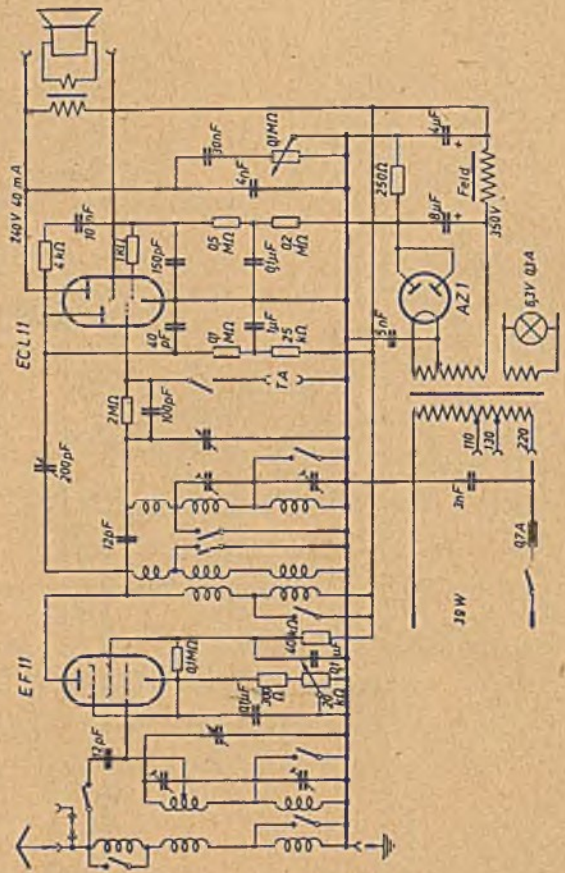

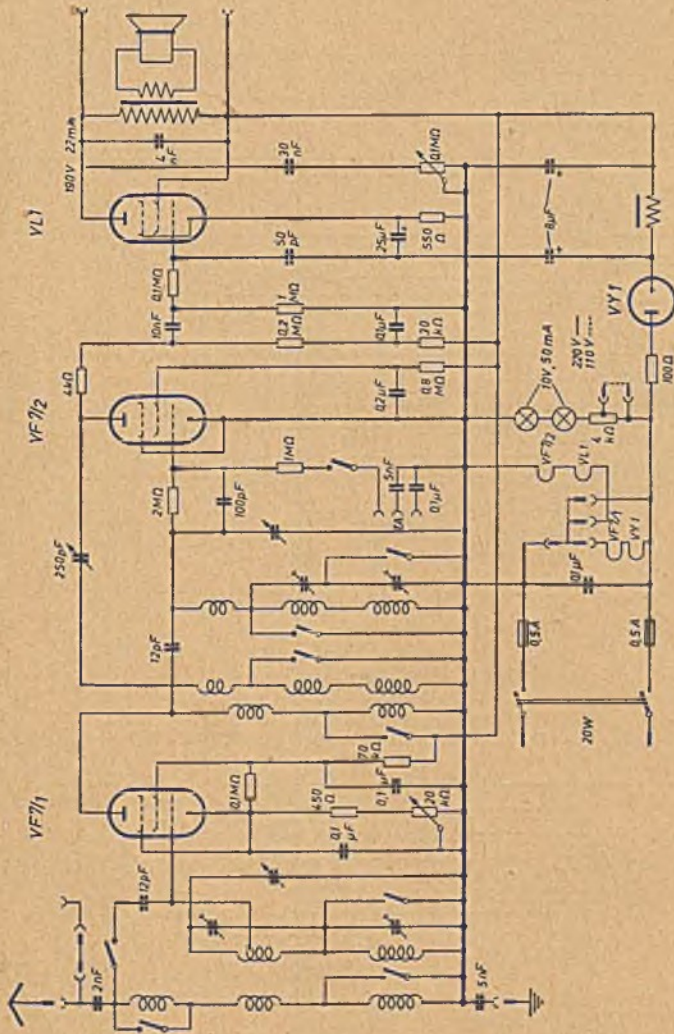

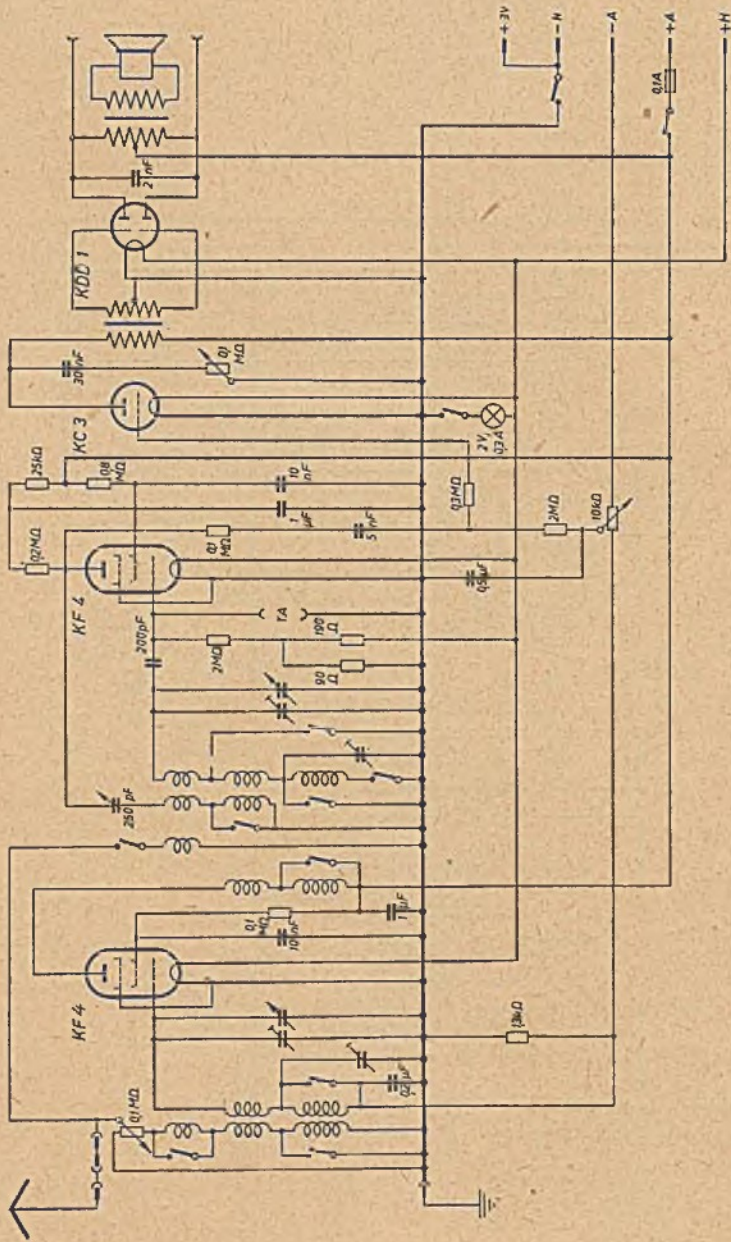

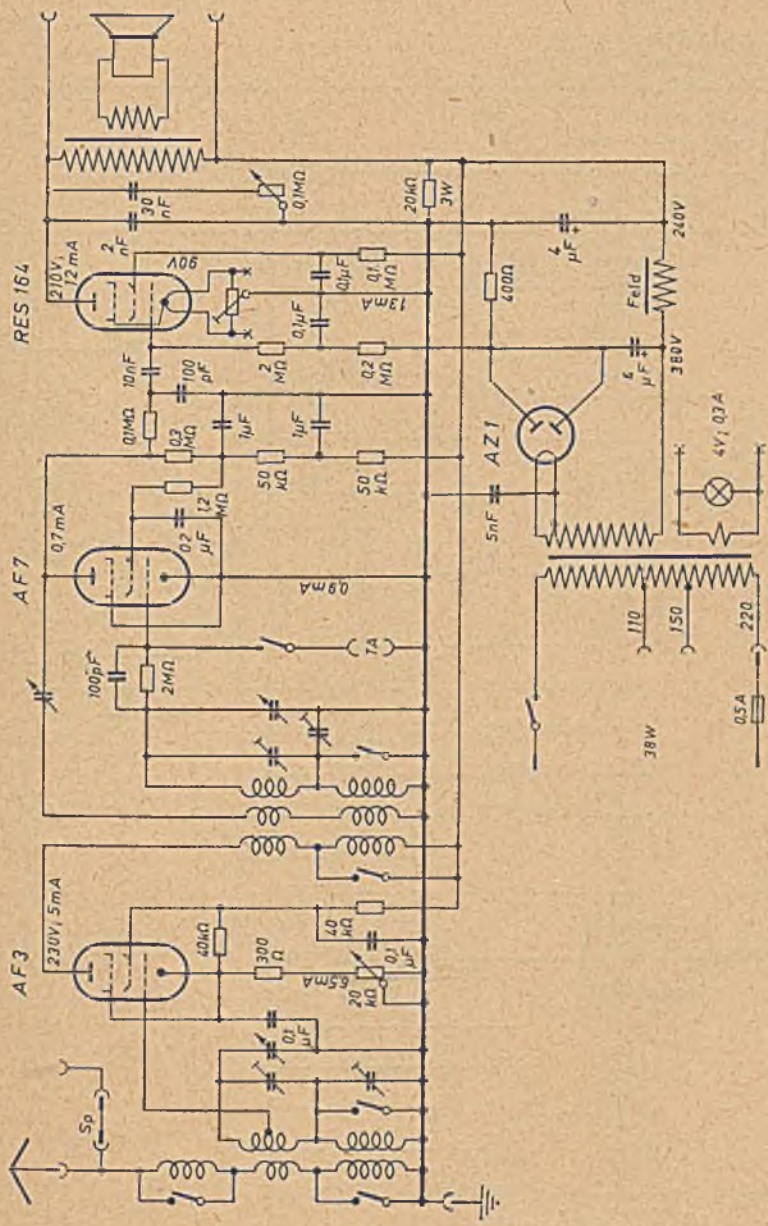



BRAUN
(Produktion nach 1945)



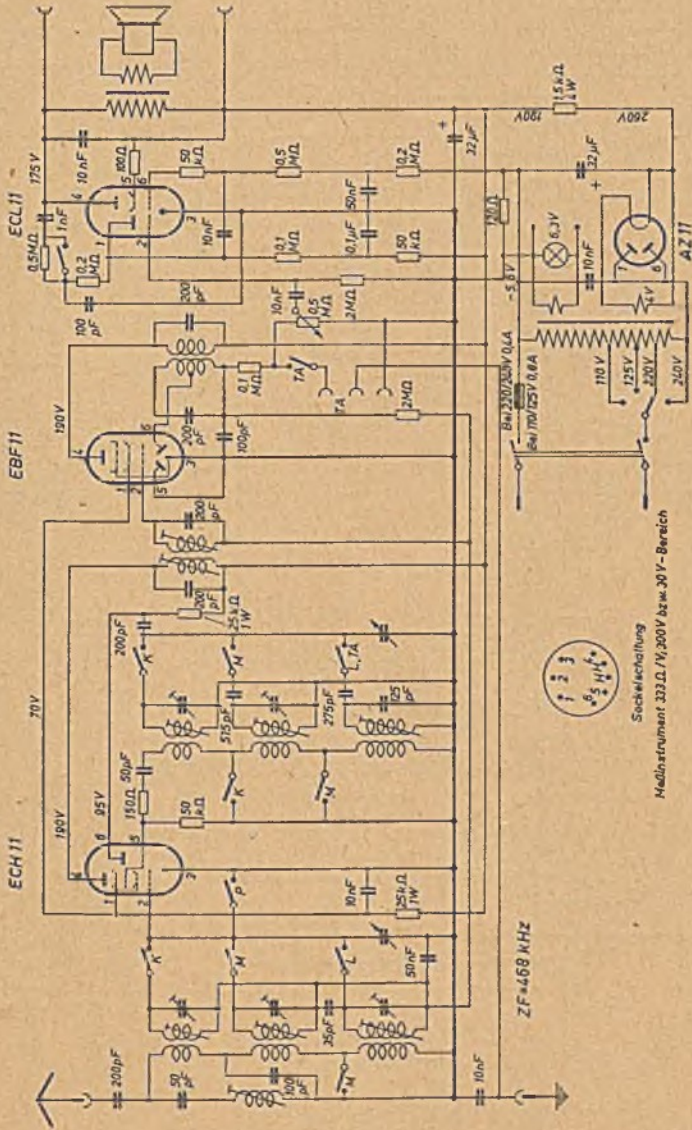

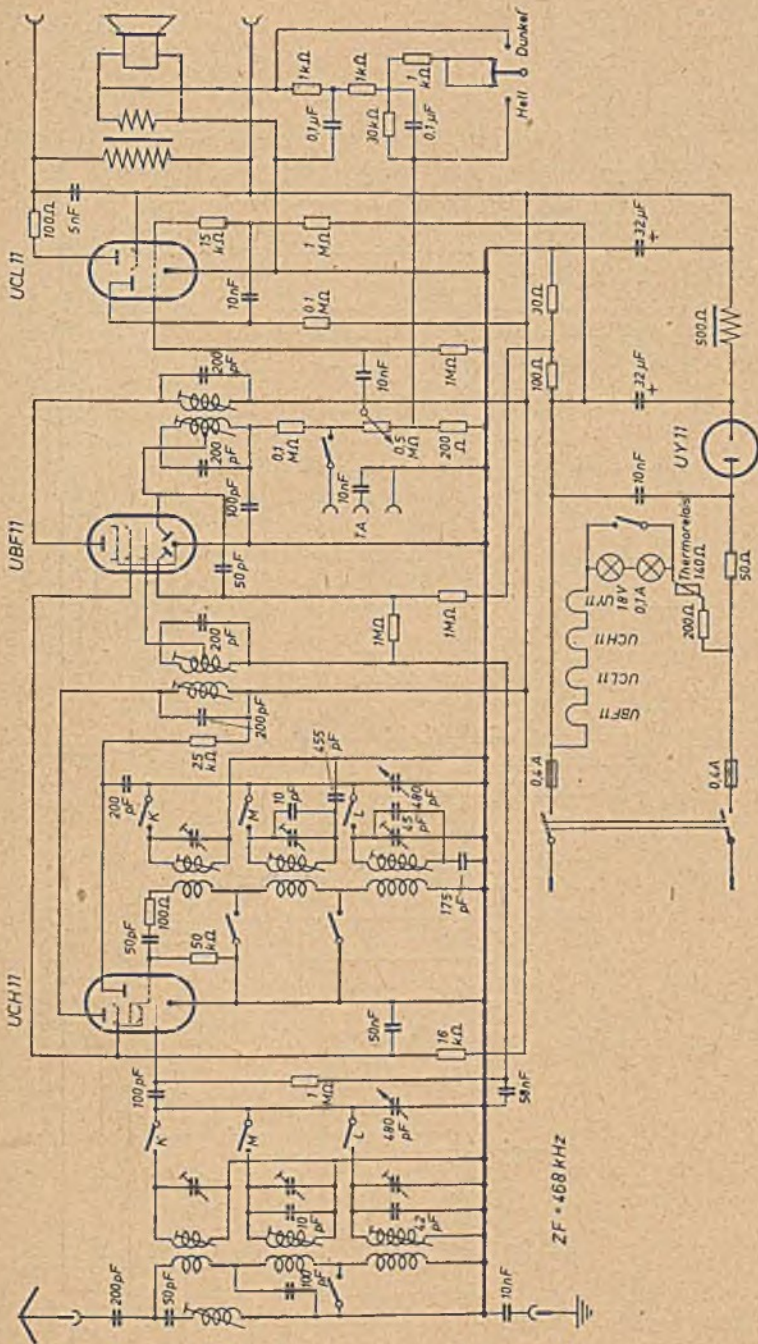

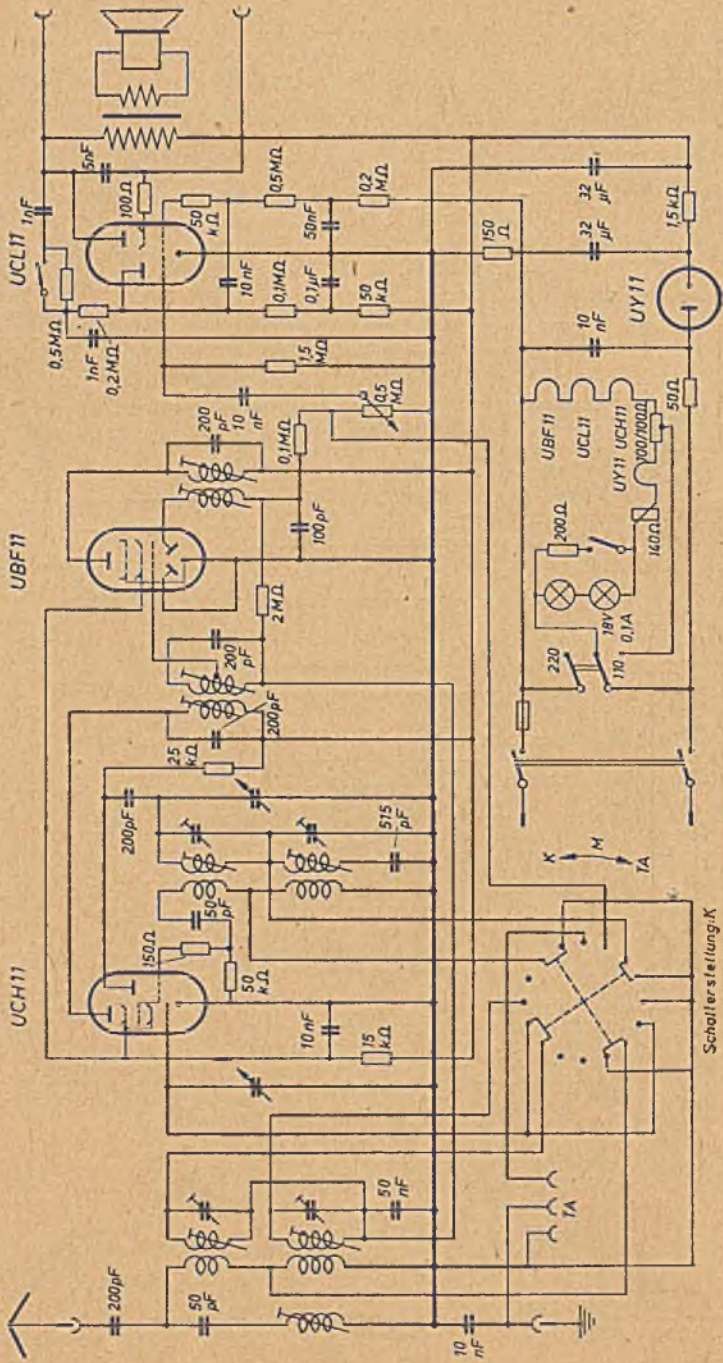

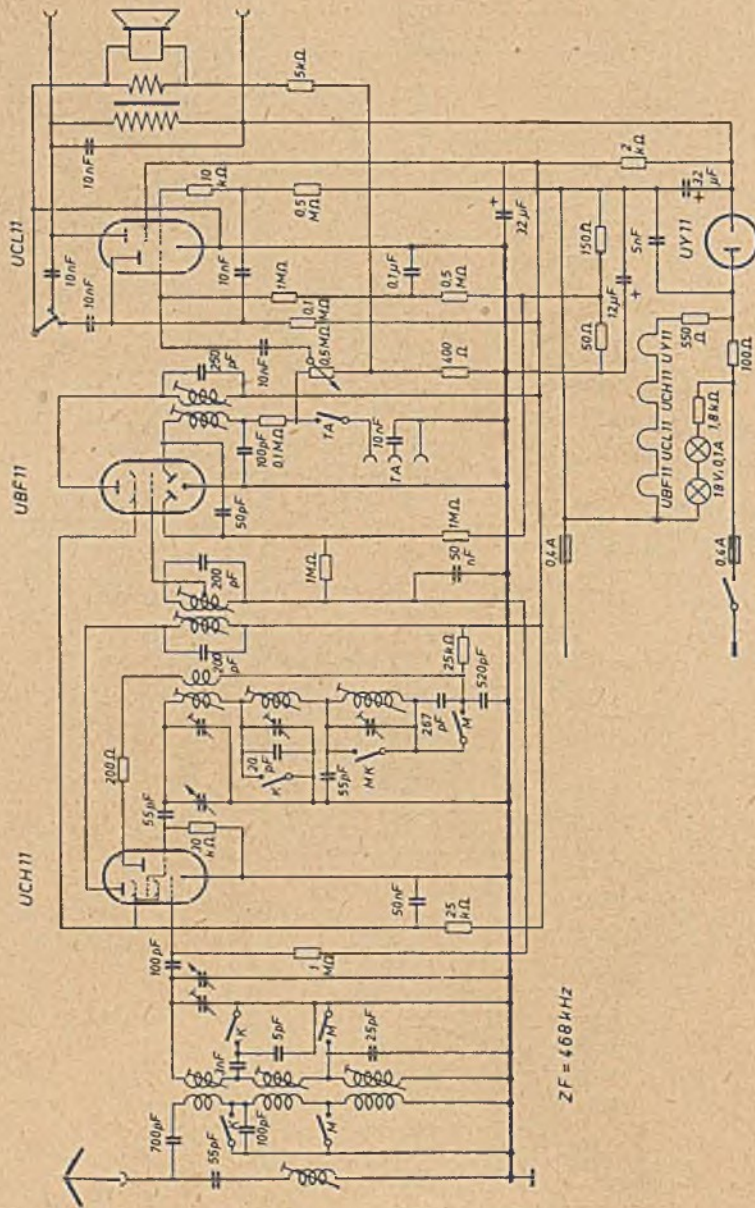

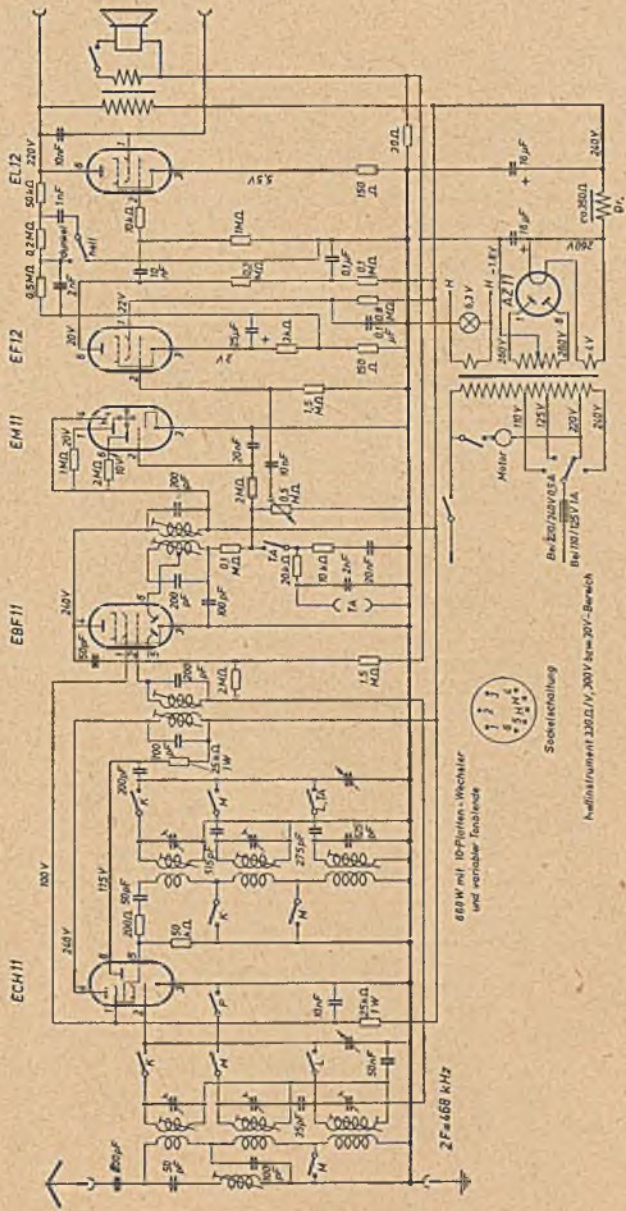

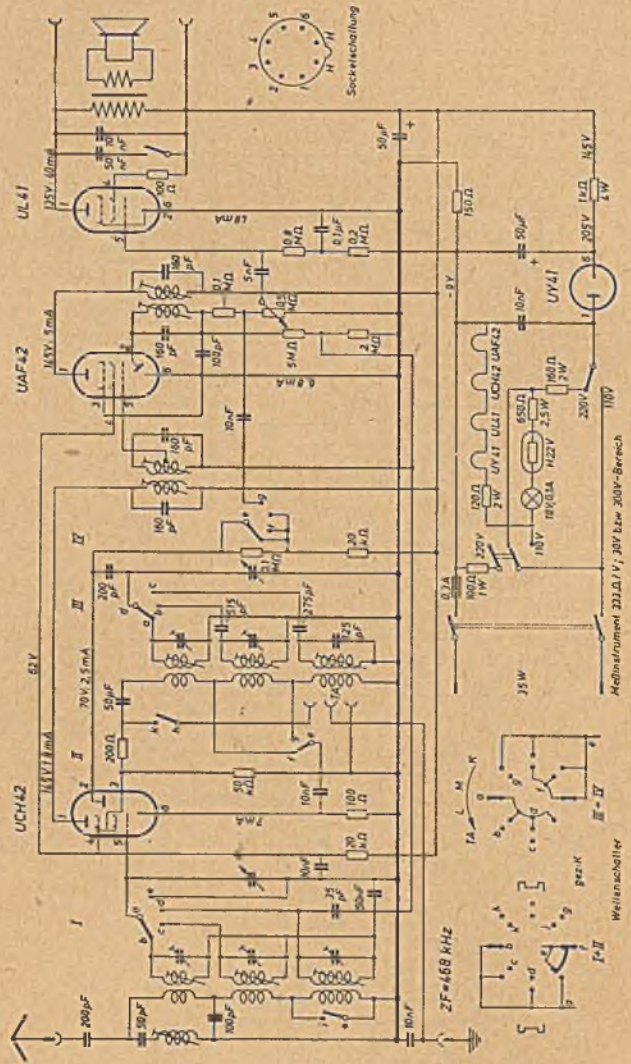

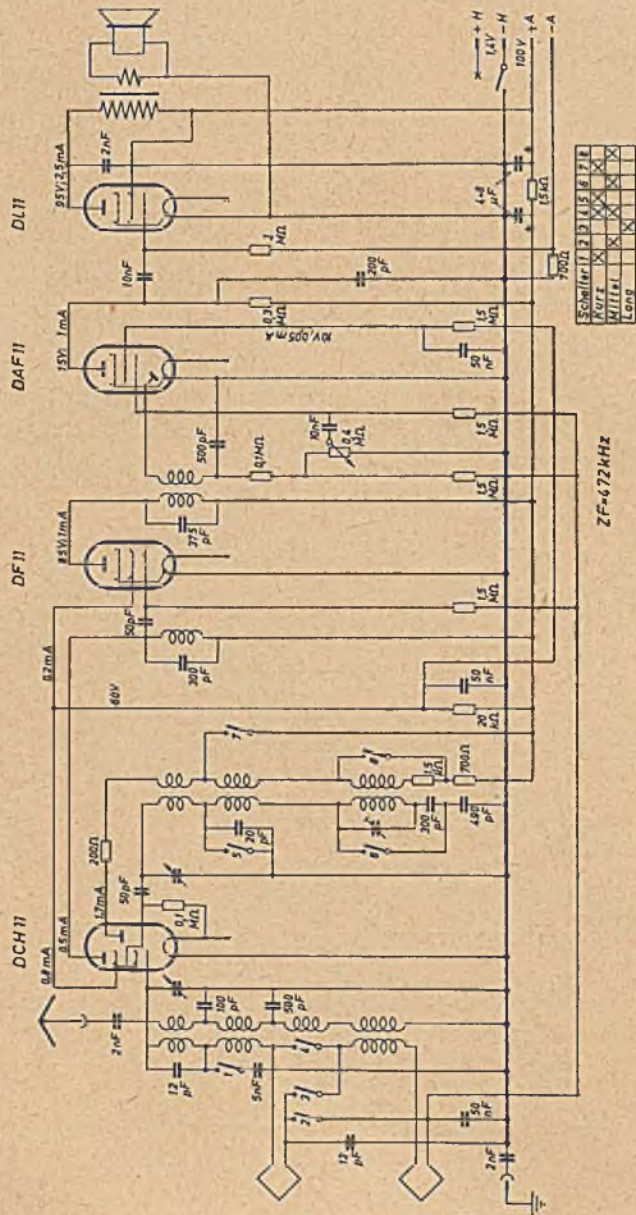

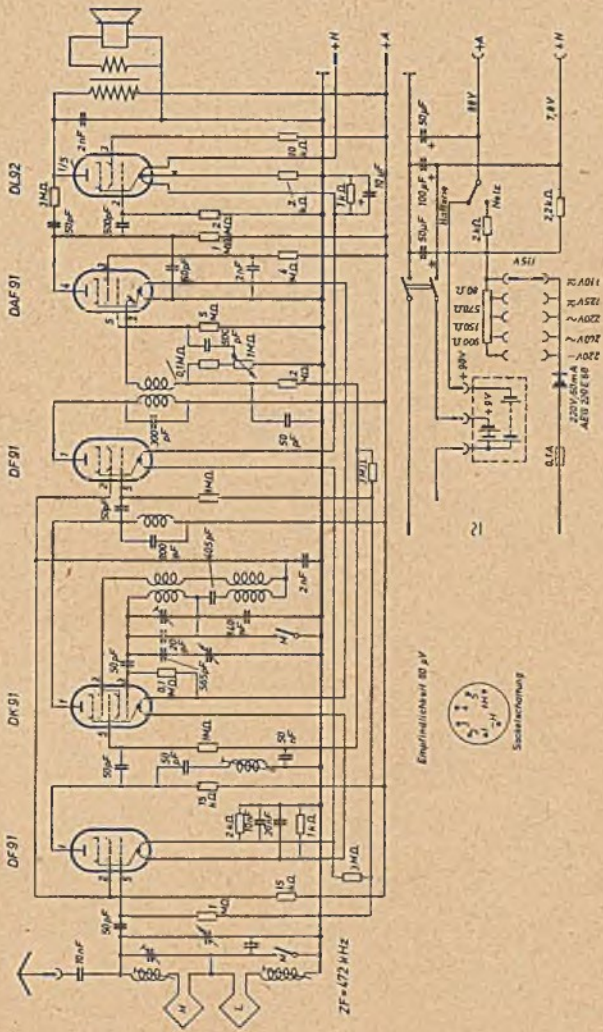

Empfindlichkeit 80 μV





BRAUN
(Produktion vor 1945)



Braun Kobold 3 Röhren

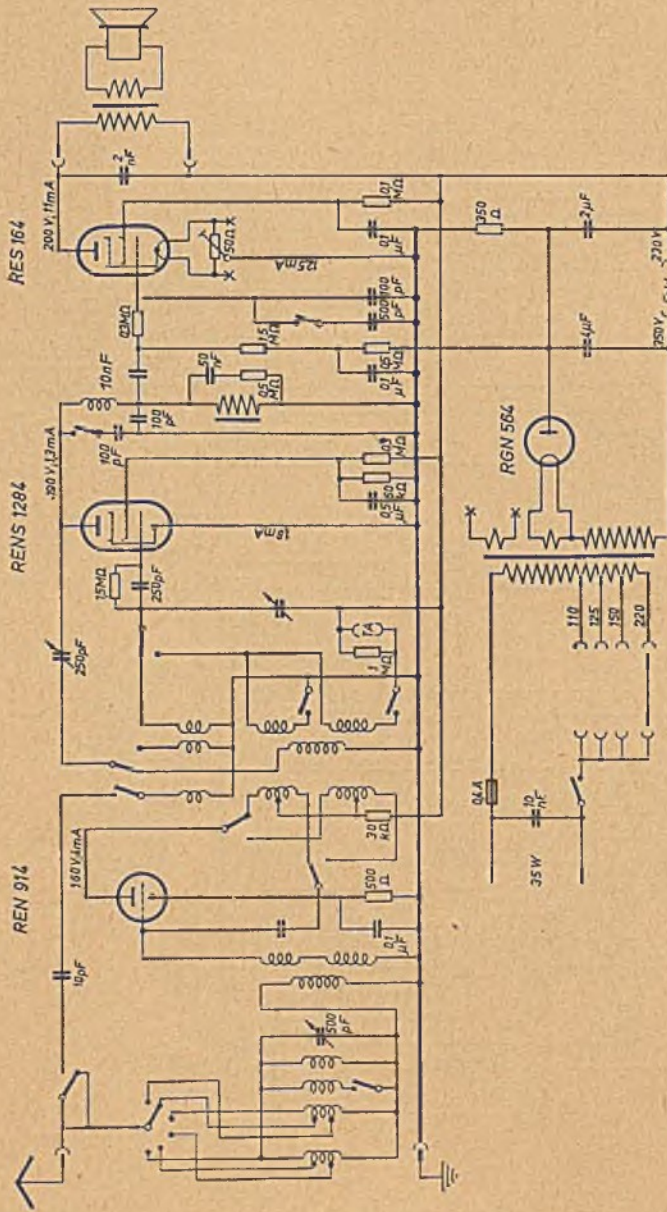

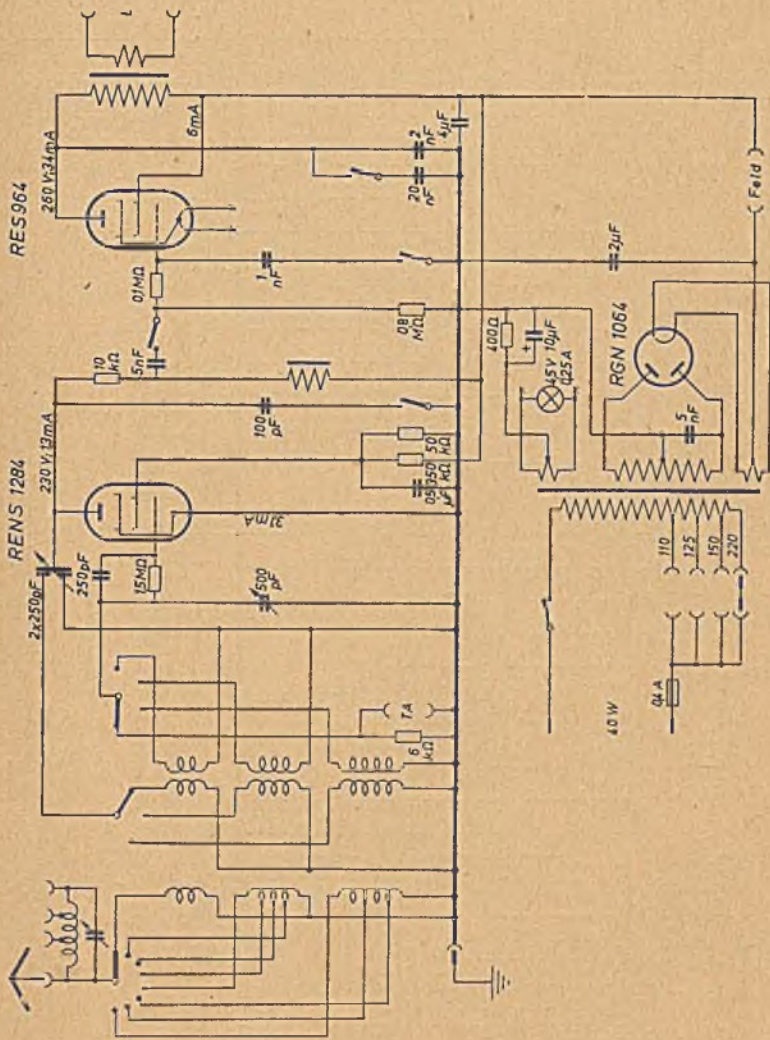

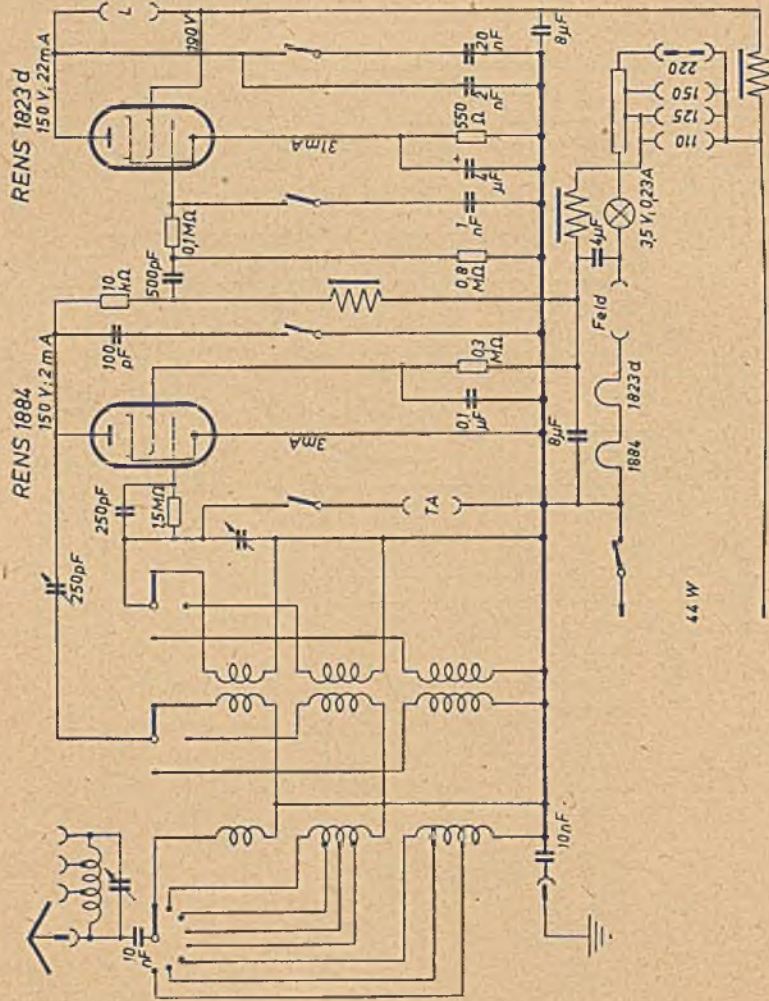

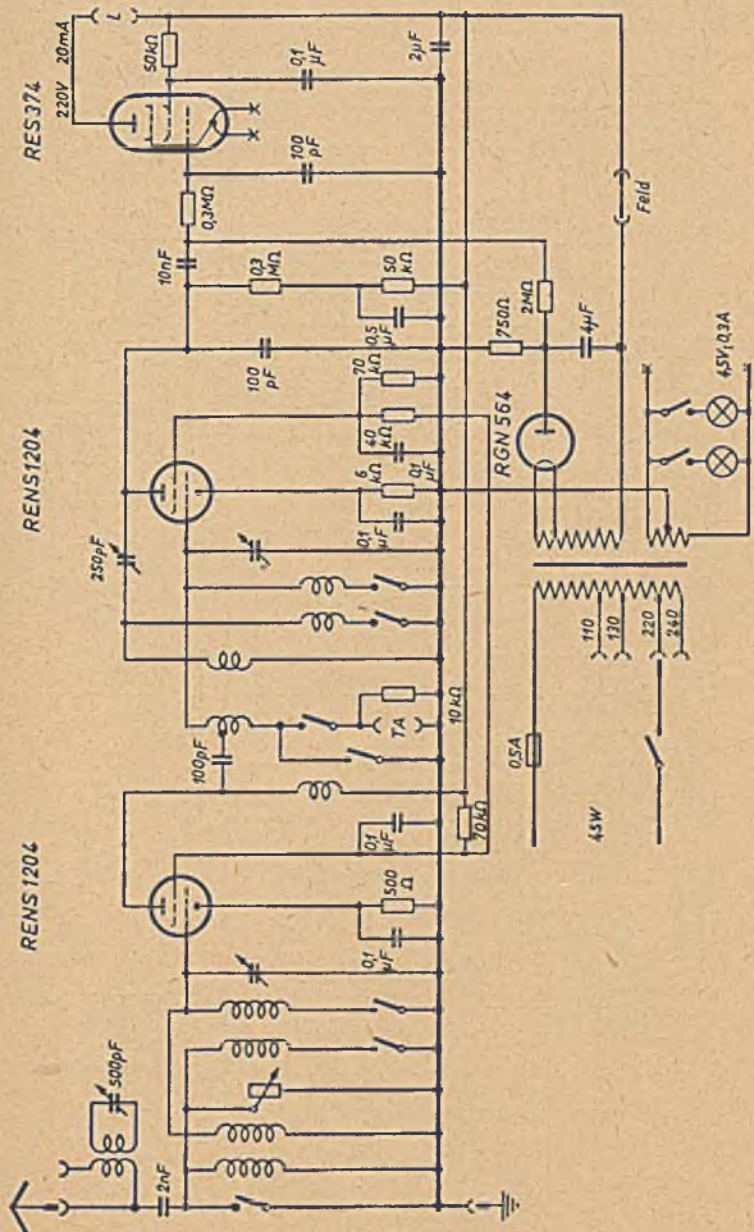

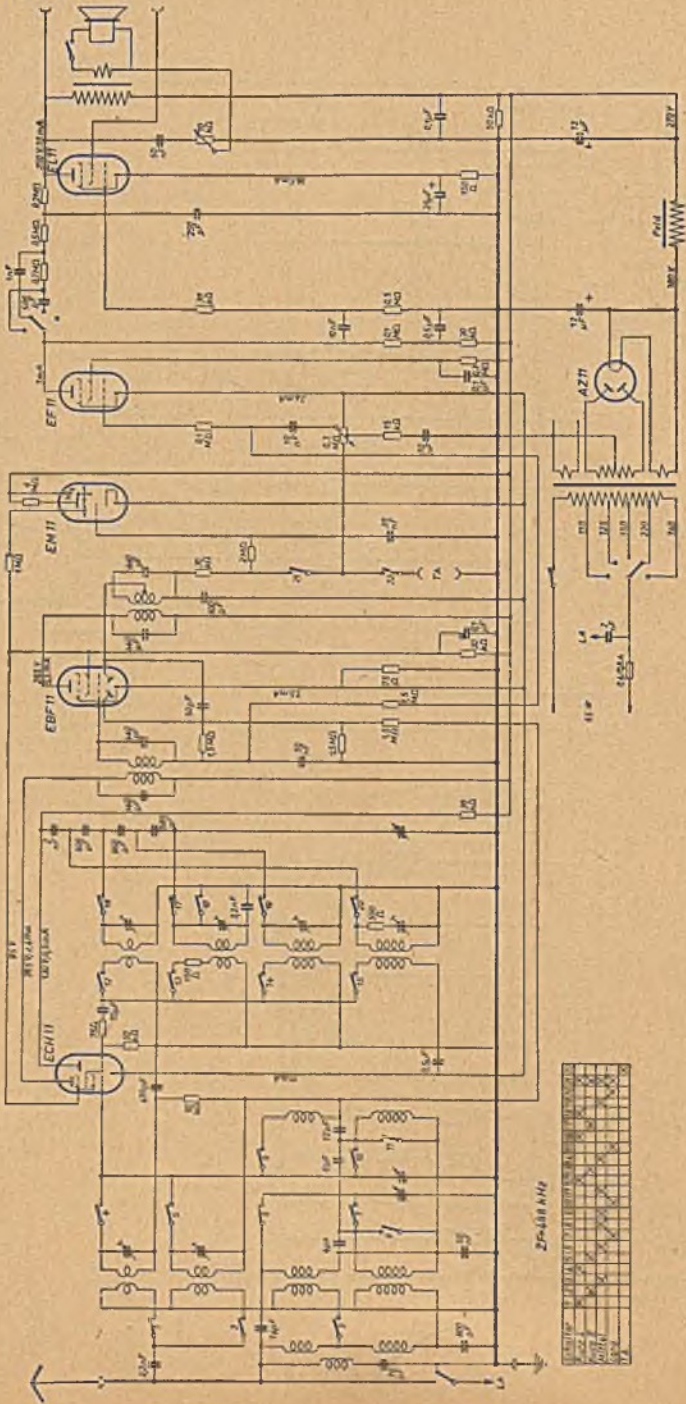

Zf-130 kHz

Bandwidth	Attenuation	Gain	Phase Shift	Impedance
0.1 Hz	0 dB	1	0°	100 Ω
0.2 Hz	0 dB	1	0°	100 Ω
0.5 Hz	0 dB	1	0°	100 Ω
1 Hz	0 dB	1	0°	100 Ω
2 Hz	0 dB	1	0°	100 Ω
5 Hz	0 dB	1	0°	100 Ω
10 Hz	0 dB	1	0°	100 Ω
20 Hz	0 dB	1	0°	100 Ω
50 Hz	0 dB	1	0°	100 Ω
100 Hz	0 dB	1	0°	100 Ω
200 Hz	0 dB	1	0°	100 Ω
500 Hz	0 dB	1	0°	100 Ω
1 kHz	0 dB	1	0°	100 Ω
2 kHz	0 dB	1	0°	100 Ω
5 kHz	0 dB	1	0°	100 Ω
10 kHz	0 dB	1	0°	100 Ω
20 kHz	0 dB	1	0°	100 Ω
50 kHz	0 dB	1	0°	100 Ω
100 kHz	0 dB	1	0°	100 Ω
200 kHz	0 dB	1	0°	100 Ω
500 kHz	0 dB	1	0°	100 Ω
1 MHz	0 dB	1	0°	100 Ω

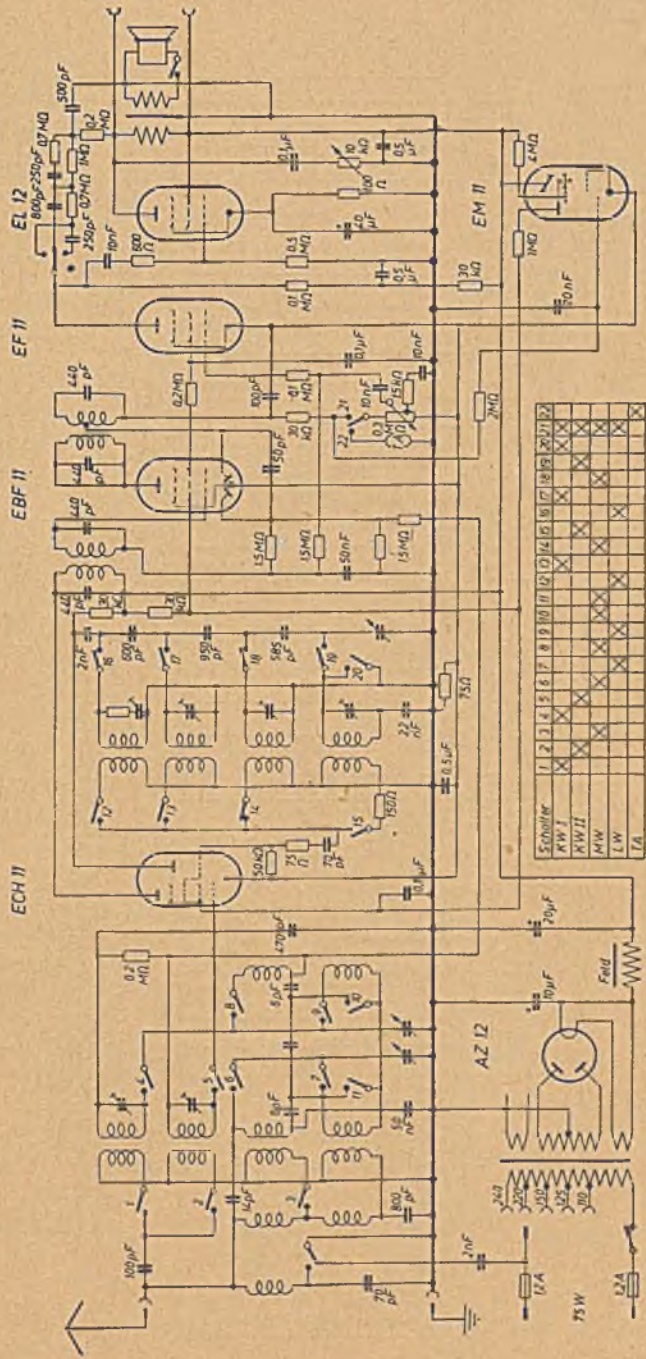

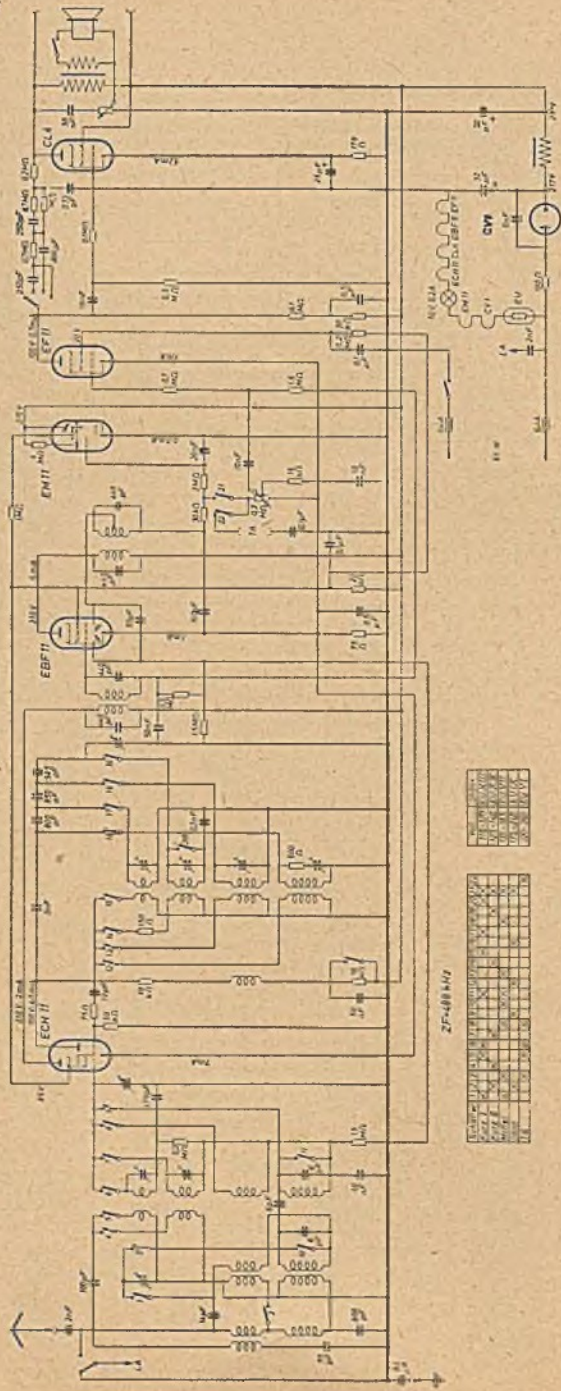

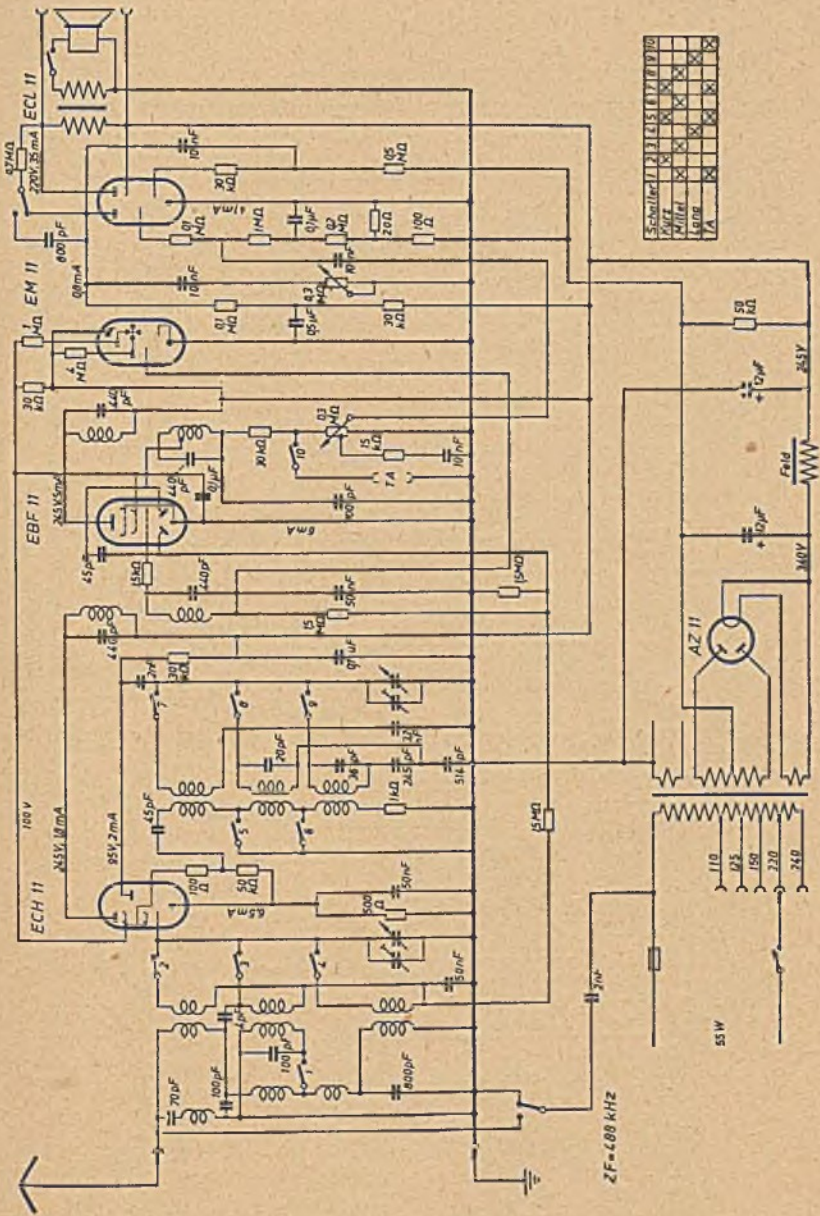

Schaltung	1	2	3	4	5	6	7	8	9	10
50V										
100V										
250V										
500V										
1000V										

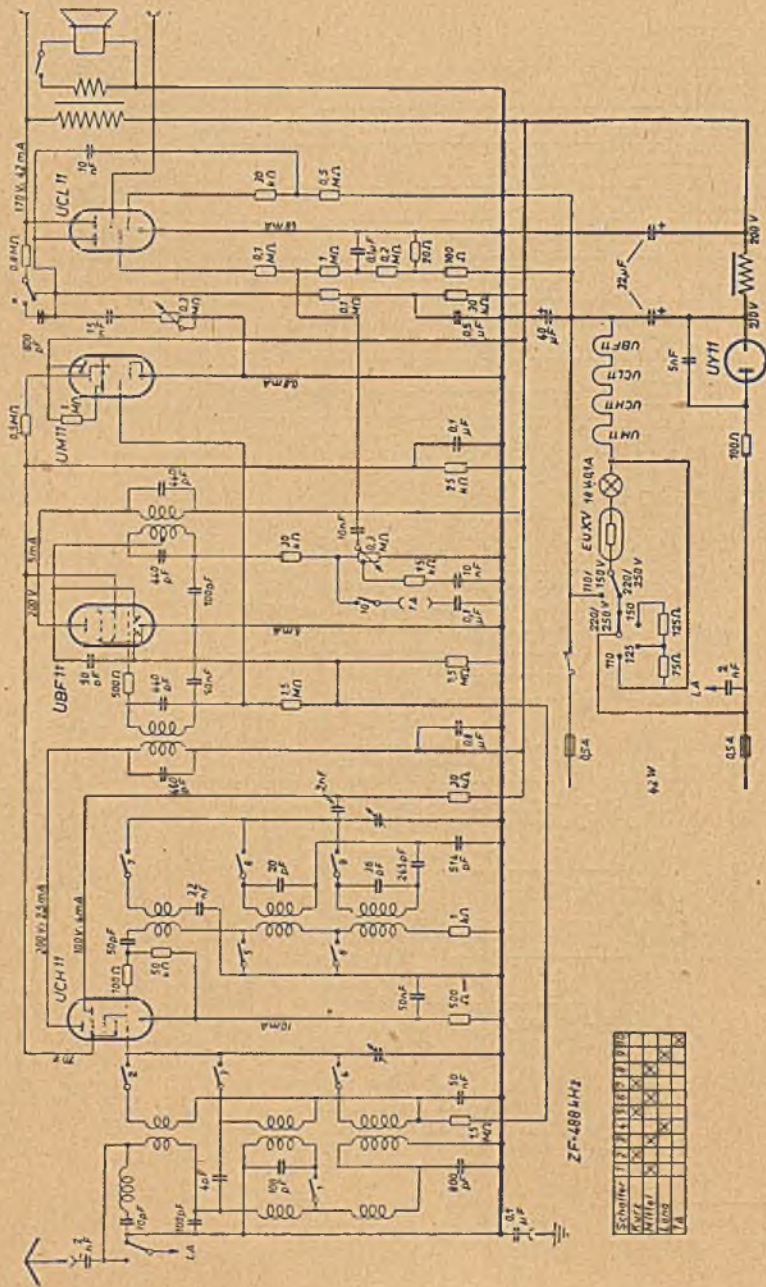

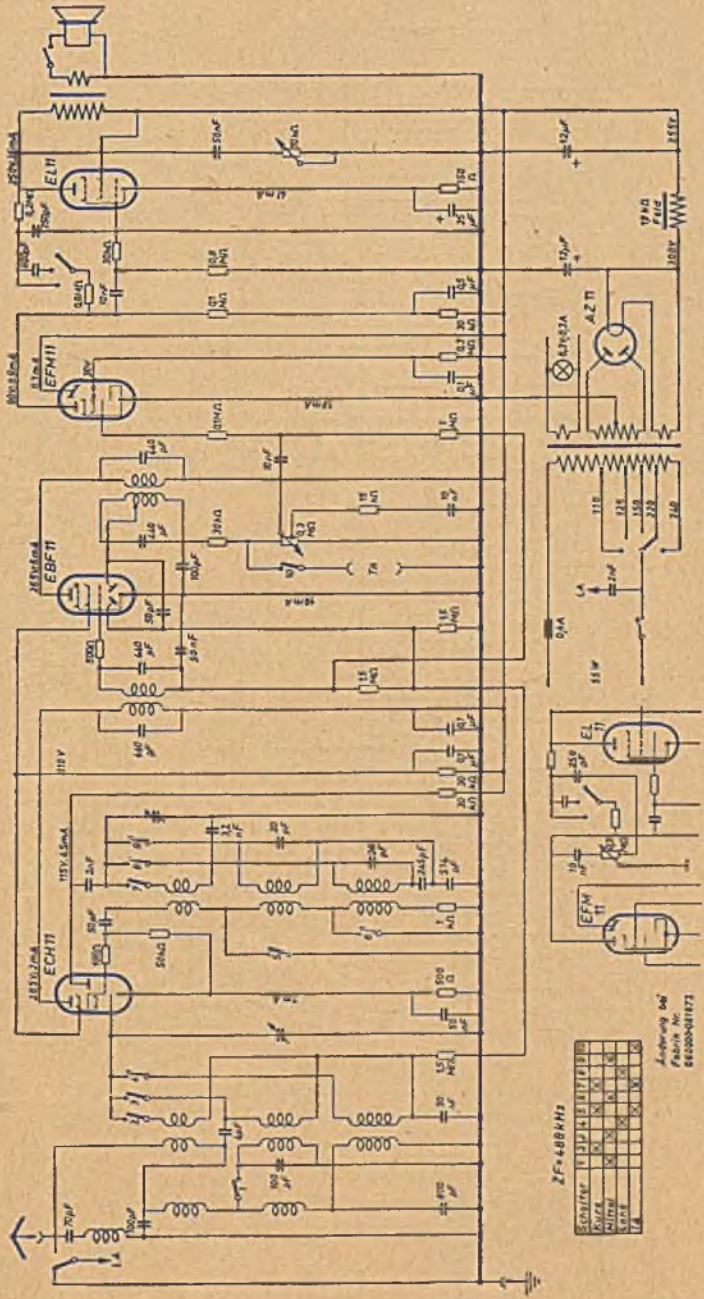

ZF = 488 kHz

COND	1	2	3	4	5	6	7	8	9	10	11	12	13	14	15	16	17	18	19	20
120V	1	1	1	1	1	1	1	1	1	1	1	1	1	1	1	1	1	1	1	1
120V	1	1	1	1	1	1	1	1	1	1	1	1	1	1	1	1	1	1	1	1
120V	1	1	1	1	1	1	1	1	1	1	1	1	1	1	1	1	1	1	1	1
120V	1	1	1	1	1	1	1	1	1	1	1	1	1	1	1	1	1	1	1	1
120V	1	1	1	1	1	1	1	1	1	1	1	1	1	1	1	1	1	1	1	1
120V	1	1	1	1	1	1	1	1	1	1	1	1	1	1	1	1	1	1	1	1
120V	1	1	1	1	1	1	1	1	1	1	1	1	1	1	1	1	1	1	1	1
120V	1	1	1	1	1	1	1	1	1	1	1	1	1	1	1	1	1	1	1	1
120V	1	1	1	1	1	1	1	1	1	1	1	1	1	1	1	1	1	1	1	1
120V	1	1	1	1	1	1	1	1	1	1	1	1	1	1	1	1	1	1	1	1
120V	1	1	1	1	1	1	1	1	1	1	1	1	1	1	1	1	1	1	1	1
120V	1	1	1	1	1	1	1	1	1	1	1	1	1	1	1	1	1	1	1	1
120V	1	1	1	1	1	1	1	1	1	1	1	1	1	1	1	1	1	1	1	1
120V	1	1	1	1	1	1	1	1	1	1	1	1	1	1	1	1	1	1	1	1
120V	1	1	1	1	1	1	1	1	1	1	1	1	1	1	1	1	1	1	1	1
120V	1	1	1	1	1	1	1	1	1	1	1	1	1	1	1	1	1	1	1	1
120V	1	1	1	1	1	1	1	1	1	1	1	1	1	1	1	1	1	1	1	1
120V	1	1	1	1	1	1	1	1	1	1	1	1	1	1	1	1	1	1	1	1
120V	1	1	1	1	1	1	1	1	1	1	1	1	1	1	1	1	1	1	1	1
120V	1	1	1	1	1	1	1	1	1	1	1	1	1	1	1	1	1	1	1	1
120V	1	1	1	1	1	1	1	1	1	1	1	1	1	1	1	1	1	1	1	1

Assembled by
Pabrik No
64400001877

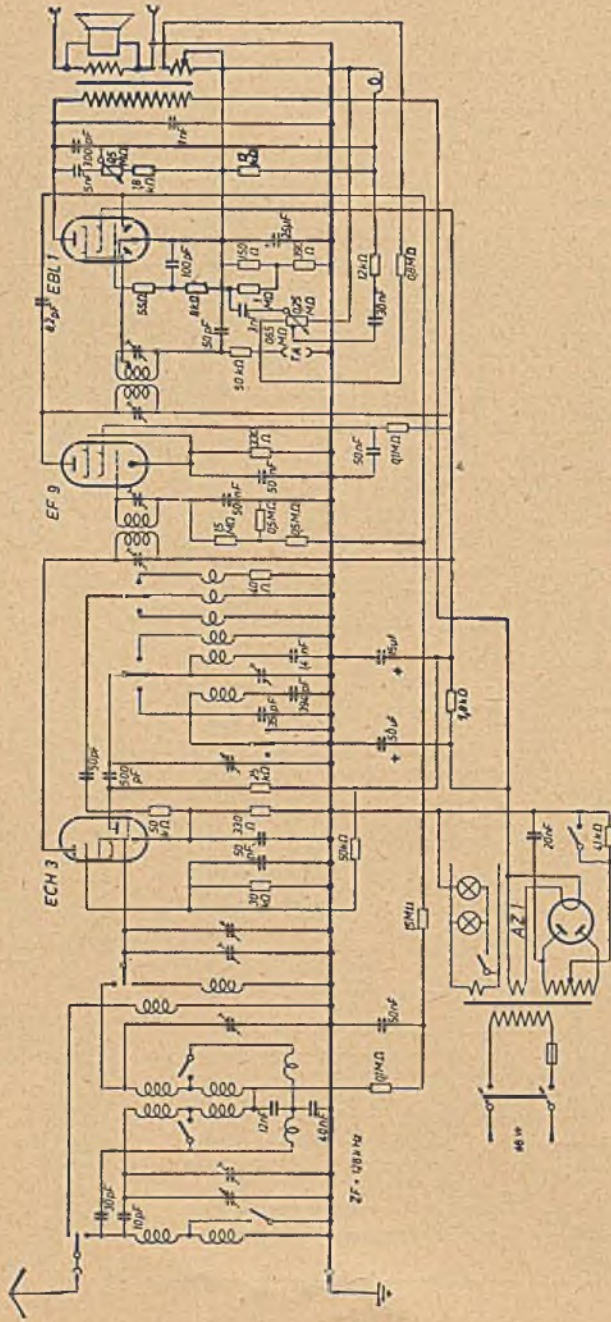

Trimmer der Hochfrequenzkreise 20 pF
 Trimmer der Zwischenfrequenzkreise 70—100 pF
 Drehkondensator je 11—490 pF

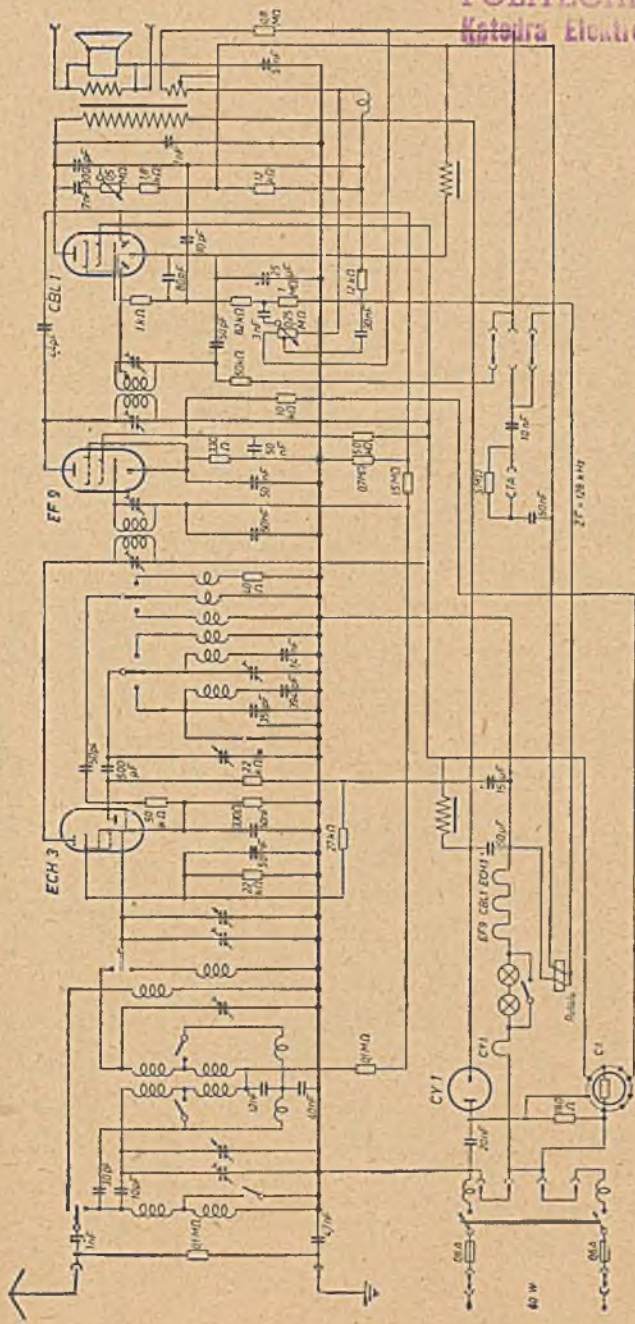

Trimmer der Hochfrequenzkreise 20 pF
Trimmer der Zwischenfrequenzkreise 70—100 pF
Drehkondensator je 11—480 pF

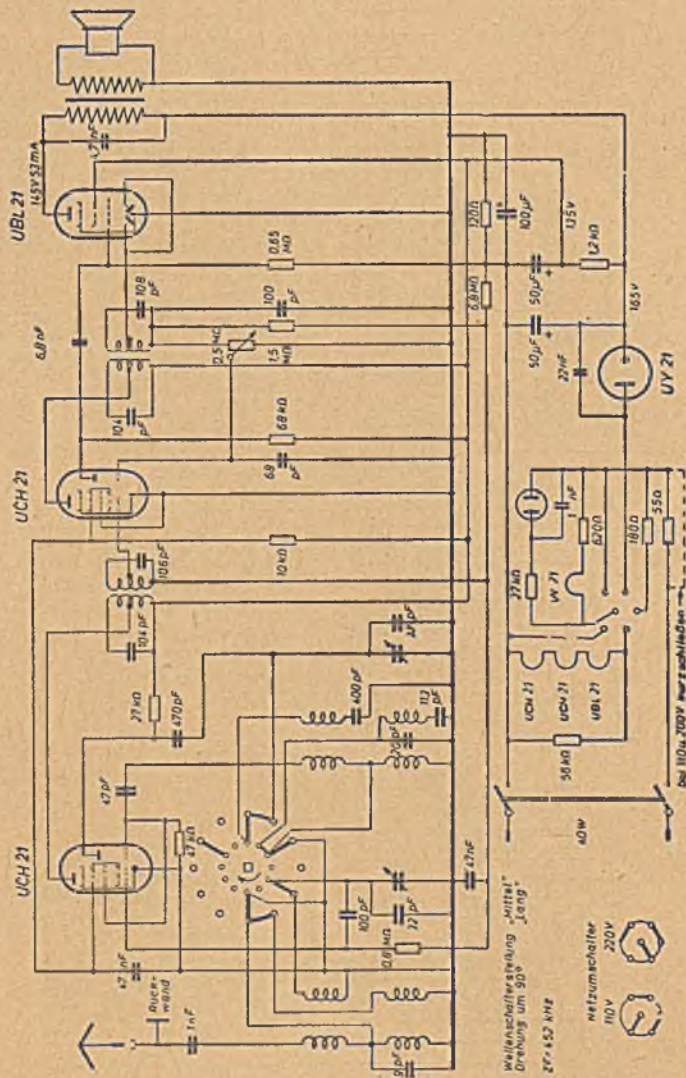

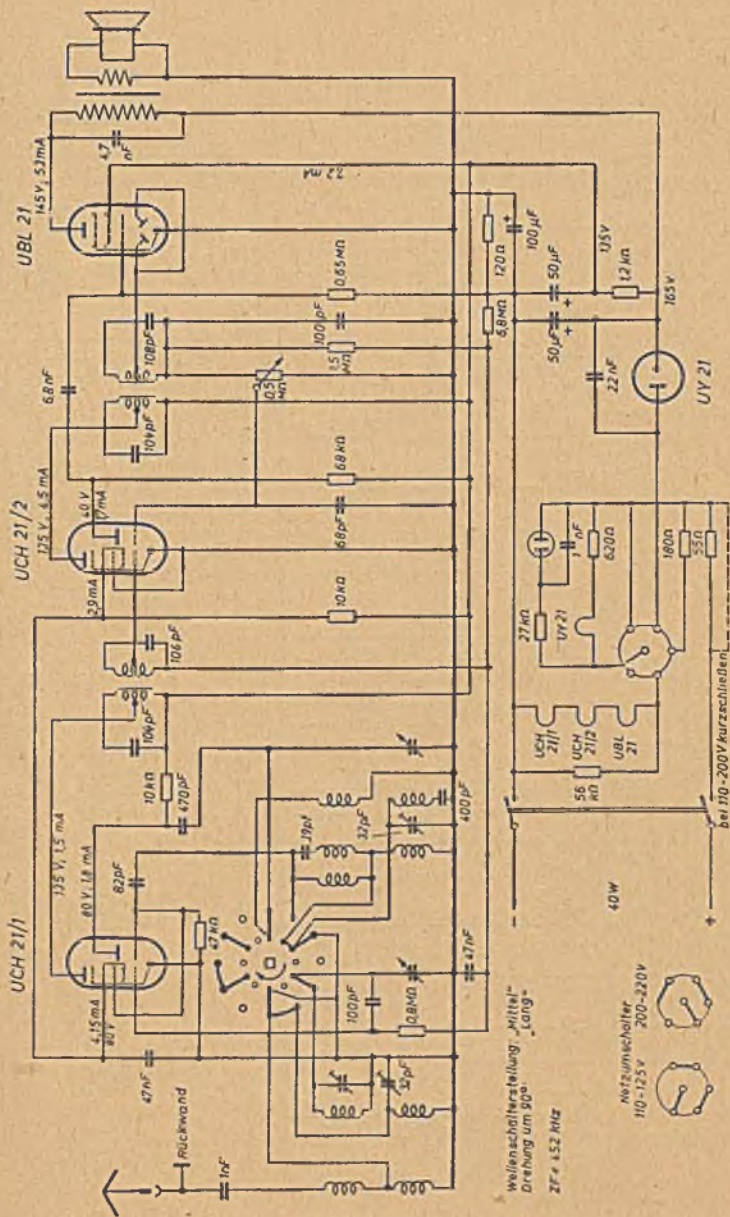

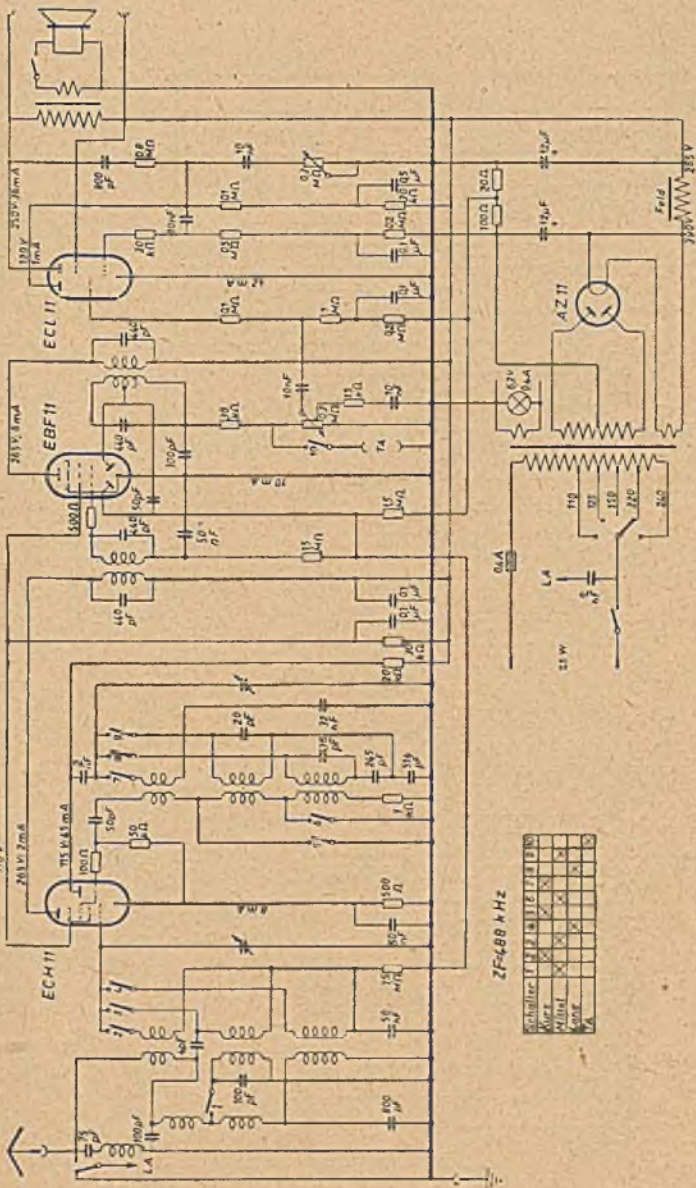

ZF=489 kHz

Schaltung	1	2	3	4	5	6	7	8	9	10	11	12
Werte												
Werte												
Werte												
Werte												

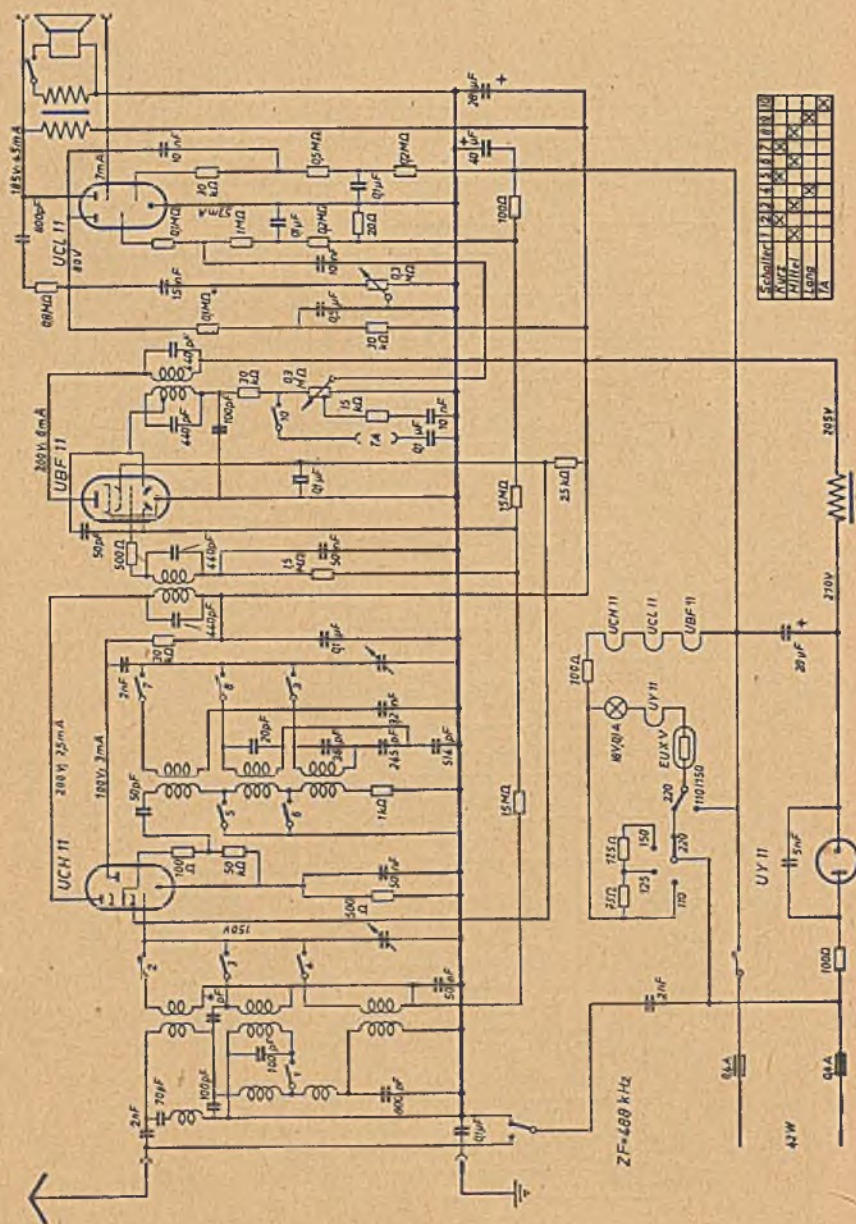

Schaltplan	1	2	3	4	5	6	7	8	9	10
Kurzsch.										
Offiziell										
Lebend										
TA										

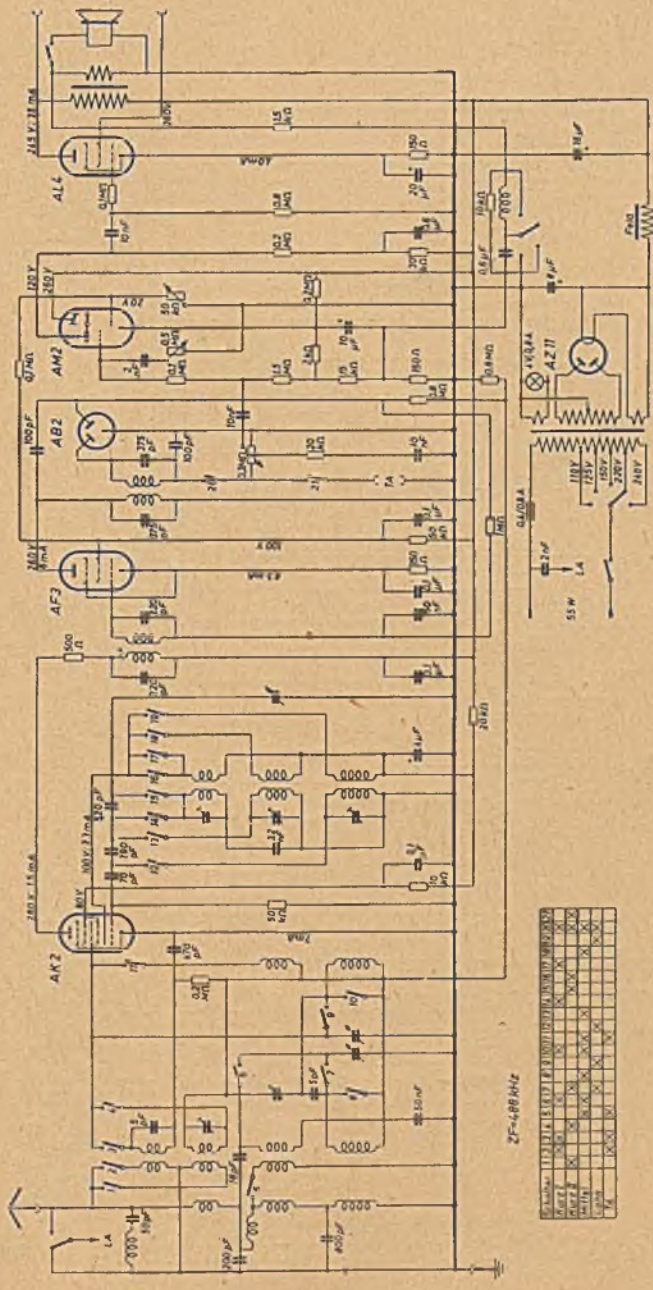

2F-468 kHz

Plate	1	2	3	4	5	6	7	8	9	10	11	12	13	14	15	16	17	18	19	20	21	22	23	24	25	26	27	28	29	30	31	32	33	34	35	36	37	38	39	40	41	42	43	44	45	46	47	48	49	50
1	2	3	4	5	6	7	8	9	10	11	12	13	14	15	16	17	18	19	20	21	22	23	24	25	26	27	28	29	30	31	32	33	34	35	36	37	38	39	40	41	42	43	44	45	46	47	48	49	50	

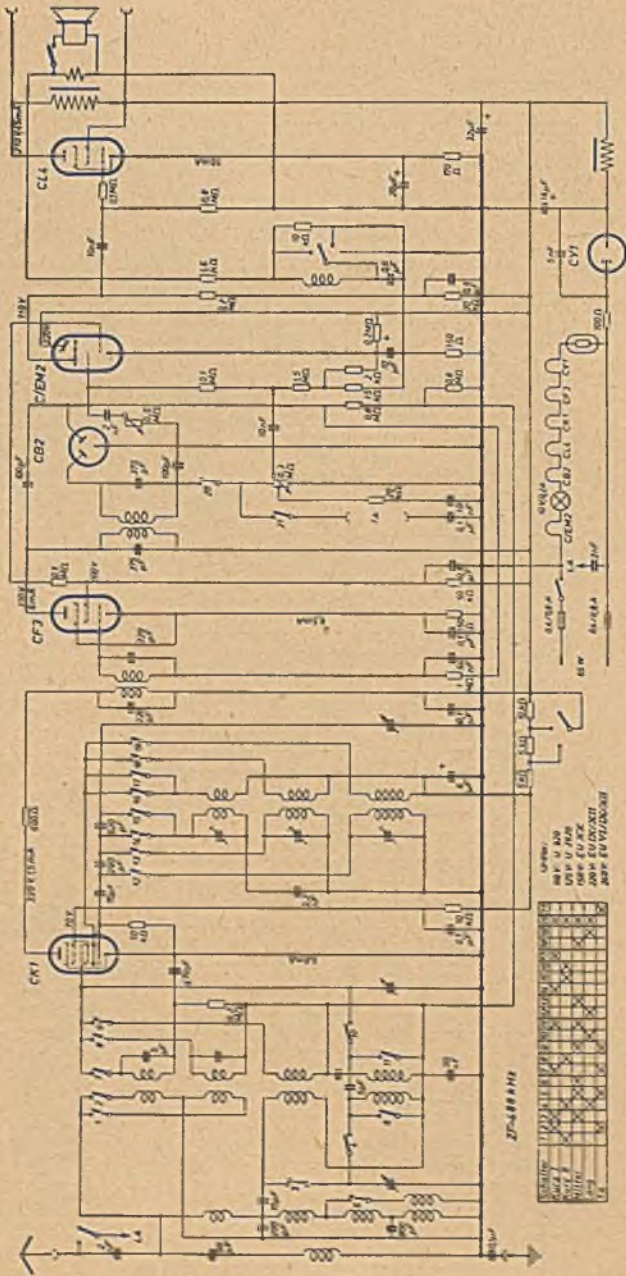

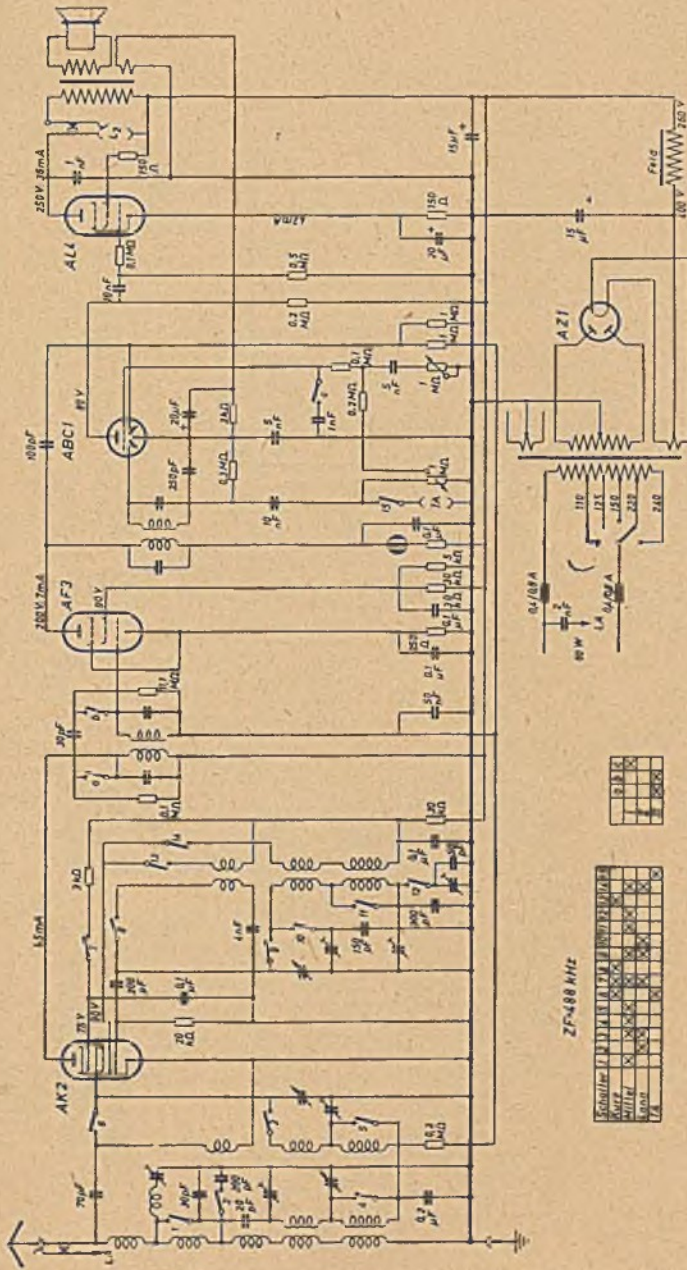

1	2	3	4	5	6	7	8	9	10
11	12	13	14	15	16	17	18	19	20
21	22	23	24	25	26	27	28	29	30
31	32	33	34	35	36	37	38	39	40

ZF-488 kHz

1	2	3	4	5	6	7	8	9	10
11	12	13	14	15	16	17	18	19	20
21	22	23	24	25	26	27	28	29	30
31	32	33	34	35	36	37	38	39	40
41	42	43	44	45	46	47	48	49	50

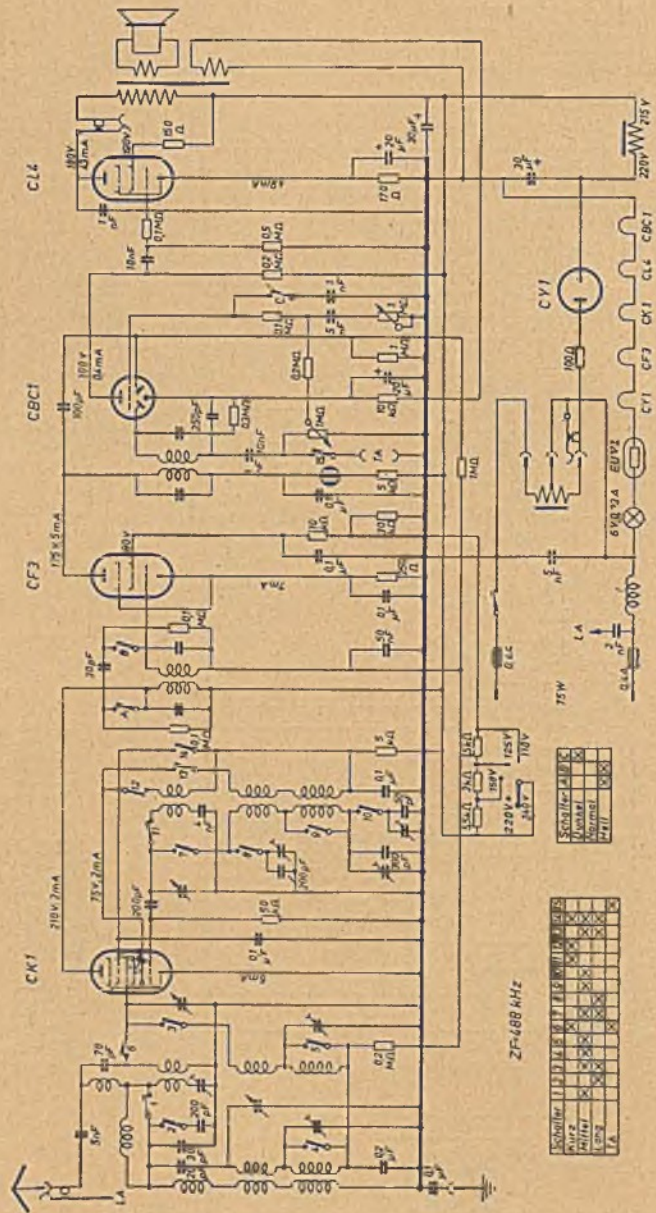

500k	200k	100k	50k	10k	1k	100Ω	10Ω	1Ω
100pF	10nF	1μF	20μF	100μF	1mF	10mF	100mF	1F

Schalter	1	2	3	4	5	6	7	8	9	10
Antenn	X	X	X	X	X	X	X	X	X	X
Antenn	X	X	X	X	X	X	X	X	X	X
Antenn	X	X	X	X	X	X	X	X	X	X
L.A.	X	X	X	X	X	X	X	X	X	X

ZF-488 kHz

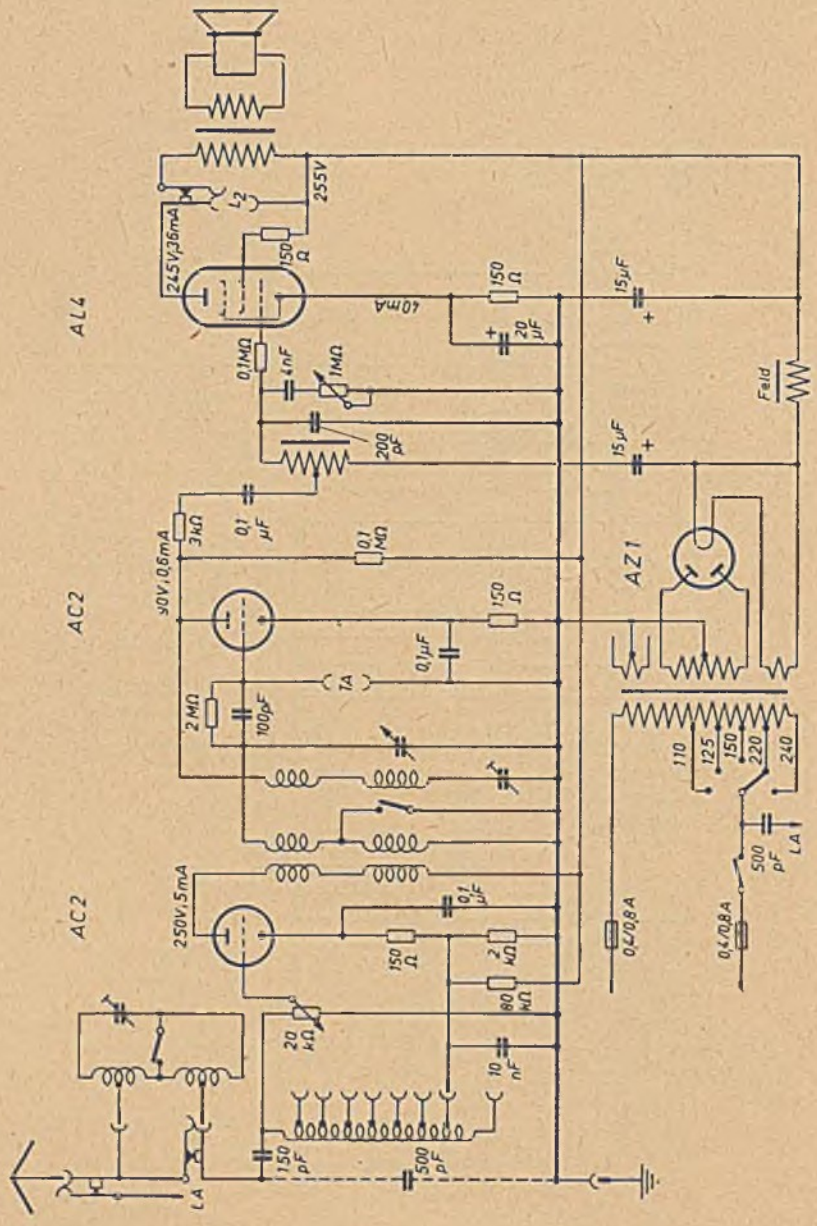

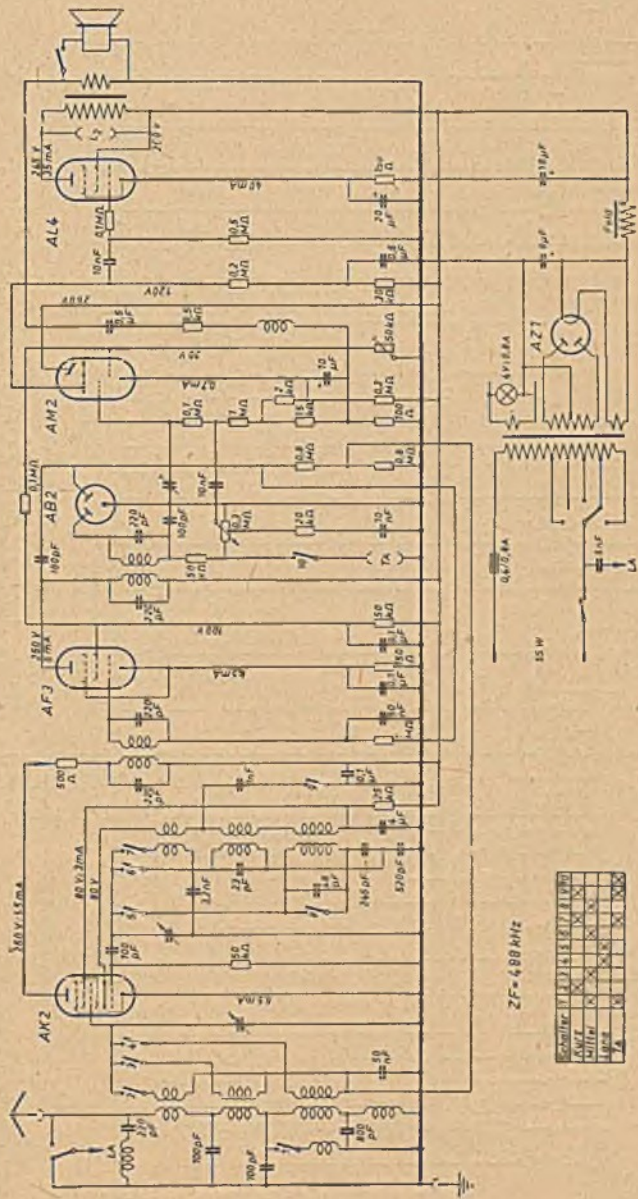

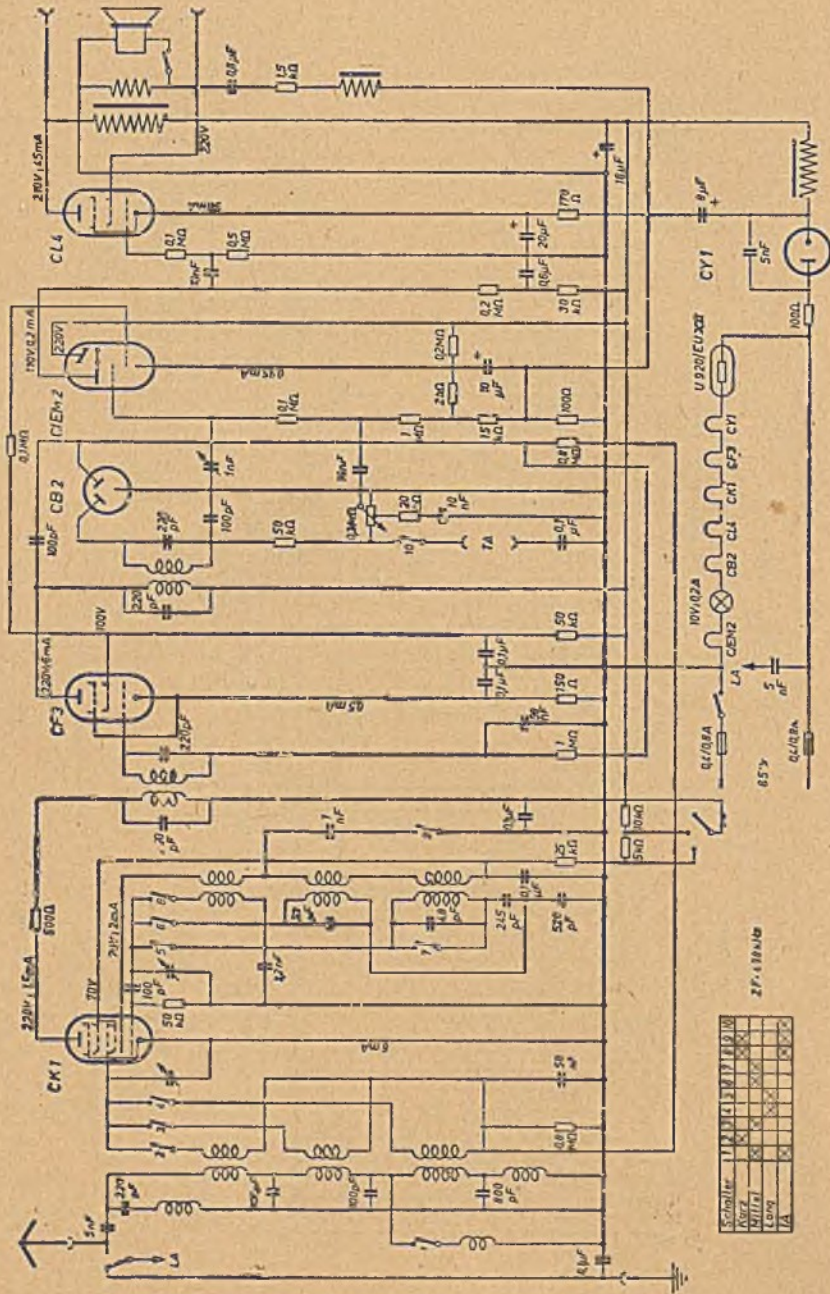

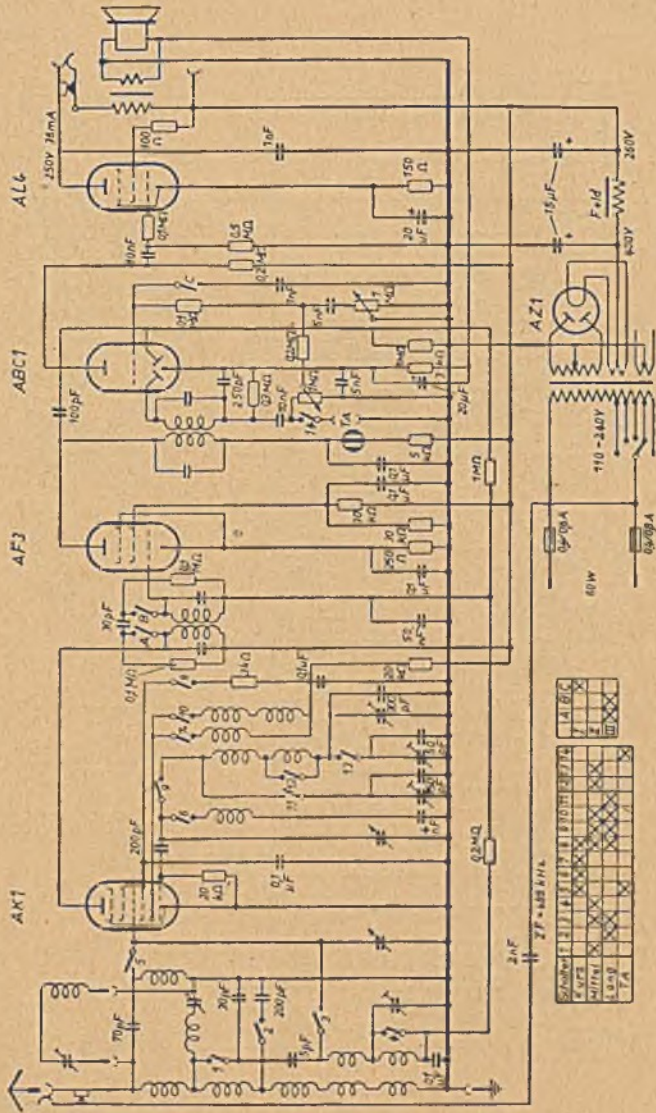

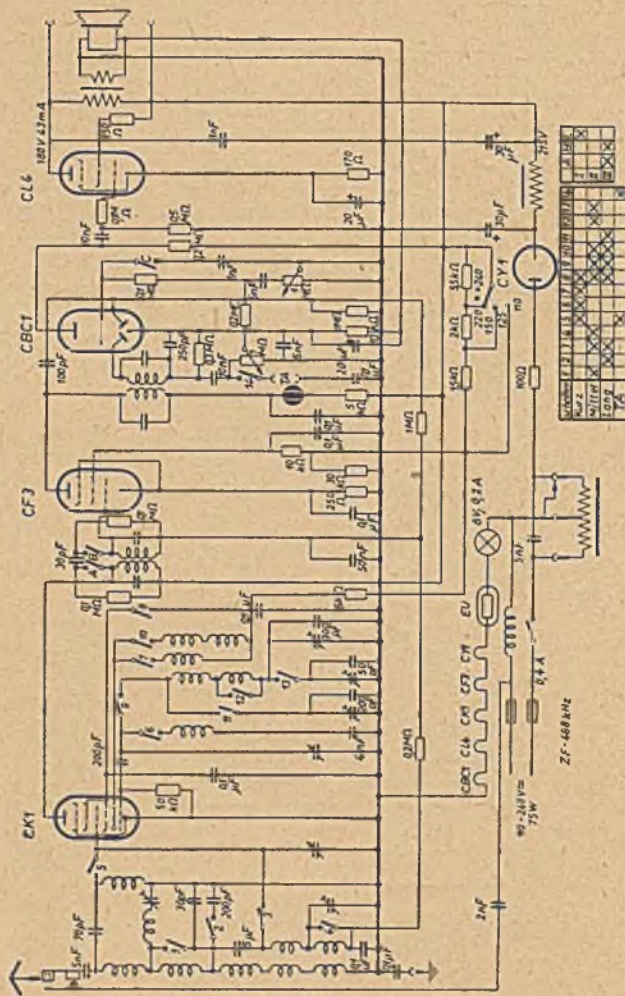

- Braun **Trumpf-Junior 555 GL** (Bakelit-Gehäuse)
 " " **565 GL** (Holz-Gehäuse, braun)
 " " **575 GL** (555 GL und Phono)
 " " **585 GL** (555 GL Holz-Gehäuse,
 schwarz)

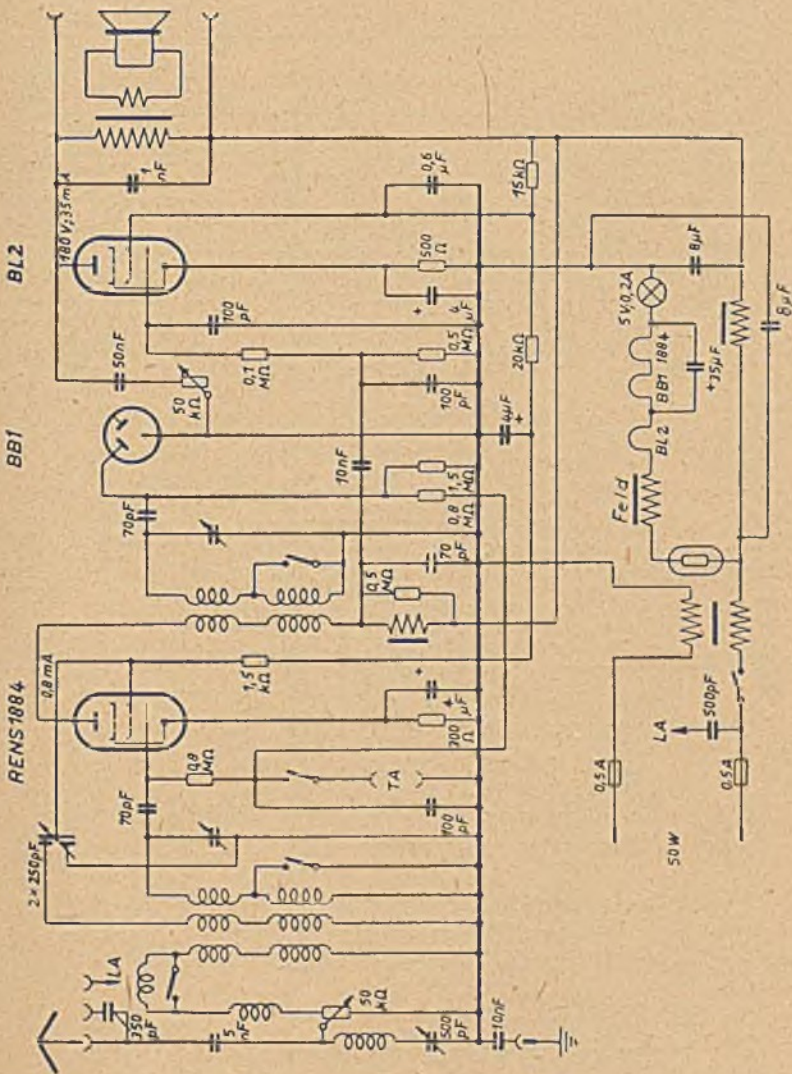

Braun **Trumpf-Junior 550 W** (Bakelit-Gehäuse)
 " " **560 W** (Holz-Gehäuse, braun)
 " " **570 W** (550 W und Phono)
 " " **580 W** (550 W Holz-Gehäuse,
 schwarz)

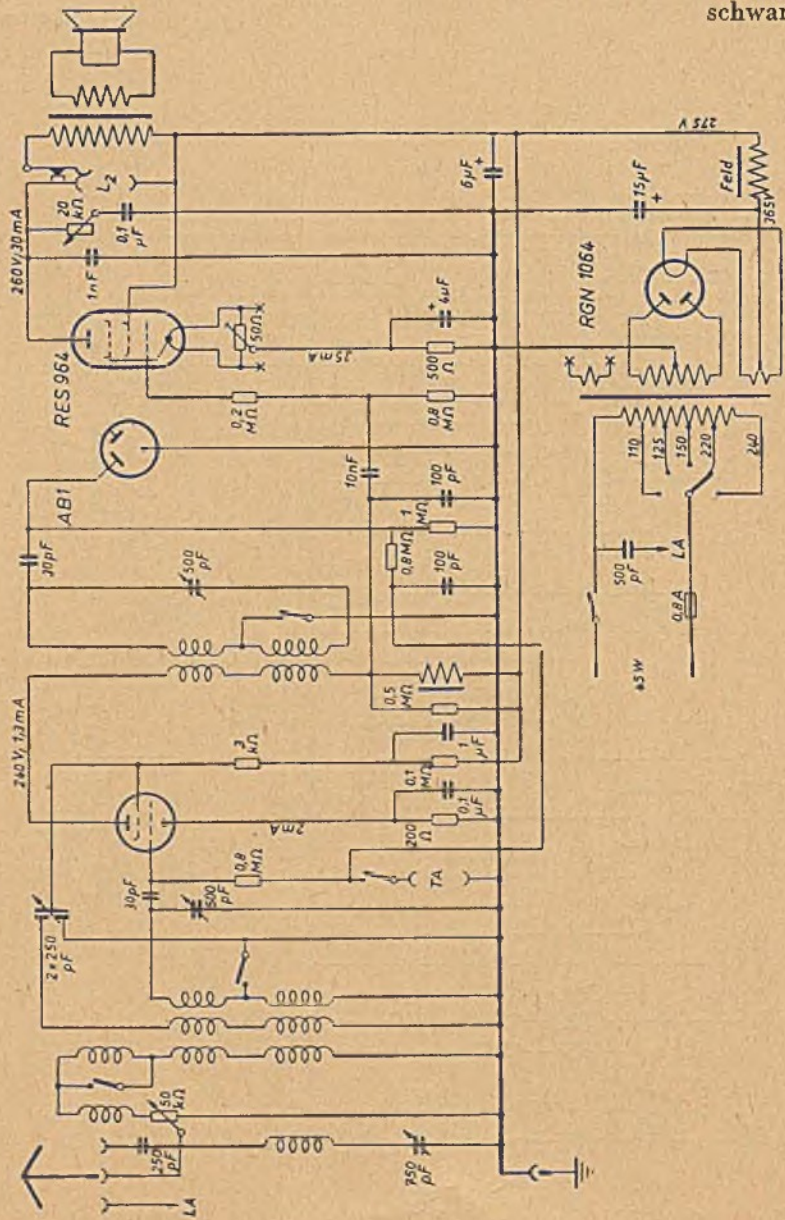

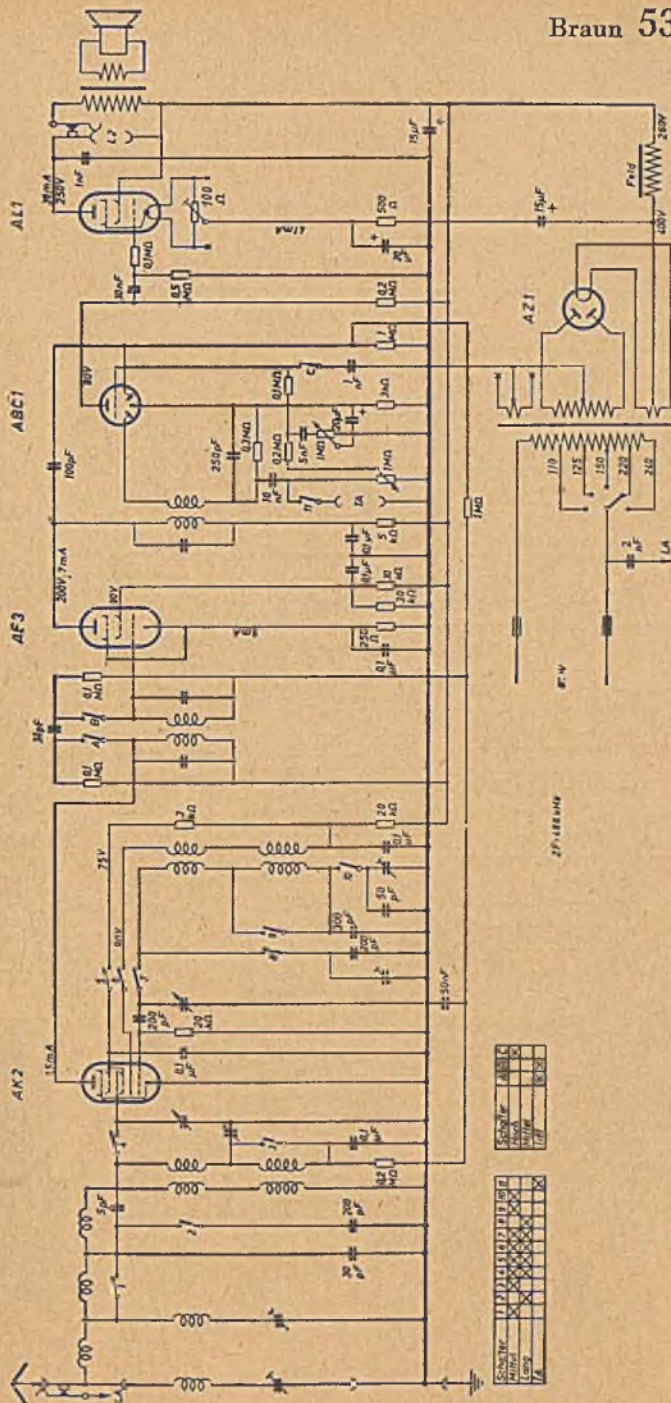

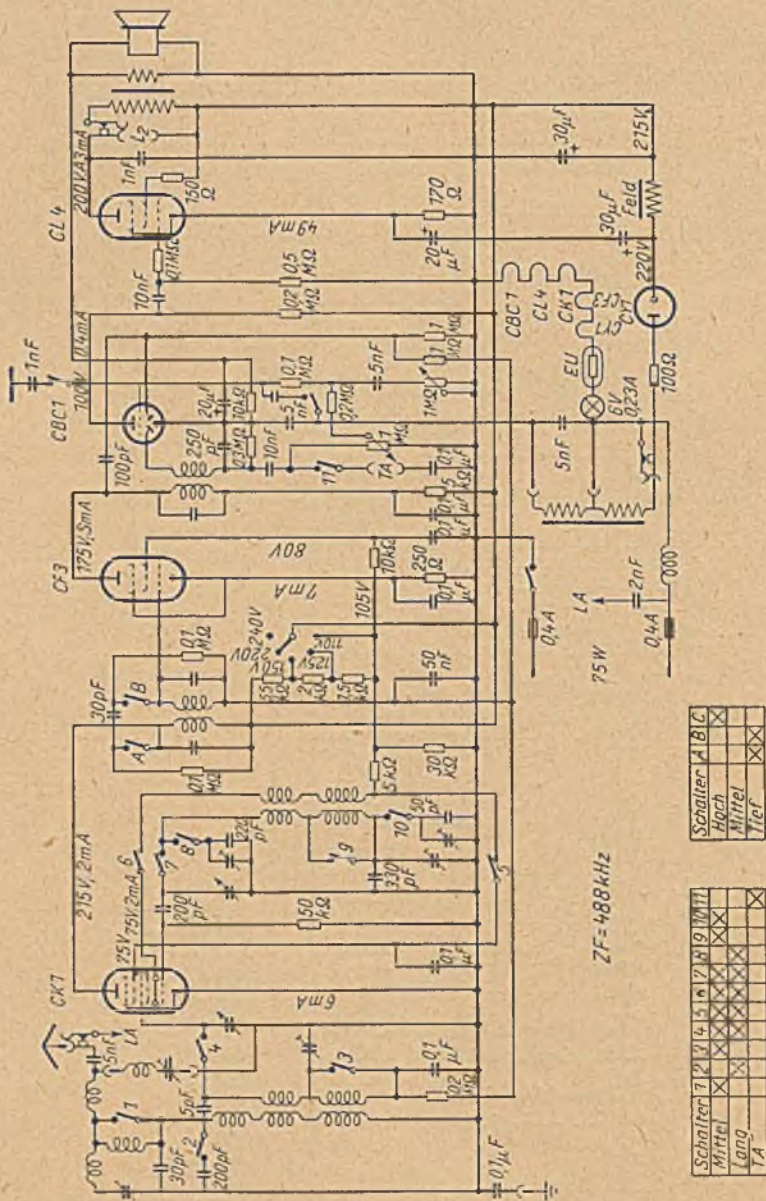

Braun **Trumpf 525 GL**
 " **545 GL** (525 GL und Phono)

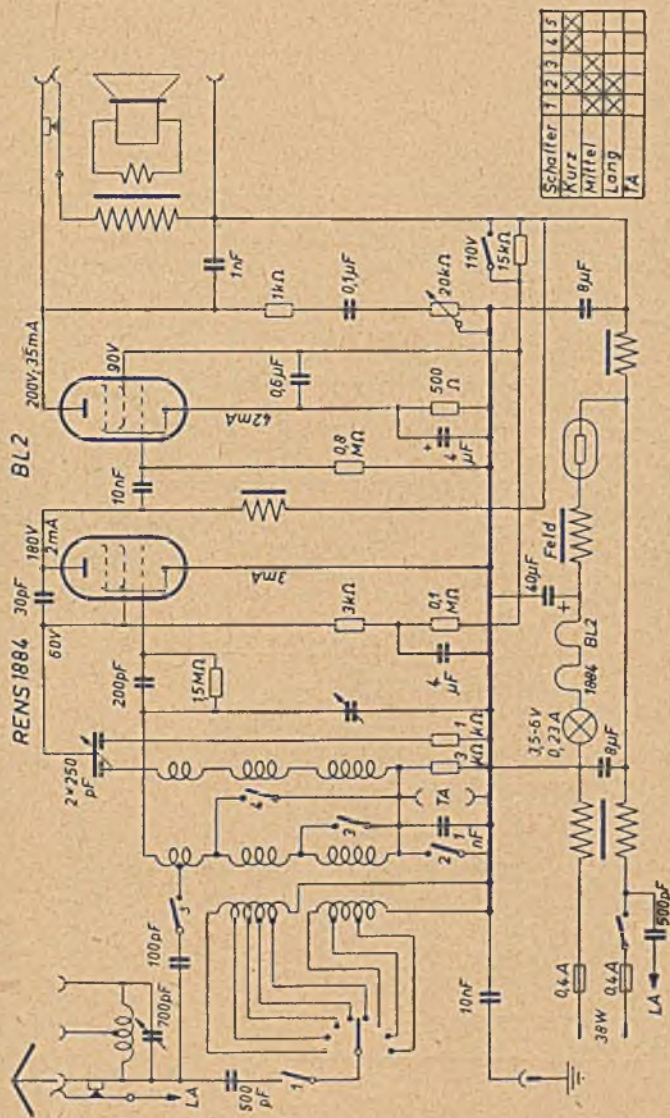

Schalter	1	2	3	4	5
Kurz	<input checked="" type="checkbox"/>	<input checked="" type="checkbox"/>	<input checked="" type="checkbox"/>	<input checked="" type="checkbox"/>	<input checked="" type="checkbox"/>
Mittel	<input checked="" type="checkbox"/>	<input checked="" type="checkbox"/>	<input checked="" type="checkbox"/>	<input checked="" type="checkbox"/>	<input checked="" type="checkbox"/>
Lang	<input checked="" type="checkbox"/>	<input checked="" type="checkbox"/>	<input checked="" type="checkbox"/>	<input checked="" type="checkbox"/>	<input checked="" type="checkbox"/>
TA	<input checked="" type="checkbox"/>	<input checked="" type="checkbox"/>	<input checked="" type="checkbox"/>	<input checked="" type="checkbox"/>	<input checked="" type="checkbox"/>

Braun Trumpf 515 GL
 " 535 GL (515 GL und Phono)

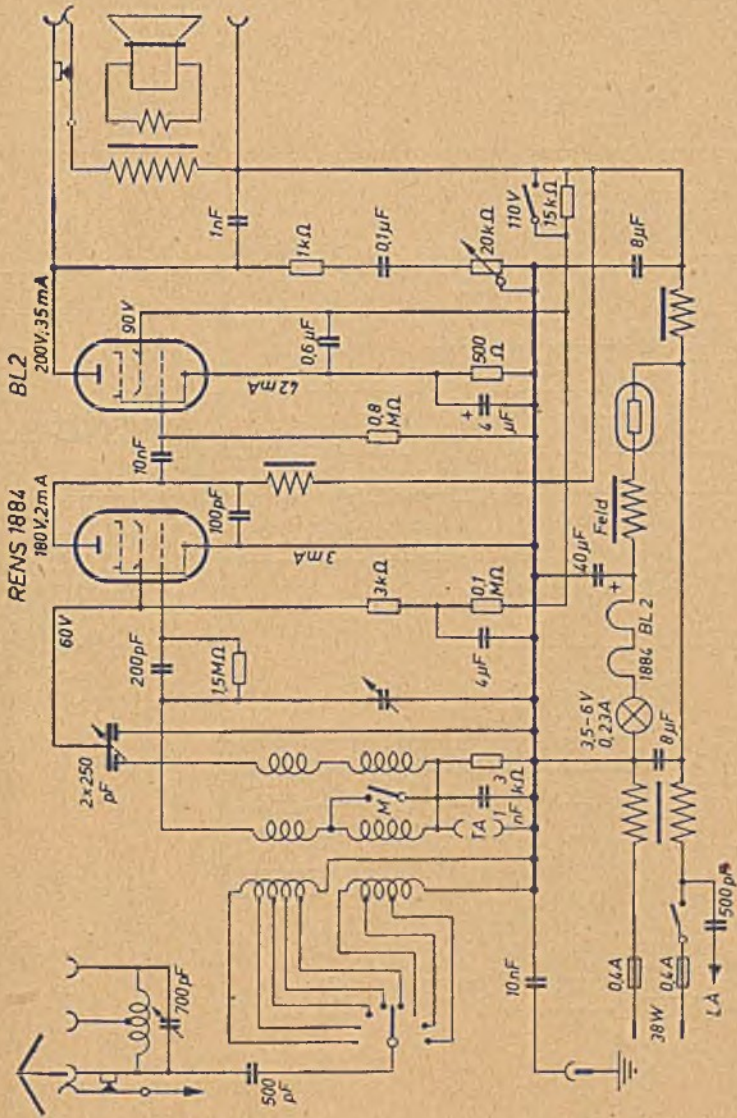

Braun **Trumpf 510 W**
 " **530 W** (510 W und Phono)

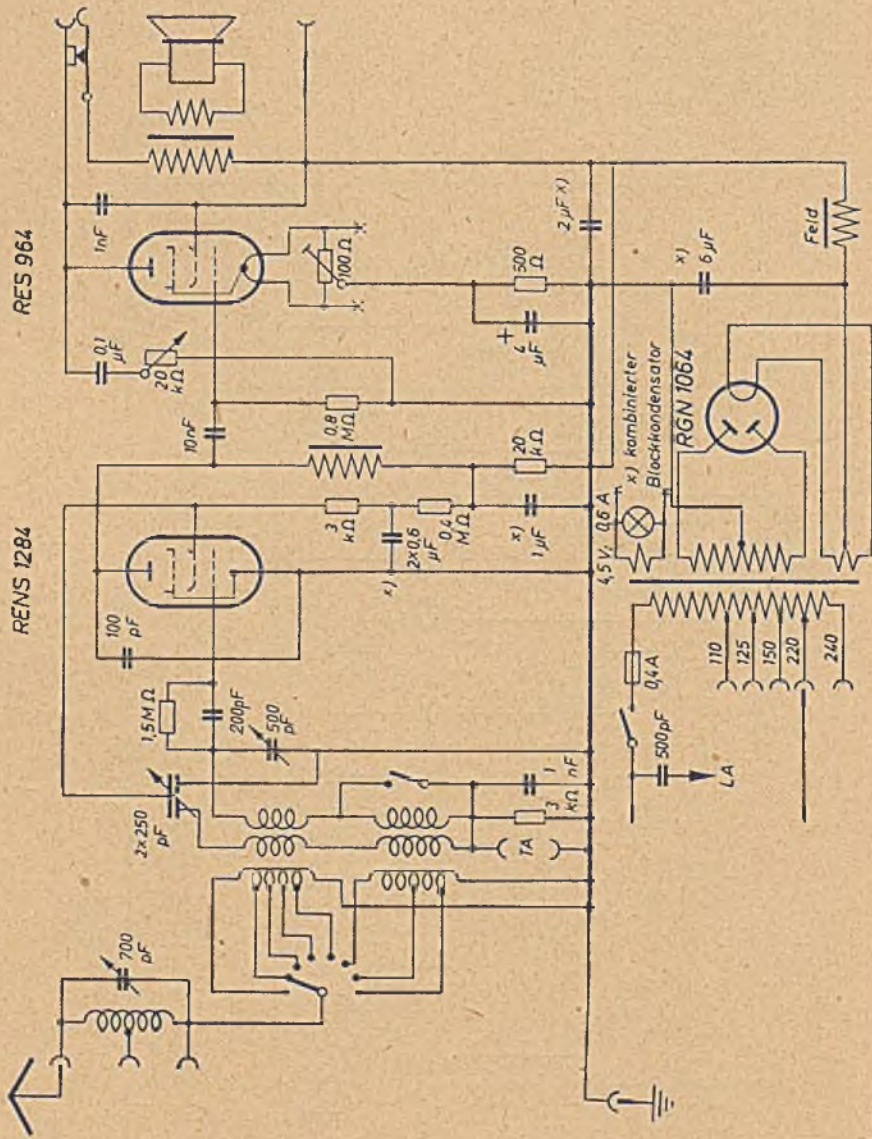

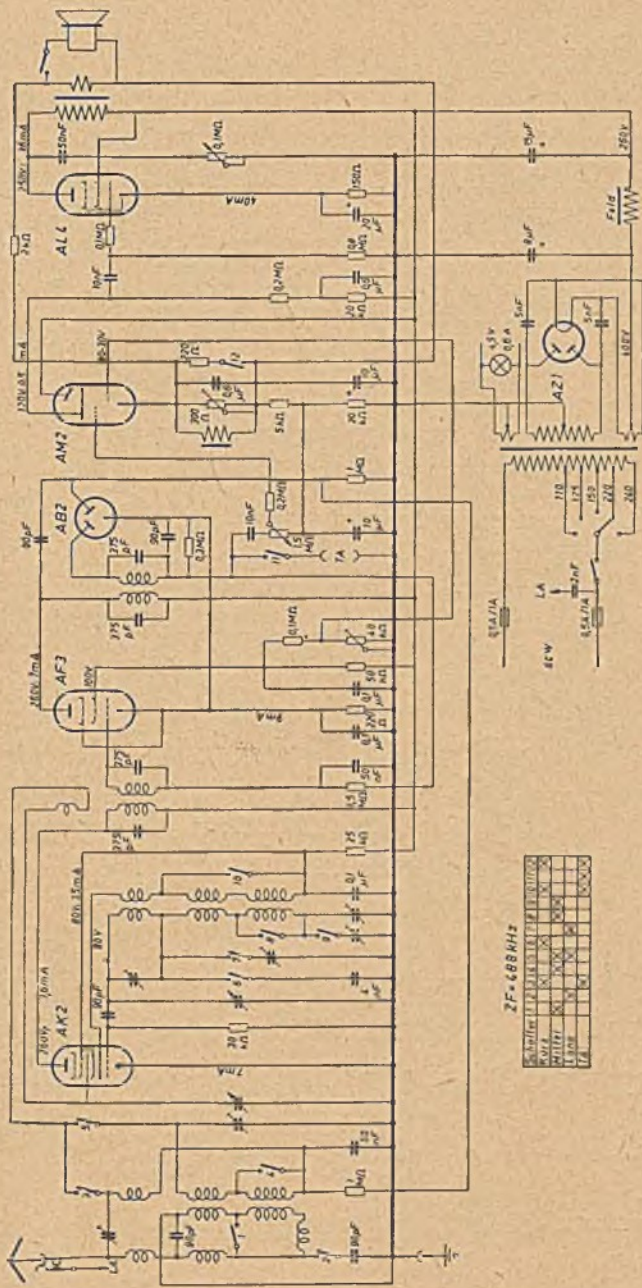

ZF = 688 kHz

Schaltstellung	1	2	3	4	5	6	7	8	9	10	11	12	13	14	15
KW	1	2	3	4	5	6	7	8	9	10	11	12	13	14	15
W	1	2	3	4	5	6	7	8	9	10	11	12	13	14	15
L	1	2	3	4	5	6	7	8	9	10	11	12	13	14	15
H	1	2	3	4	5	6	7	8	9	10	11	12	13	14	15

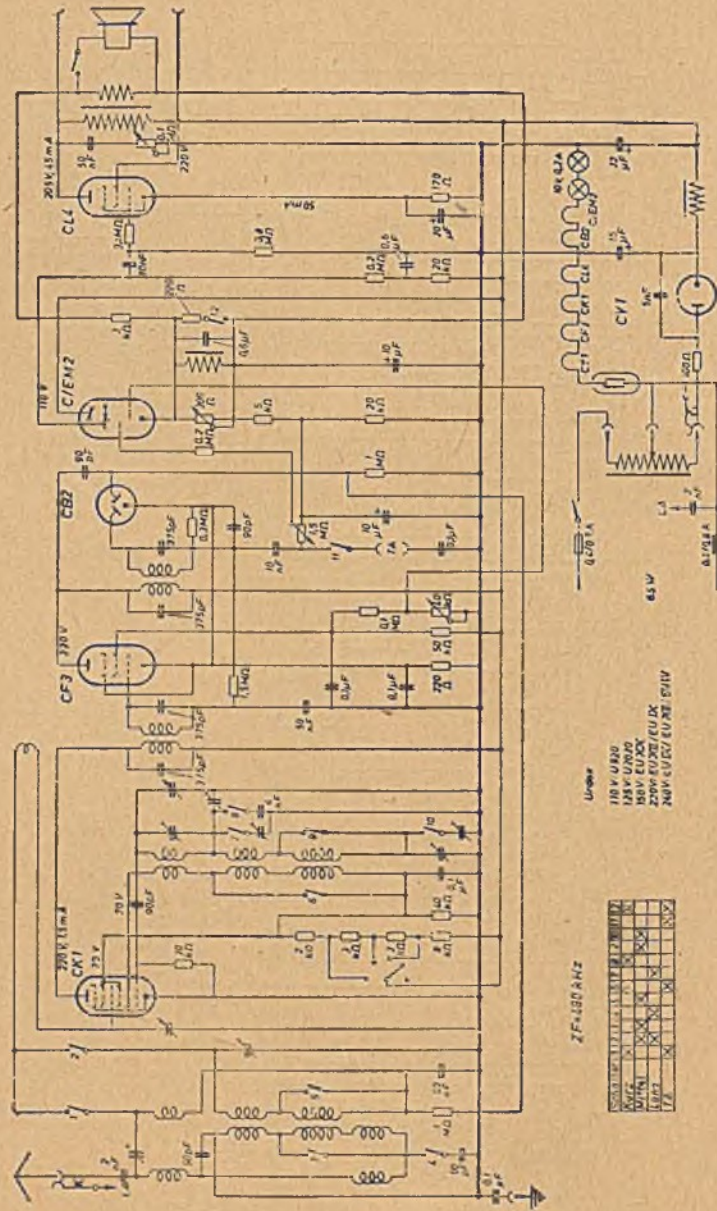

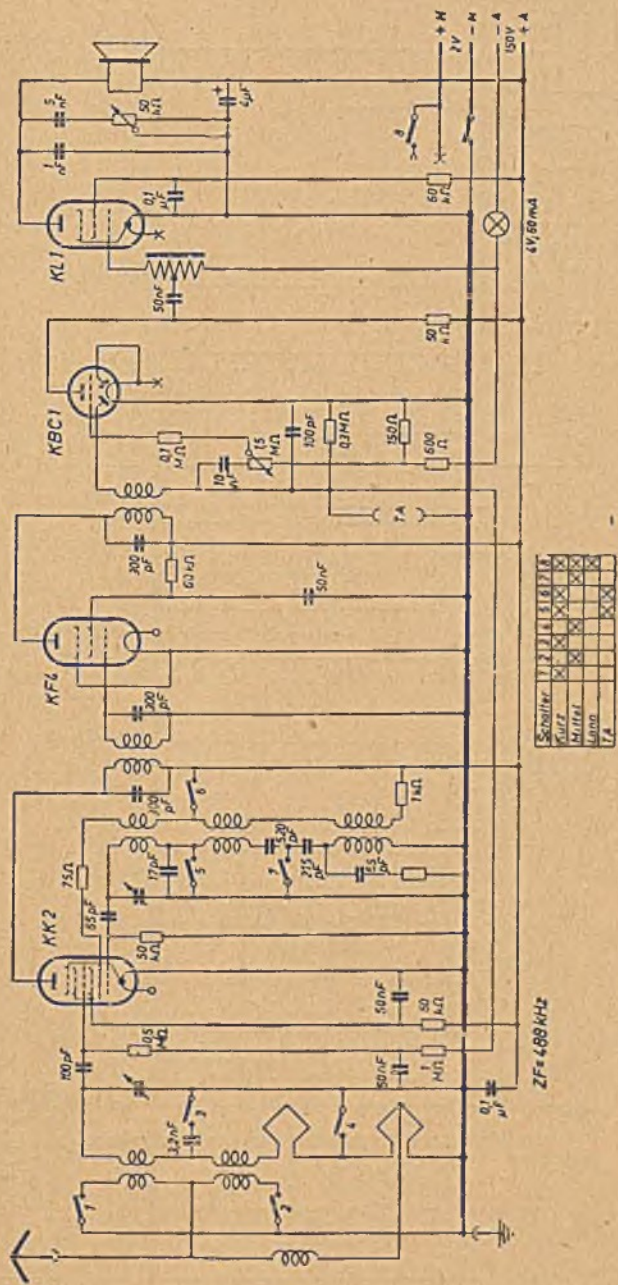

Braun BSK 239 D

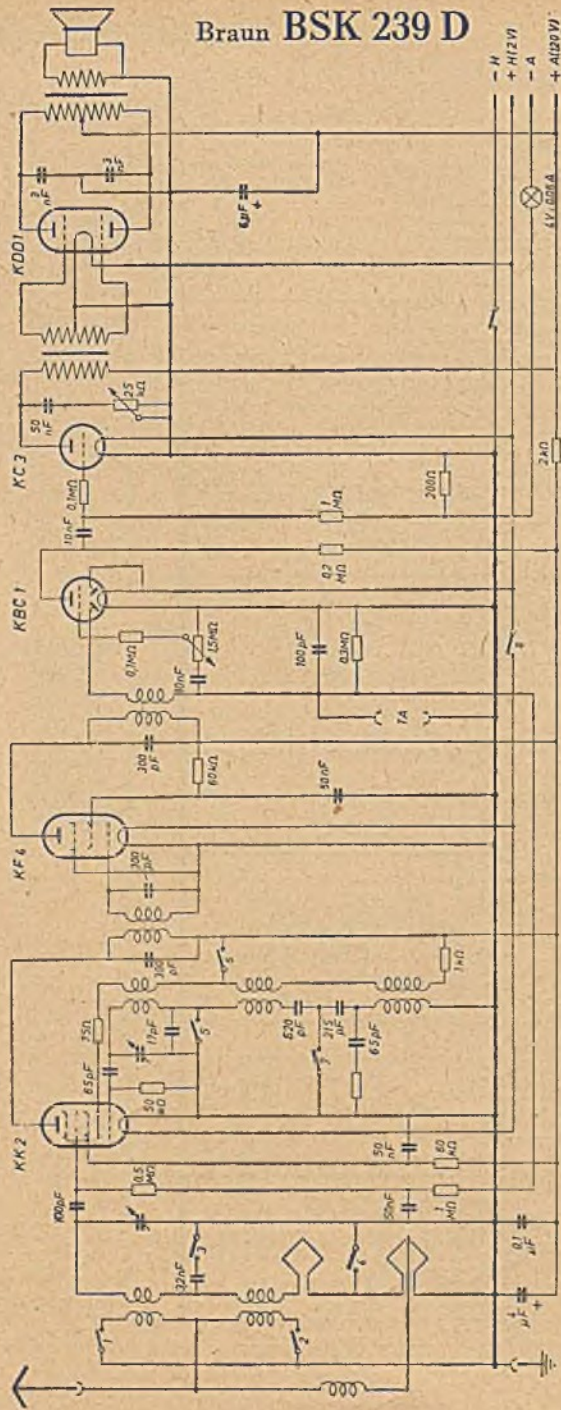

ZF: 488 kHz

SW/gleiter	1	2	3	4	5	6	7	8	9	10	11	12	13	14
Ant	X	X	X	X	X	X	X	X	X	X	X	X	X	X
Antip	X	X	X	X	X	X	X	X	X	X	X	X	X	X
Lang	X	X	X	X	X	X	X	X	X	X	X	X	X	X
TA	X	X	X	X	X	X	X	X	X	X	X	X	X	X

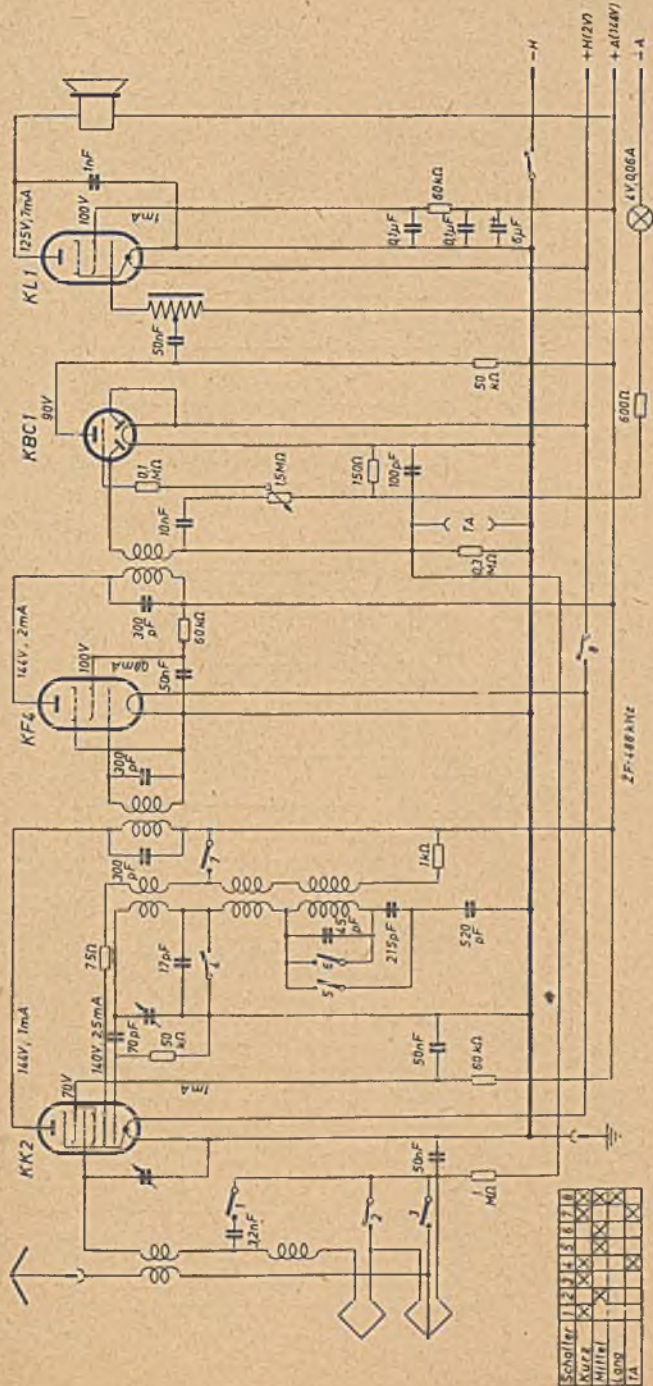

Schalter	1	2	3	4	5	6	7	8	9	10
Kurz	X	X	X	X	X	X	X	X	X	X
Mittel	X	X	X	X	X	X	X	X	X	X
Lang	X	X	X	X	X	X	X	X	X	X
TA	X	X	X	X	X	X	X	X	X	X

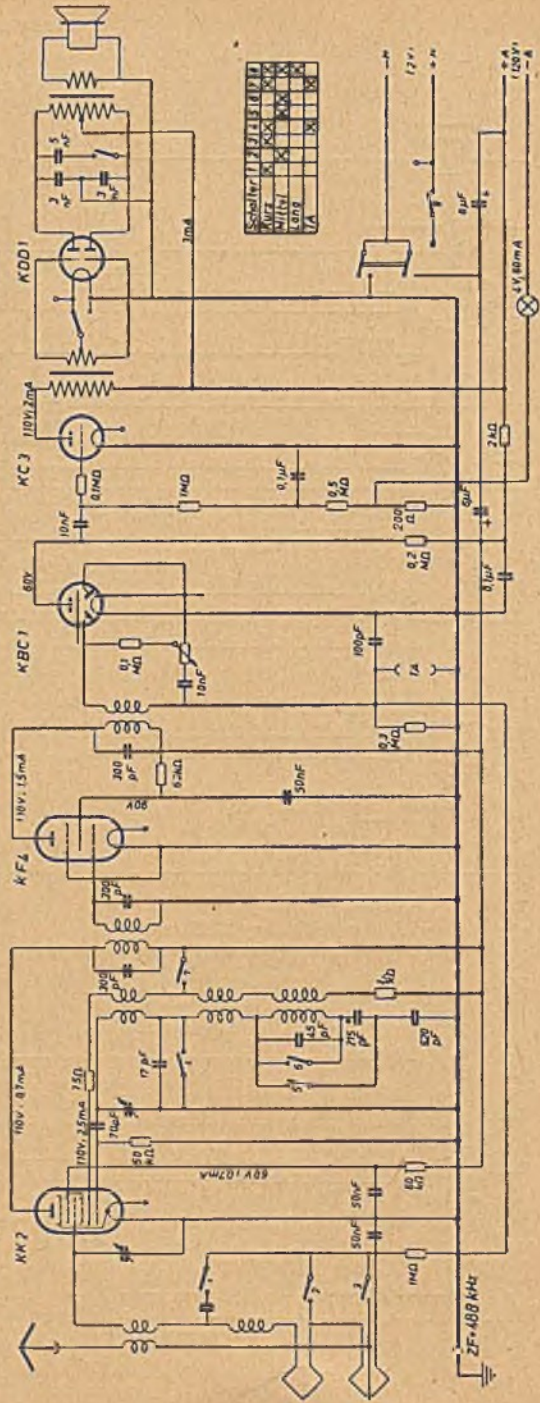

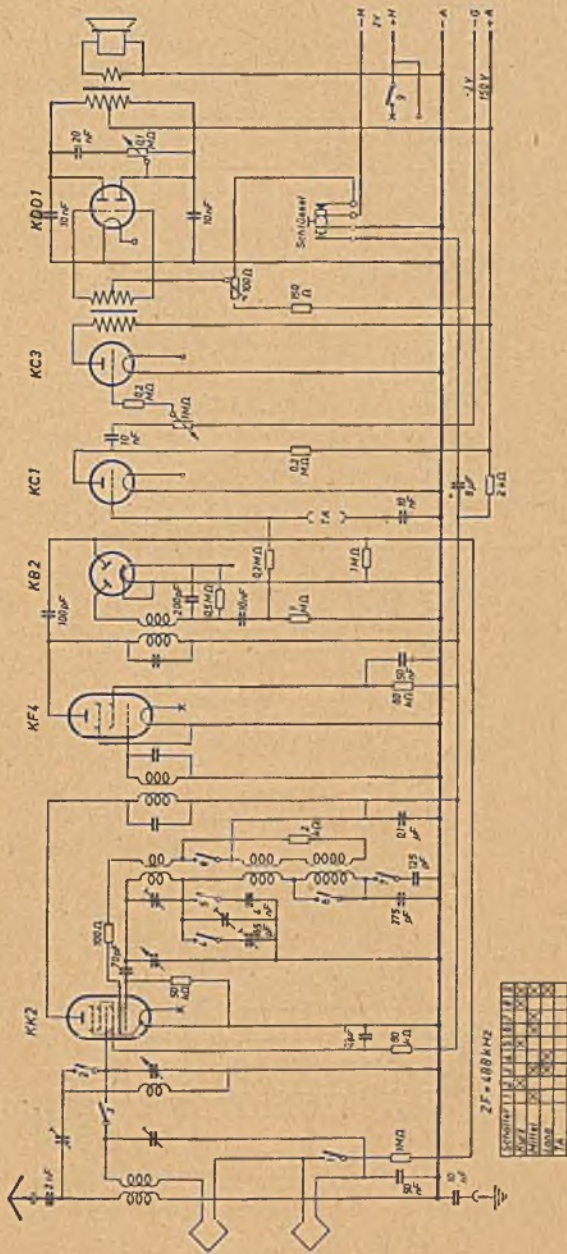

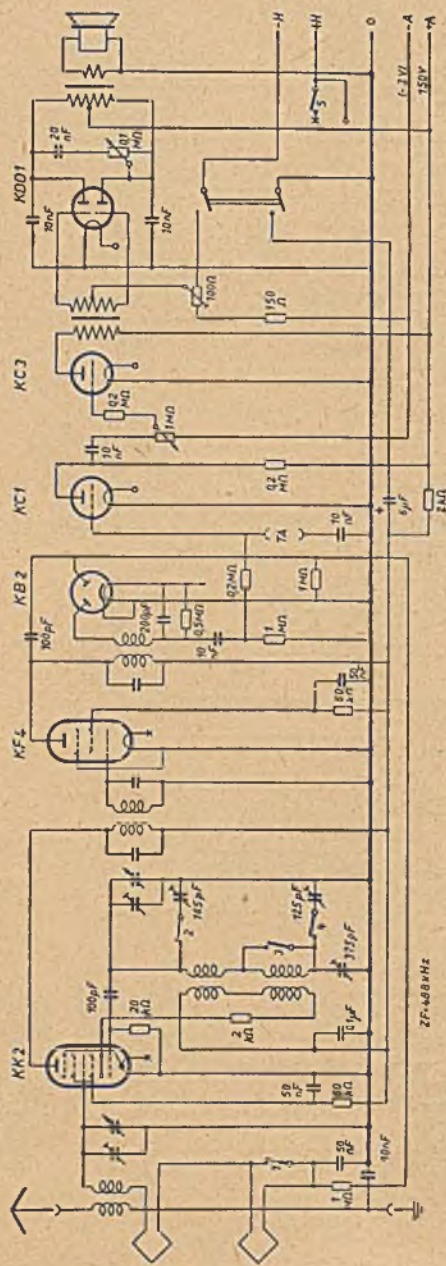

1	2	3	4	5
6	7	8	9	10
11	12	13	14	15
16	17	18	19	20

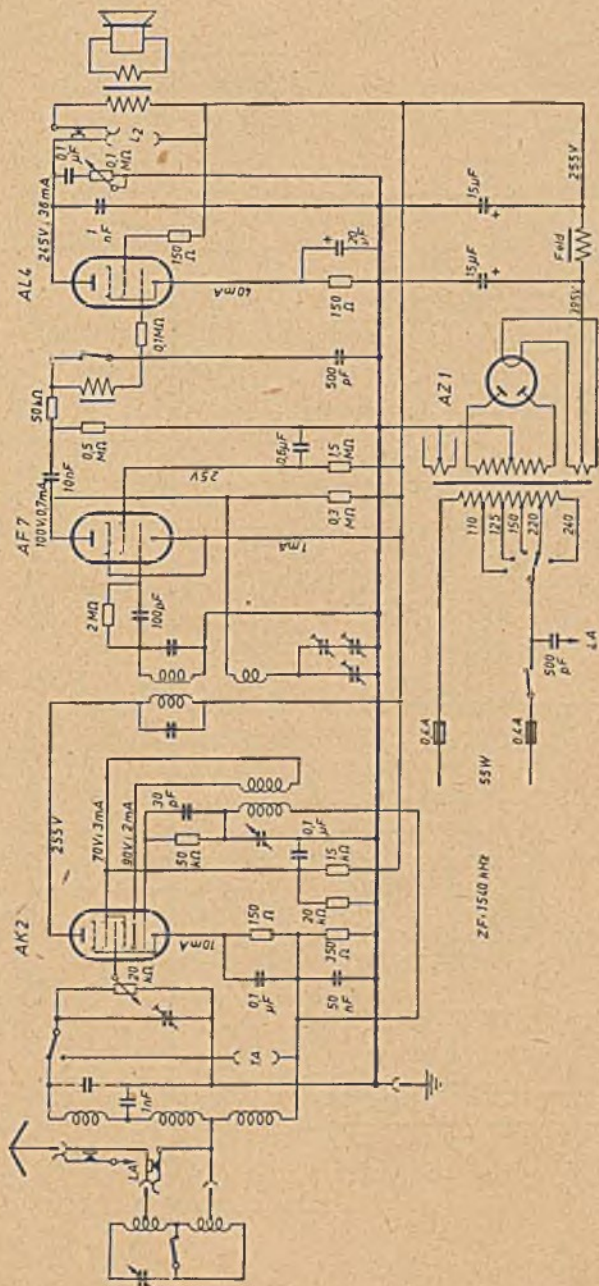

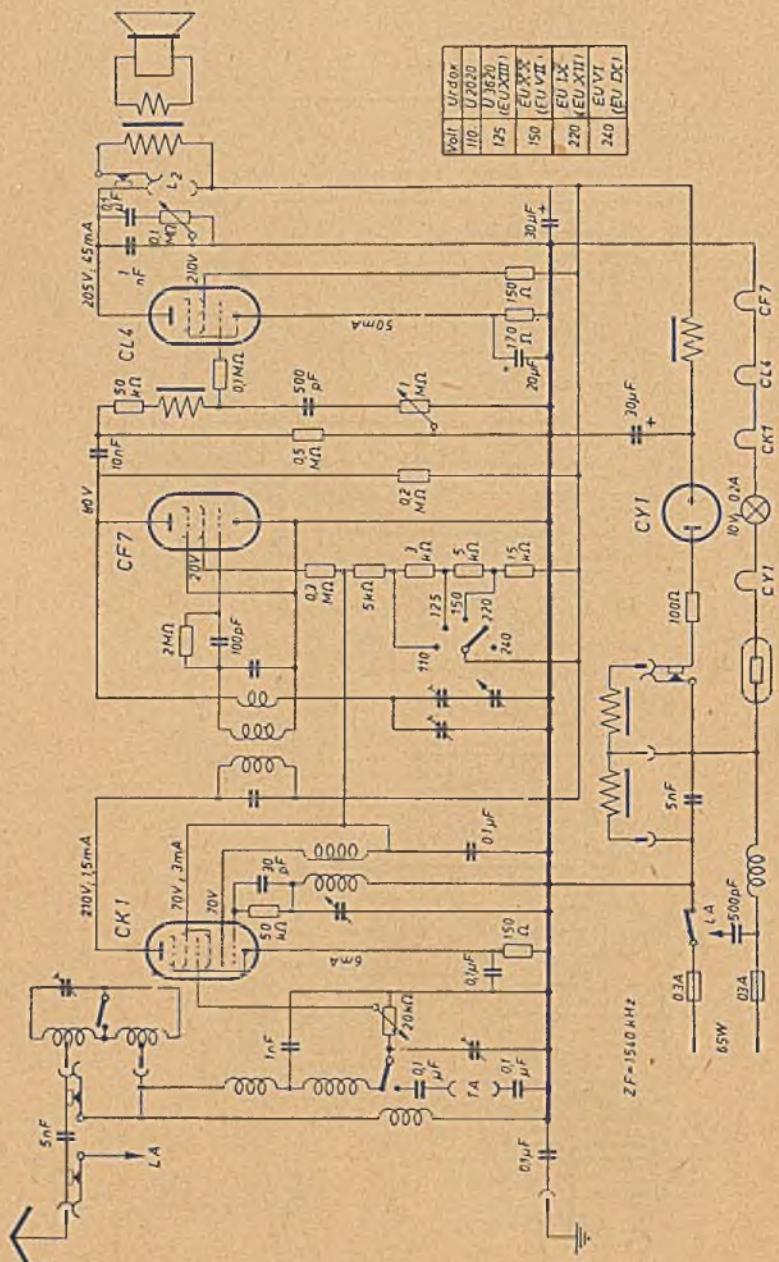

Volt	Urdot
110	U 2030
125	U 3620 (EU XXII)
150	EU XX (EU VI)
220	EU IX (EU VII)
240	EU VI (EU DC)

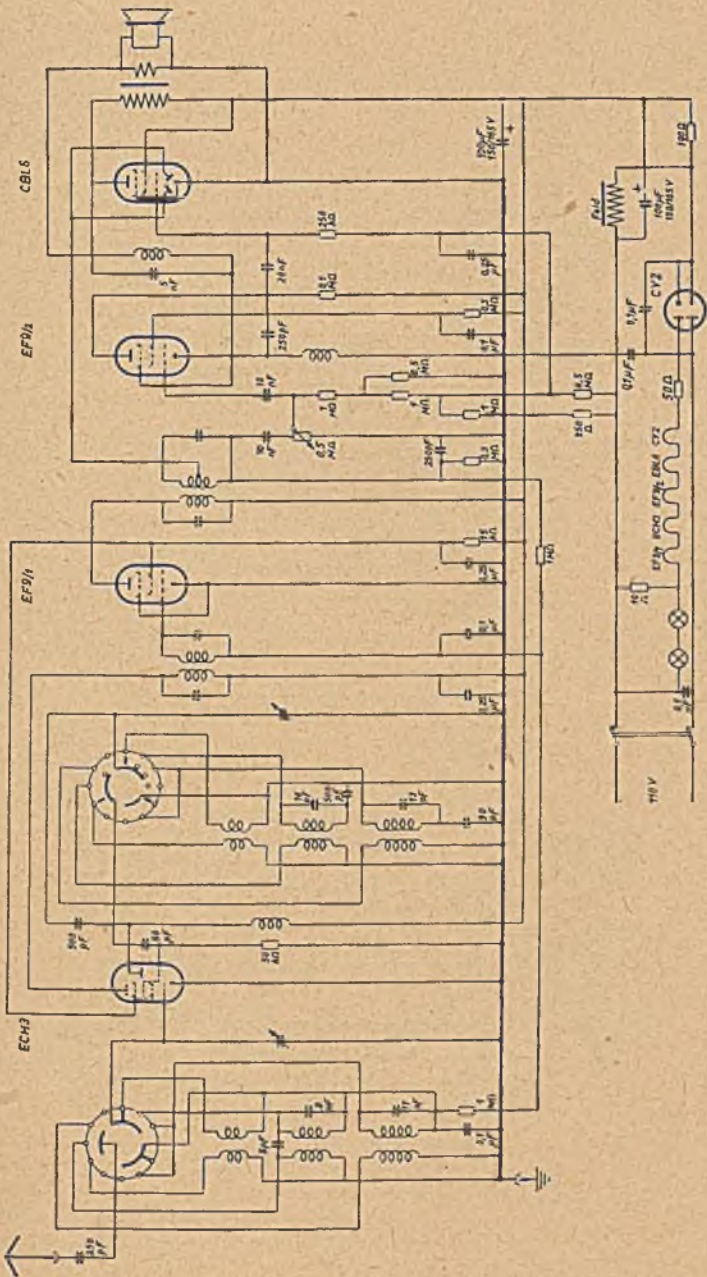

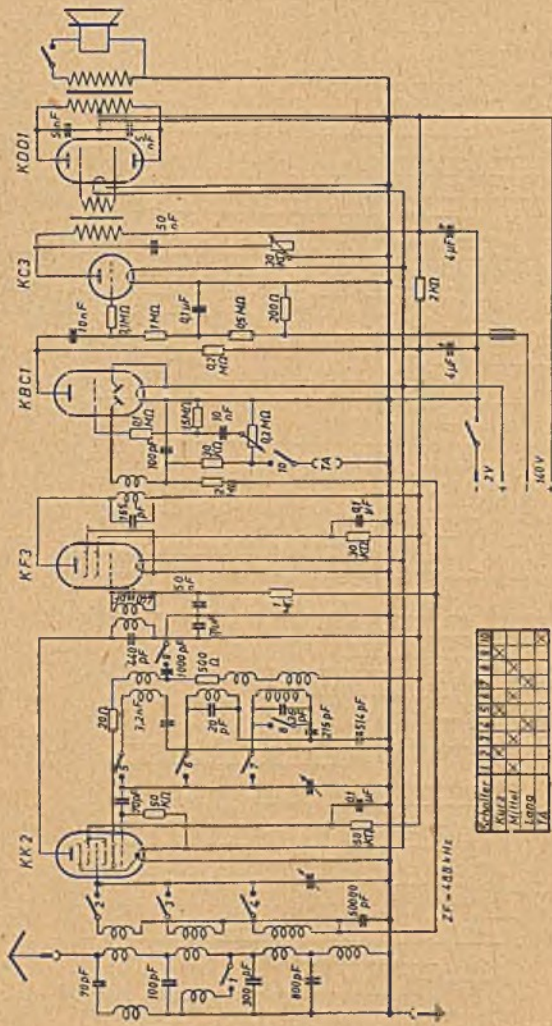

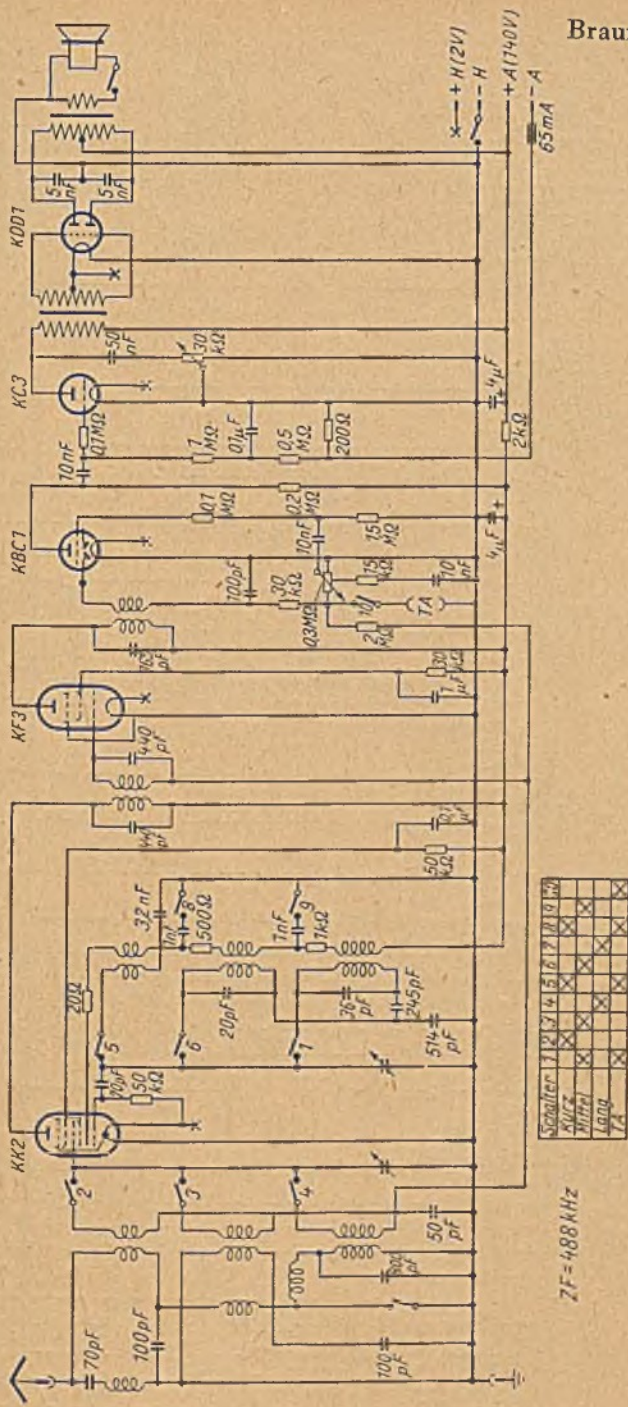

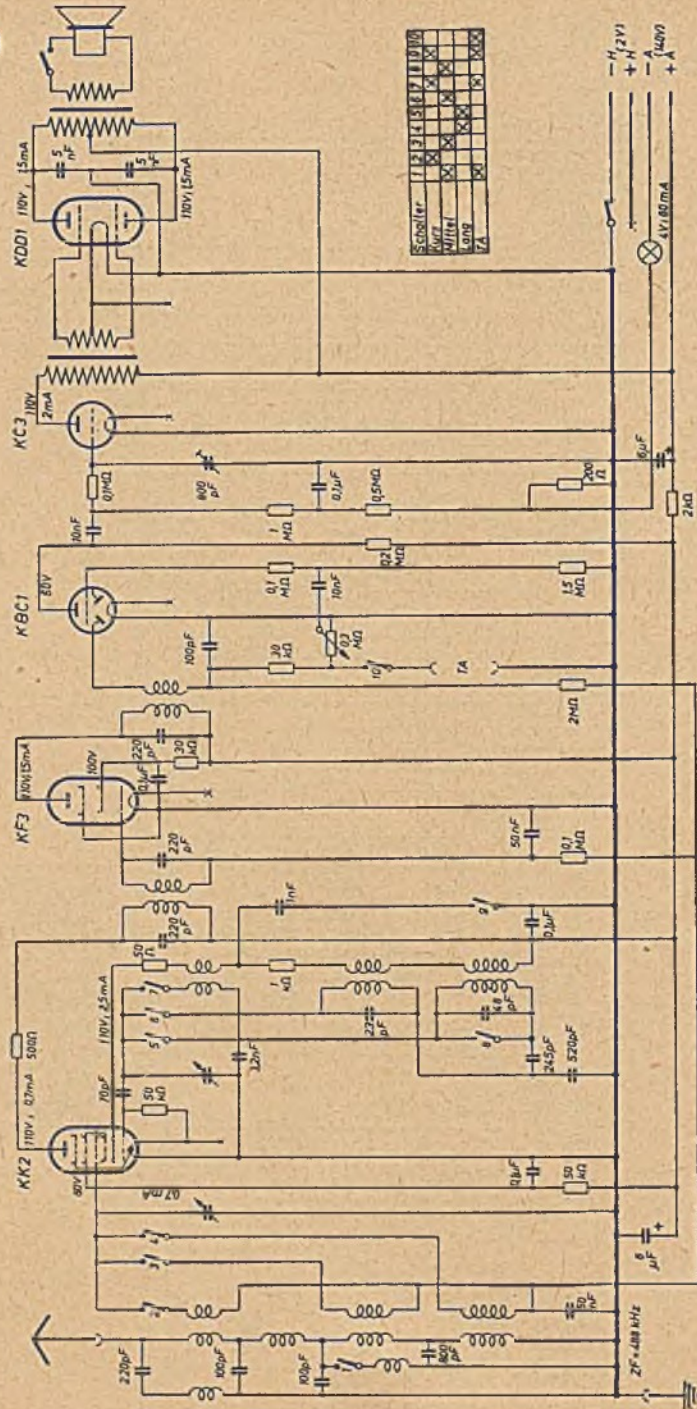

Schaltver.	1	2	3	4	5	6	7	8	9	10
KV1		X								
KV2										
KV3										
KV4										
KV5										
KV6										
KV7										

Braun
BS 37

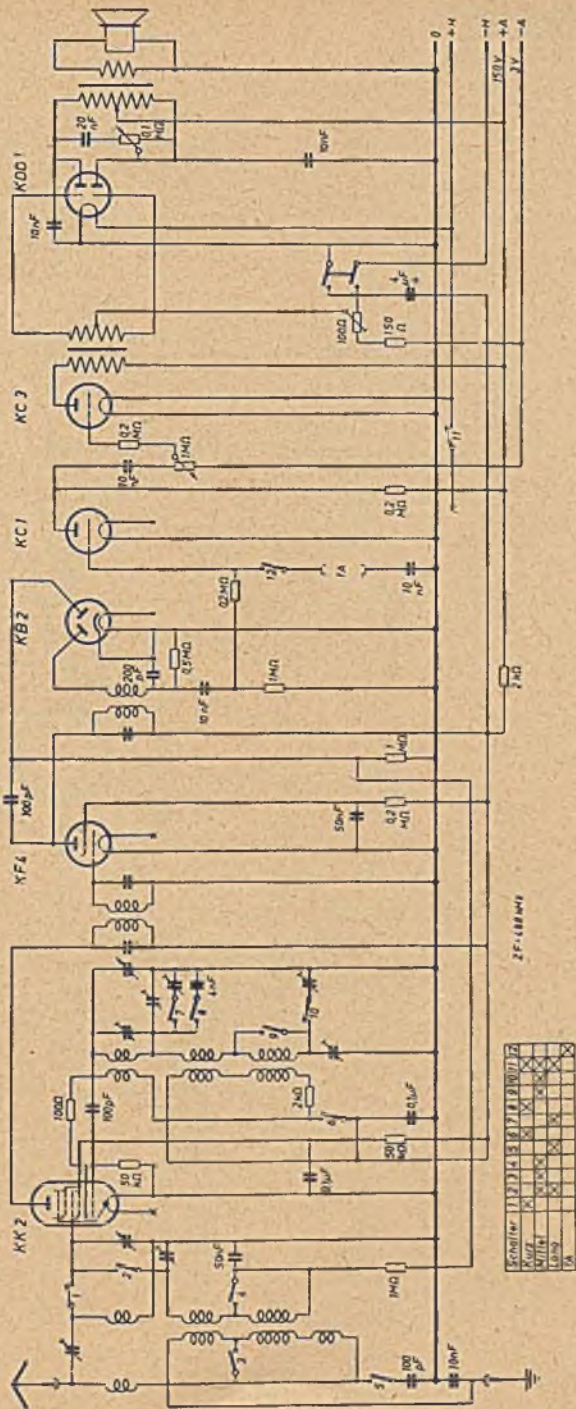

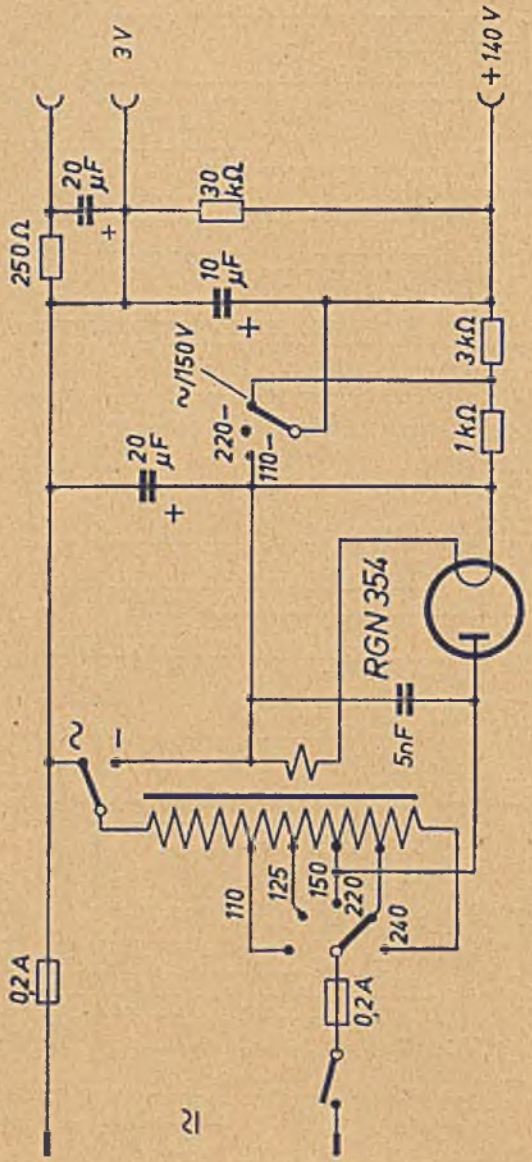

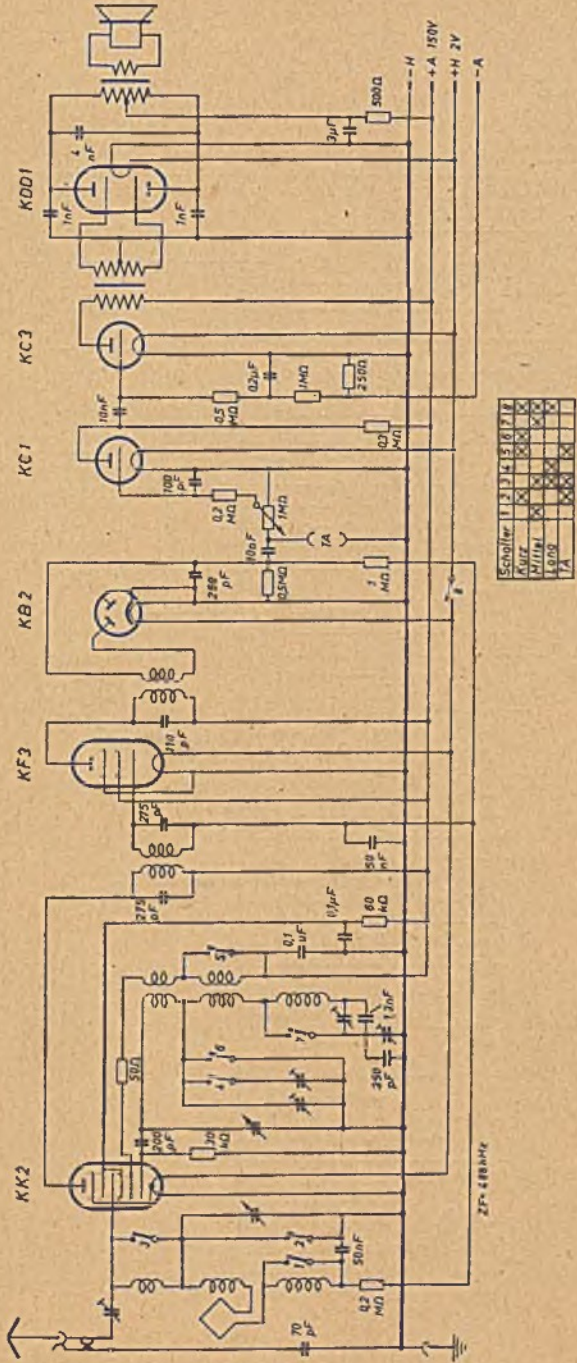

Schalter	1	2	3	4	5	6	7	8	9	10
Kurz	X	X	X	X	X	X	X	X	X	X
W/T	X	X	X	X	X	X	X	X	X	X
1-0-0-0	X	X	X	X	X	X	X	X	X	X
TA	X	X	X	X	X	X	X	X	X	X

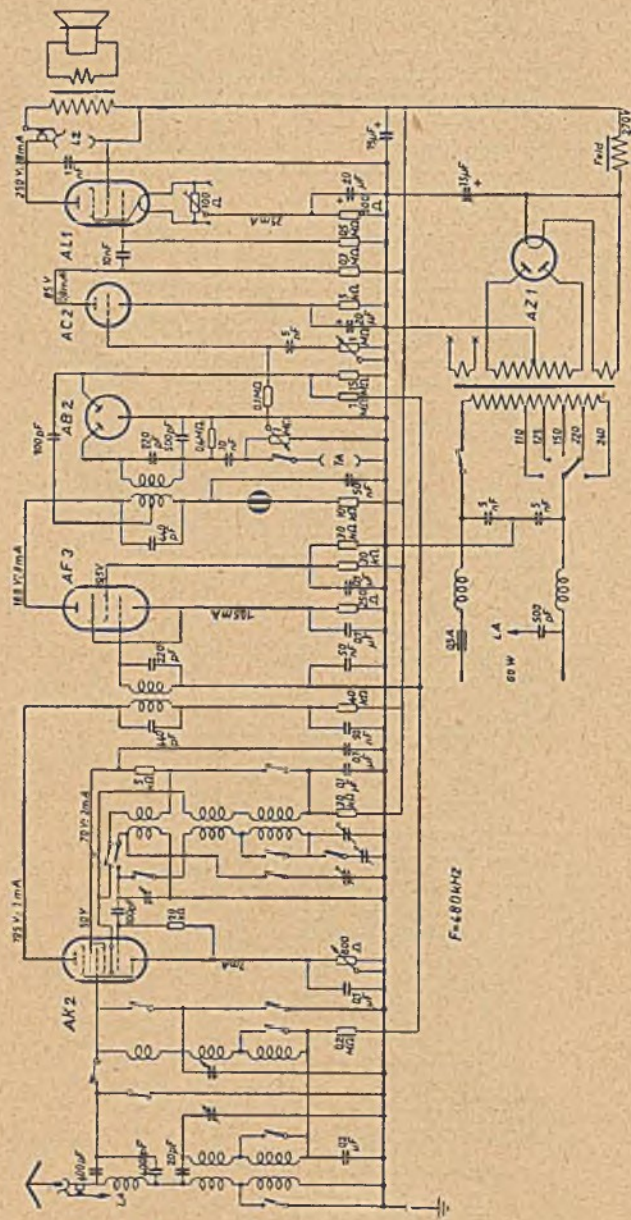

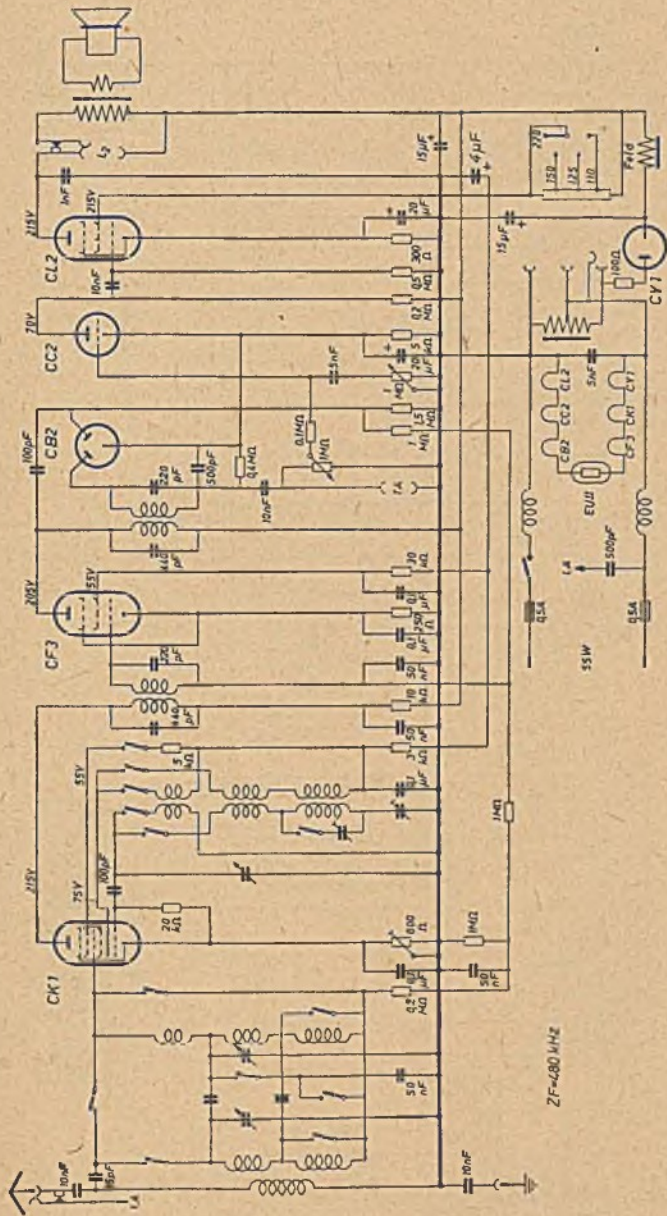

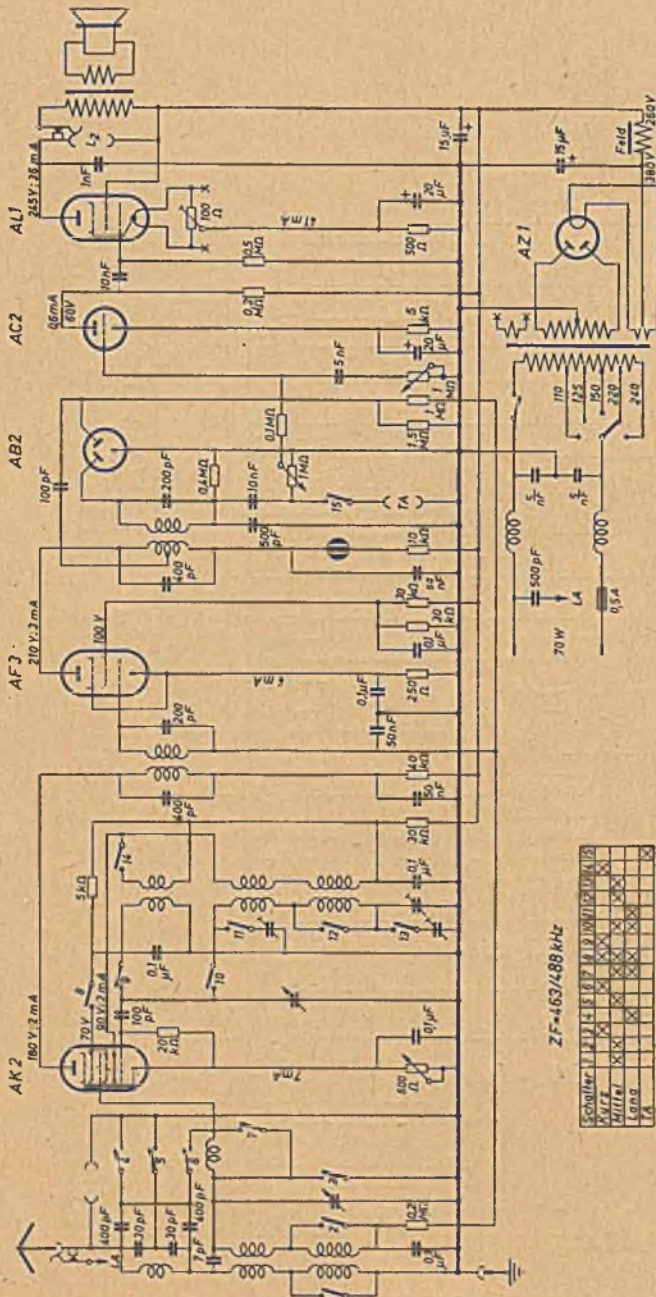

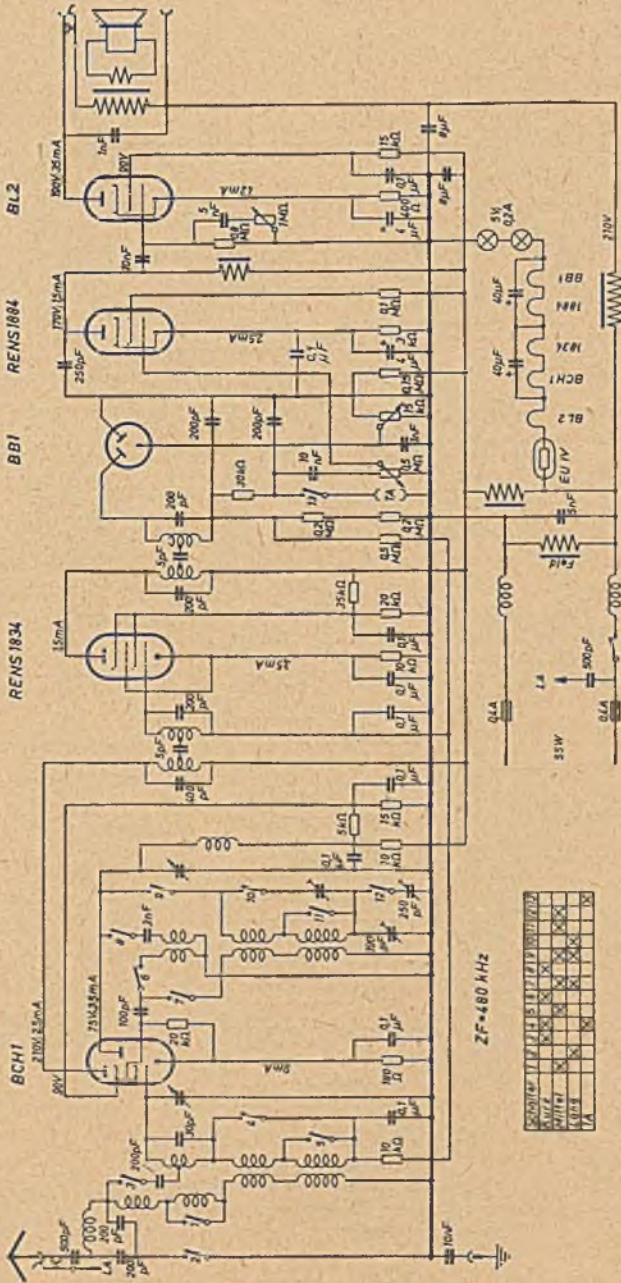

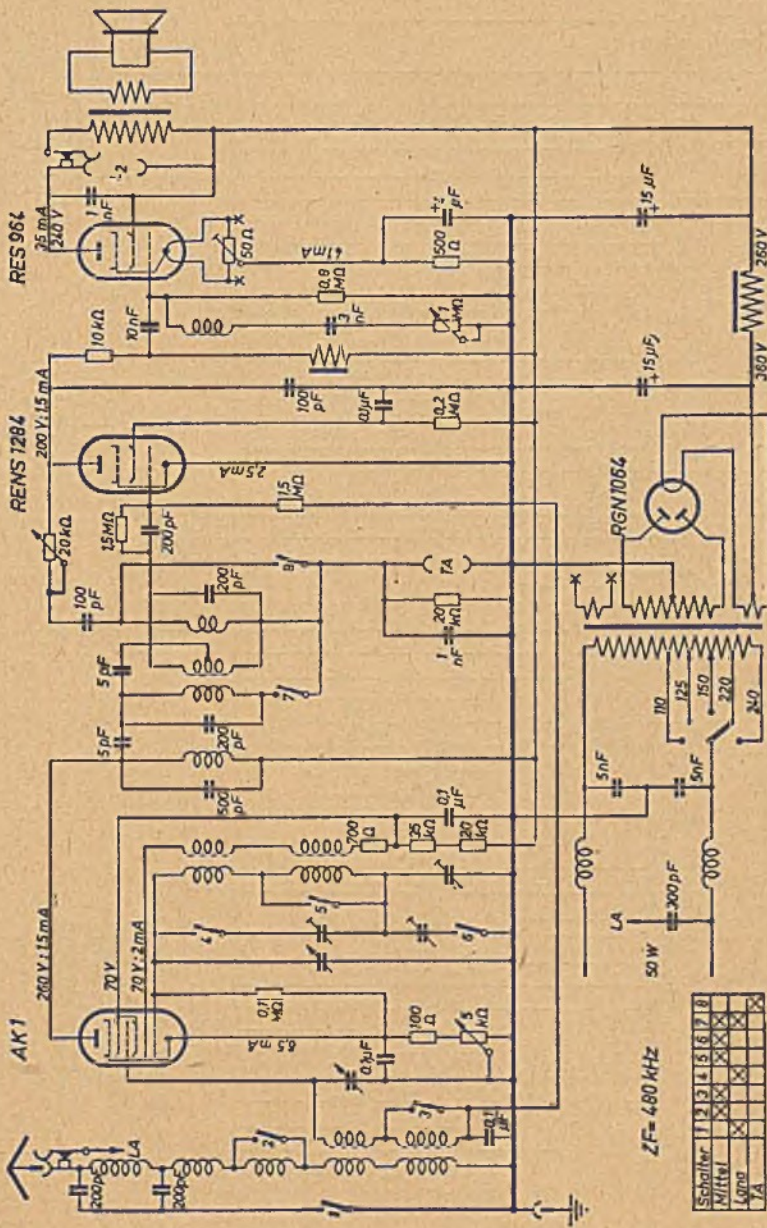

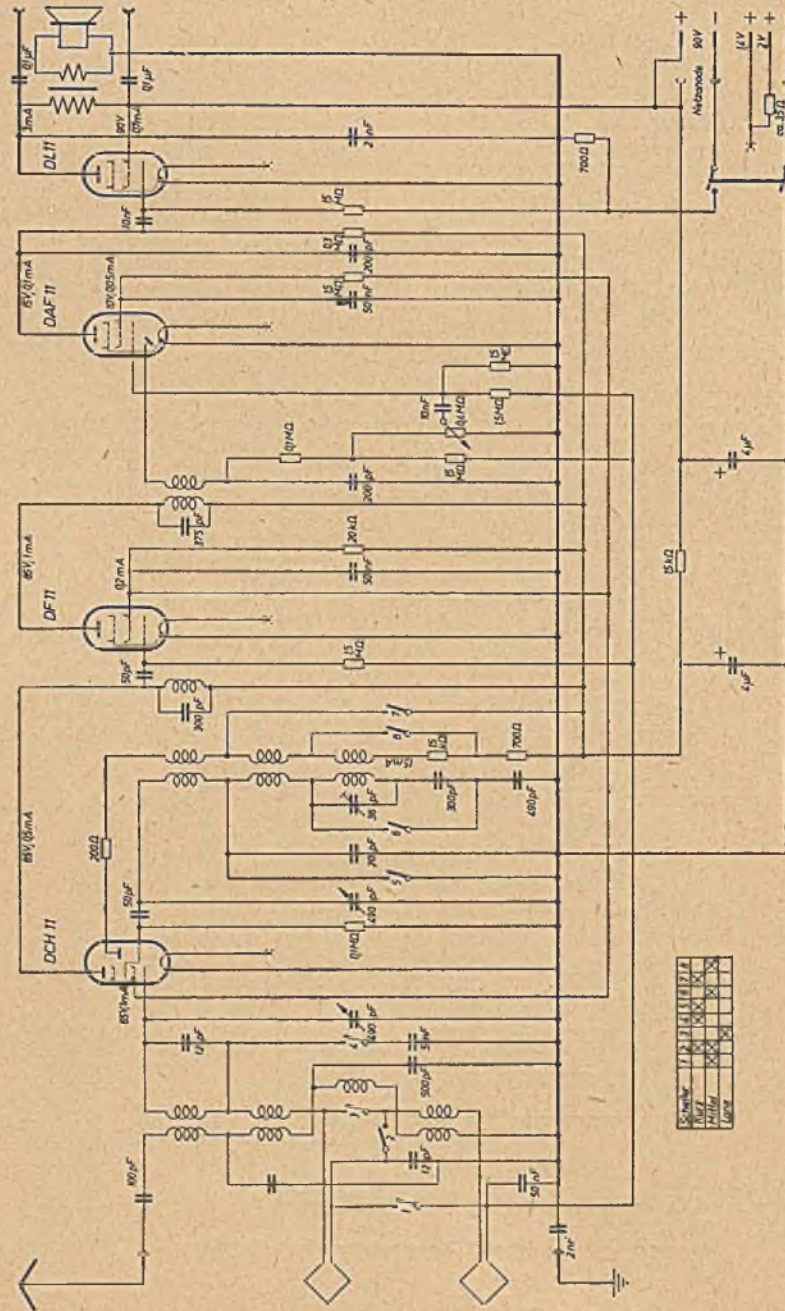

CONTINENTAL

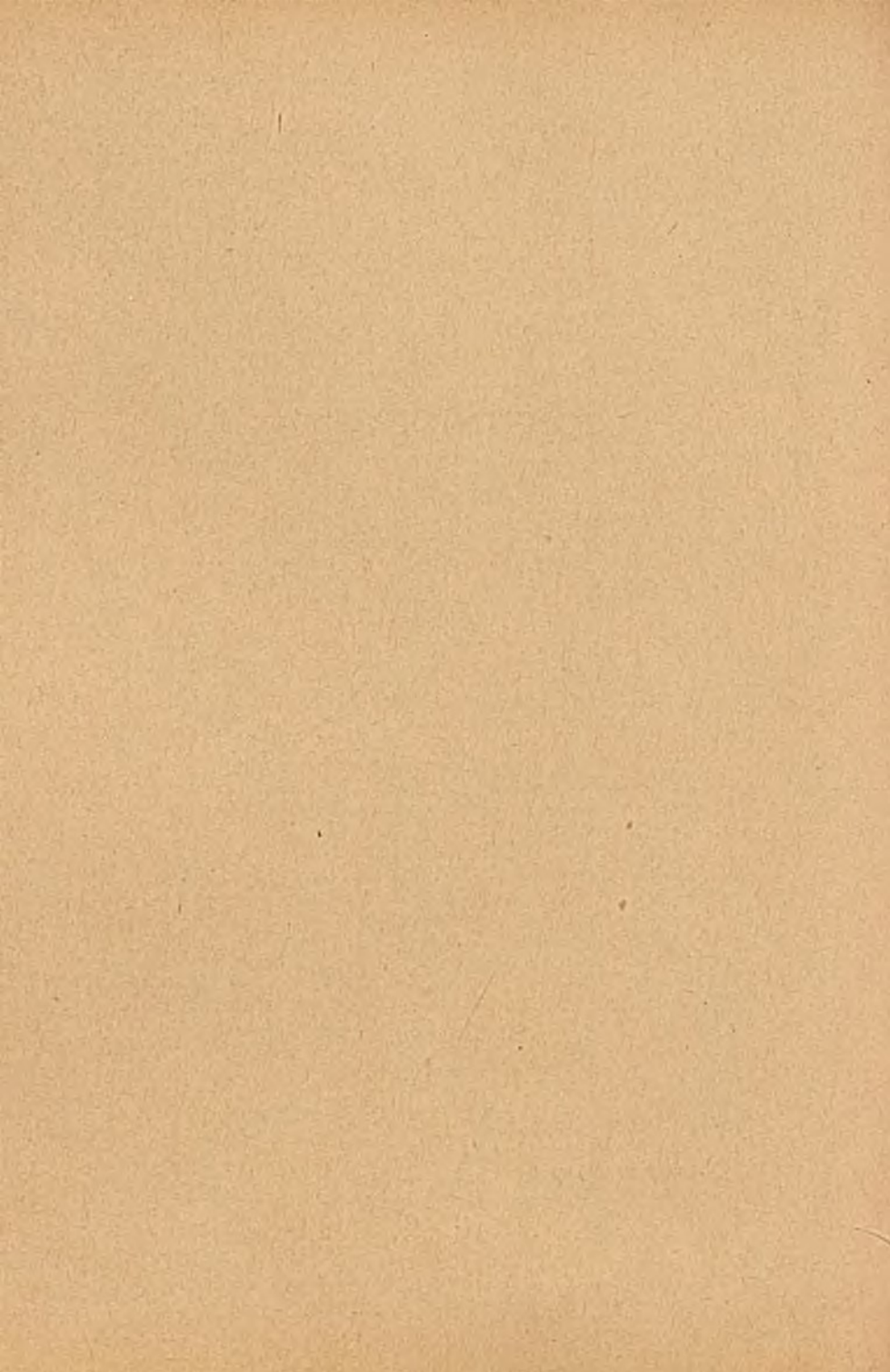

Continental Imperial 660 W

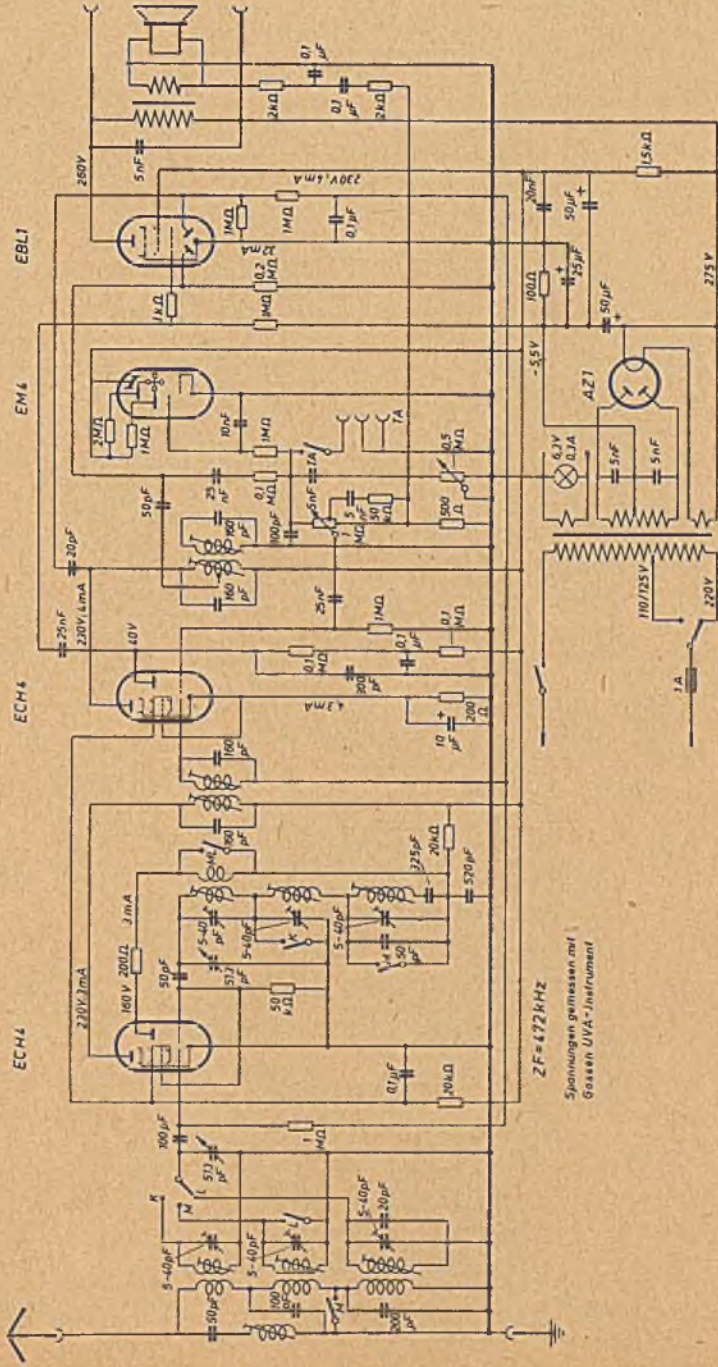

Continental Imperial 61 W (bis Gerät Nr. 3341)

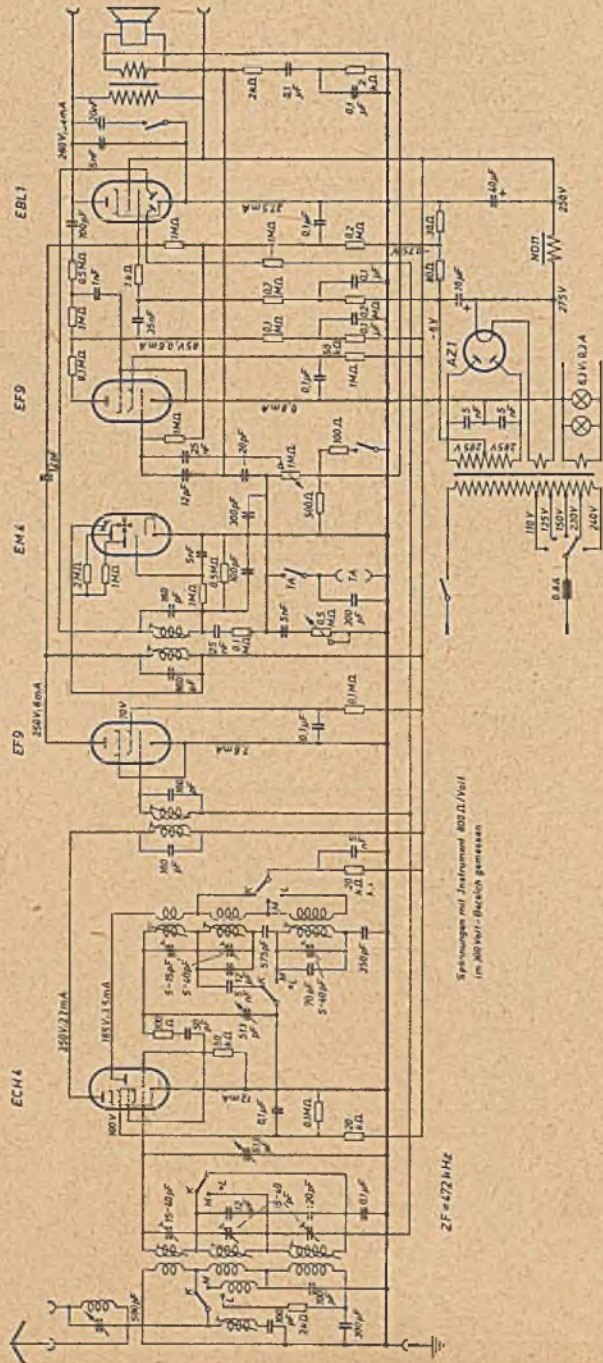

Continental Imperial 61 W mit 2 Lautsprechern
 (ab Gerät Nr. 3342)

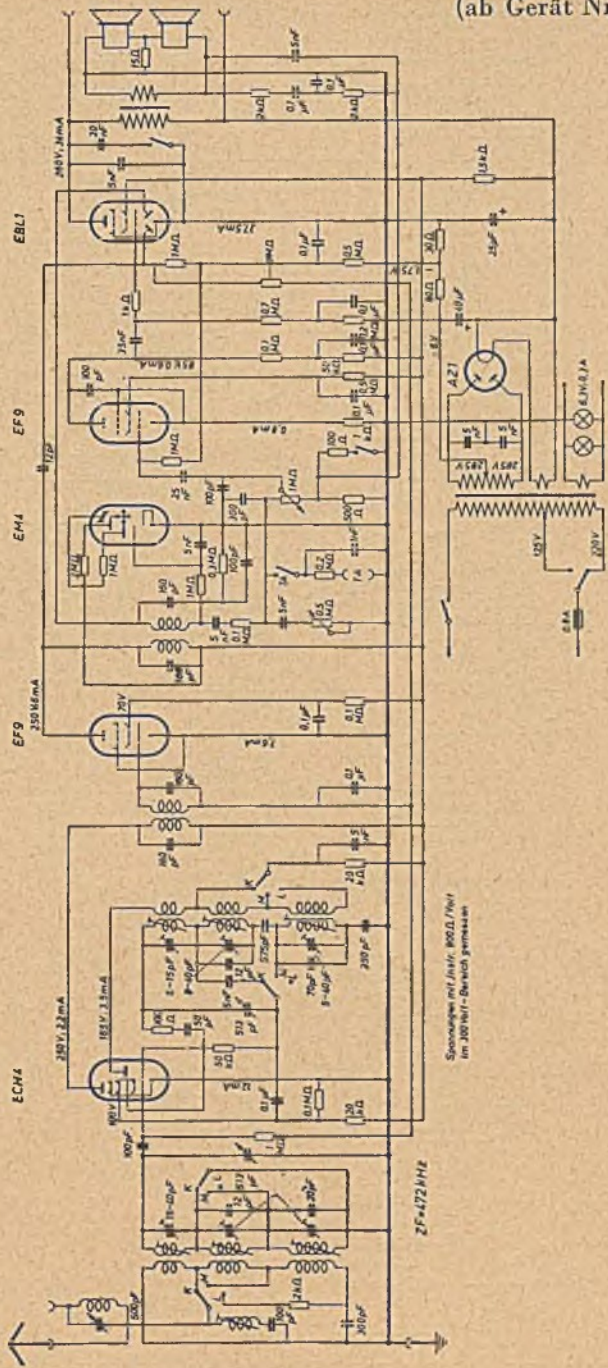

Continental Imperial 62 W

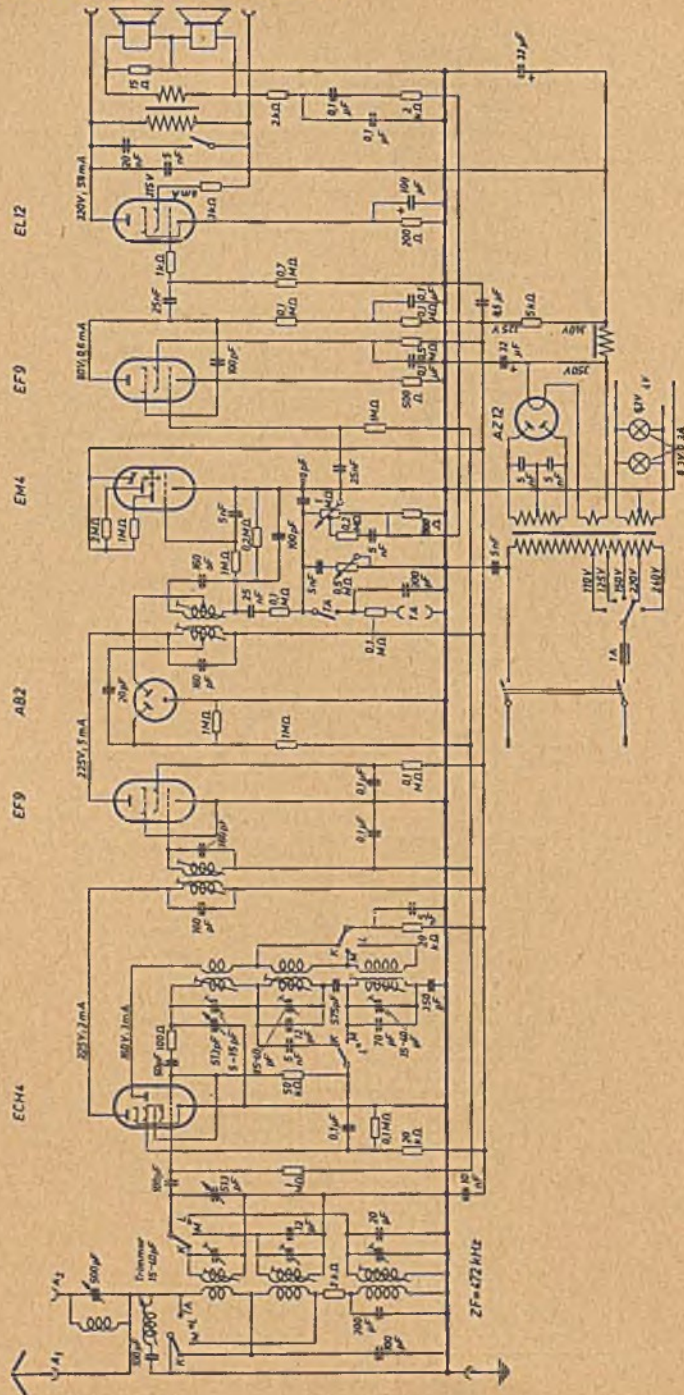

Continental Imperial 50 GW

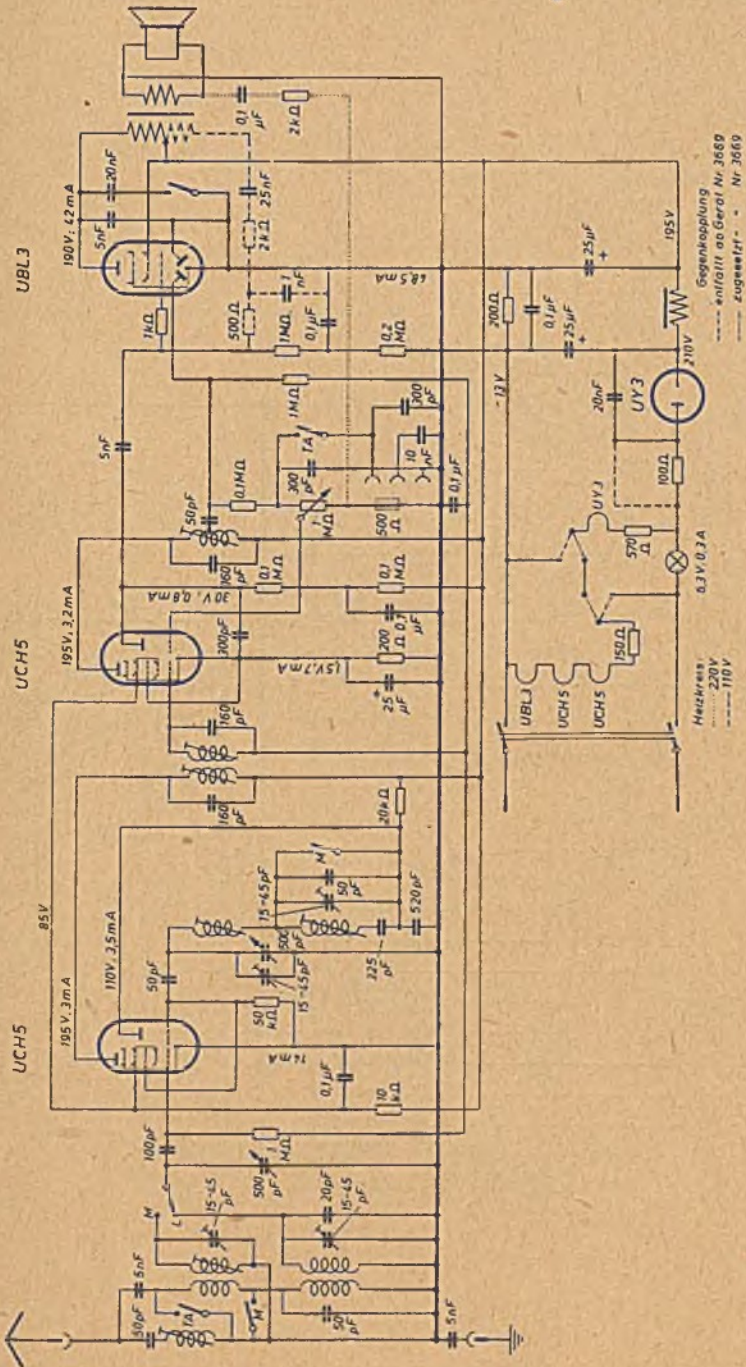

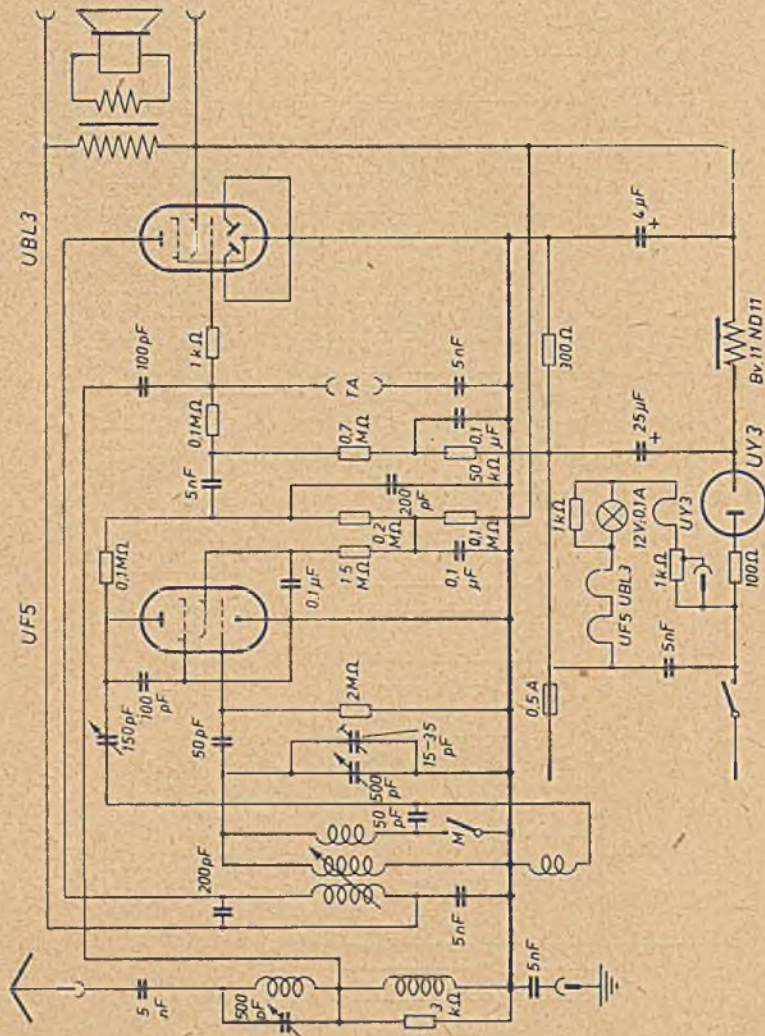

DTW
(Produktion nach 1945)

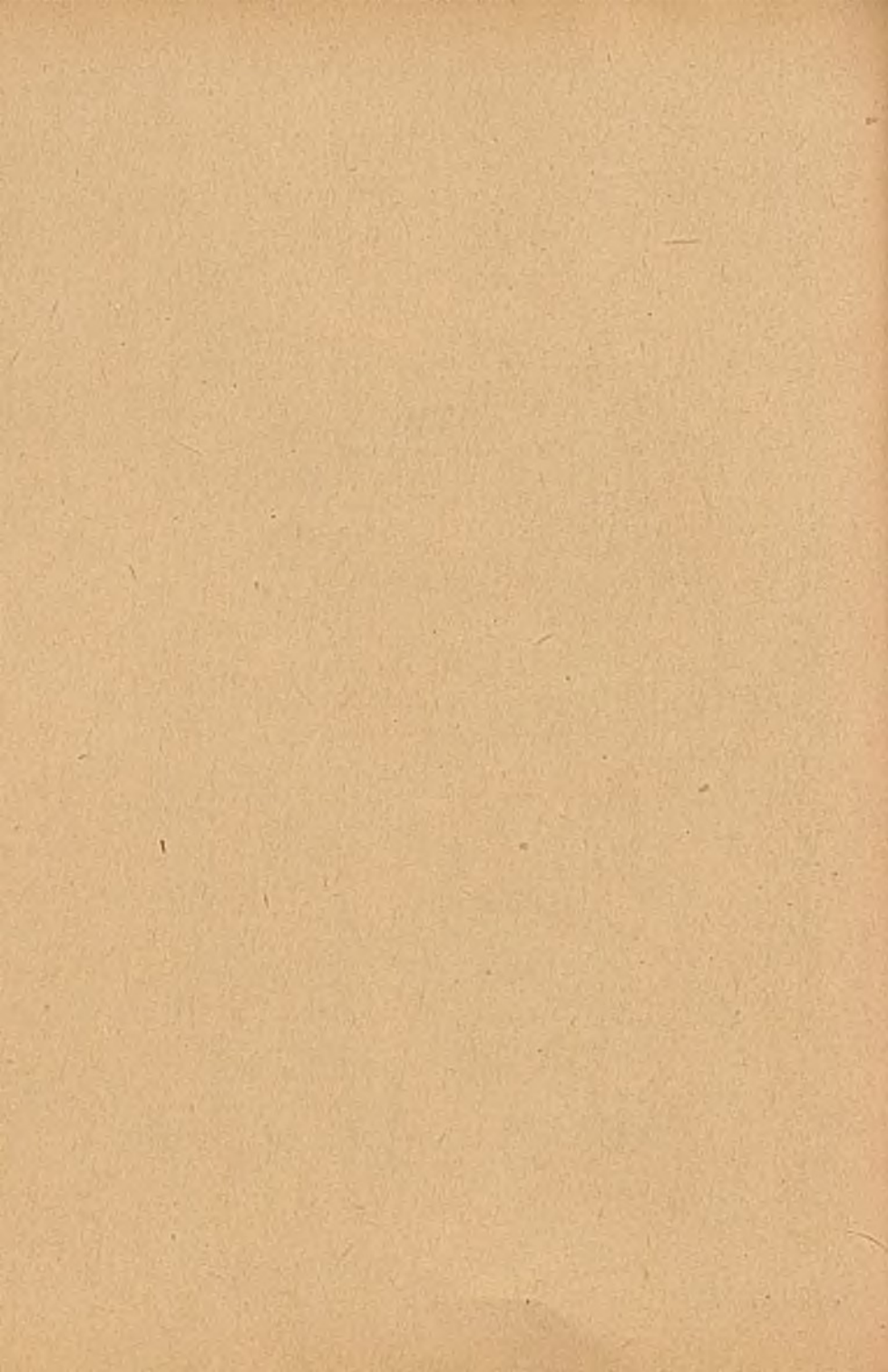

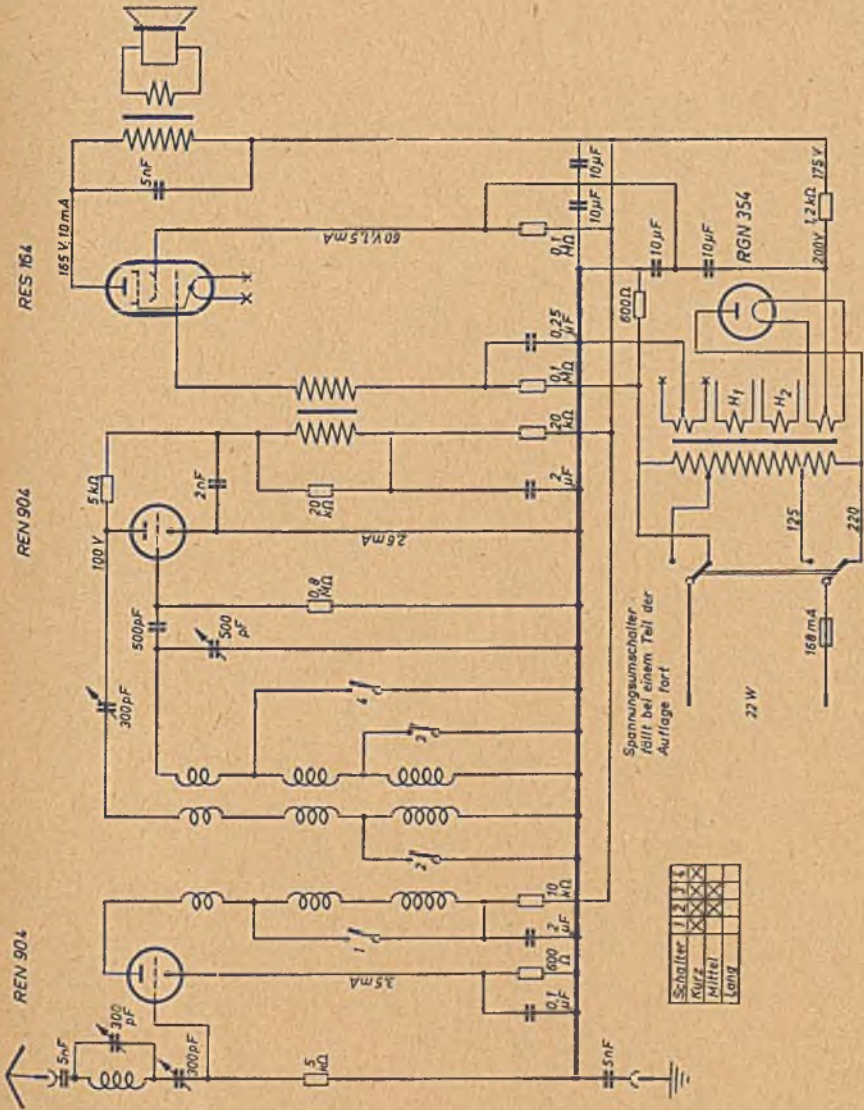

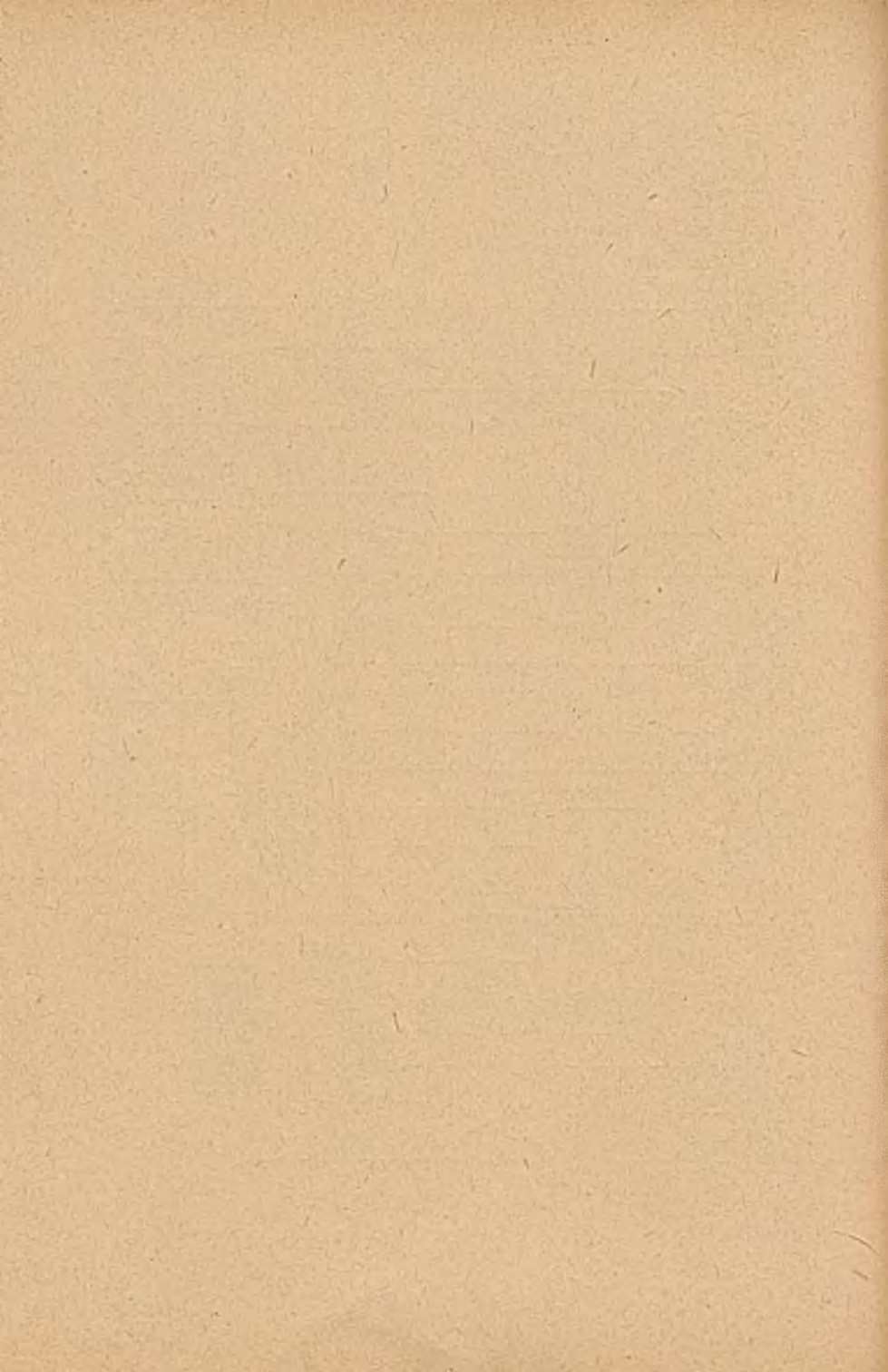

DTW
(Produktion vor 1945)



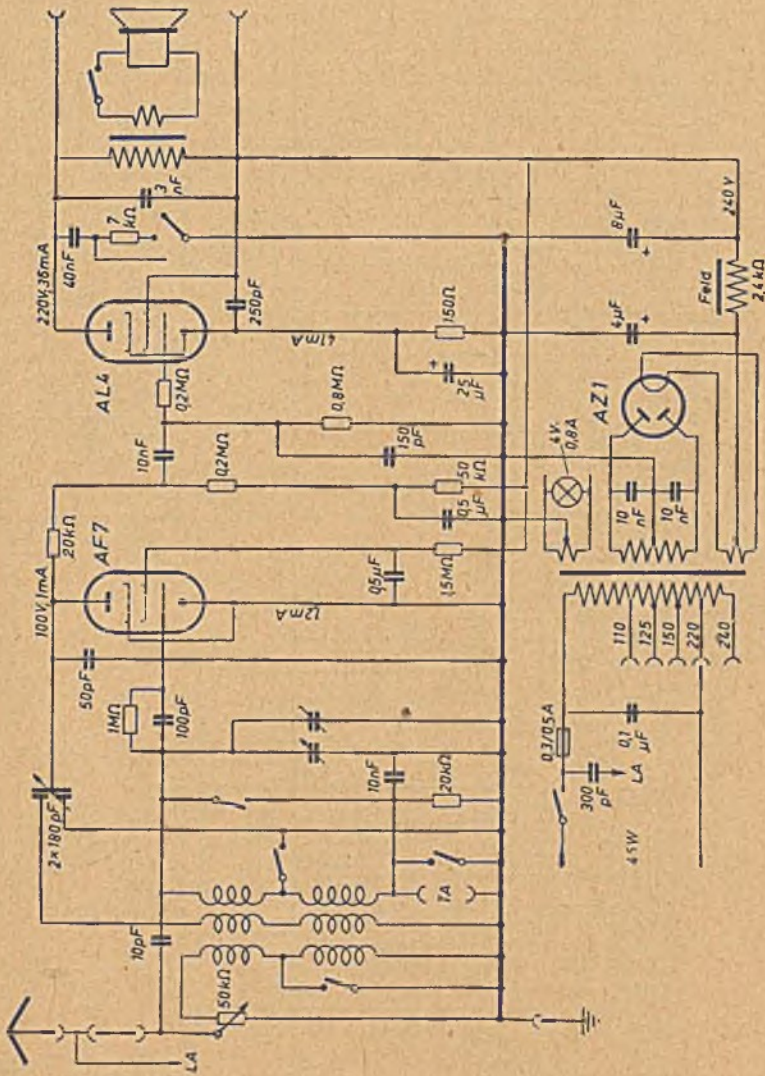

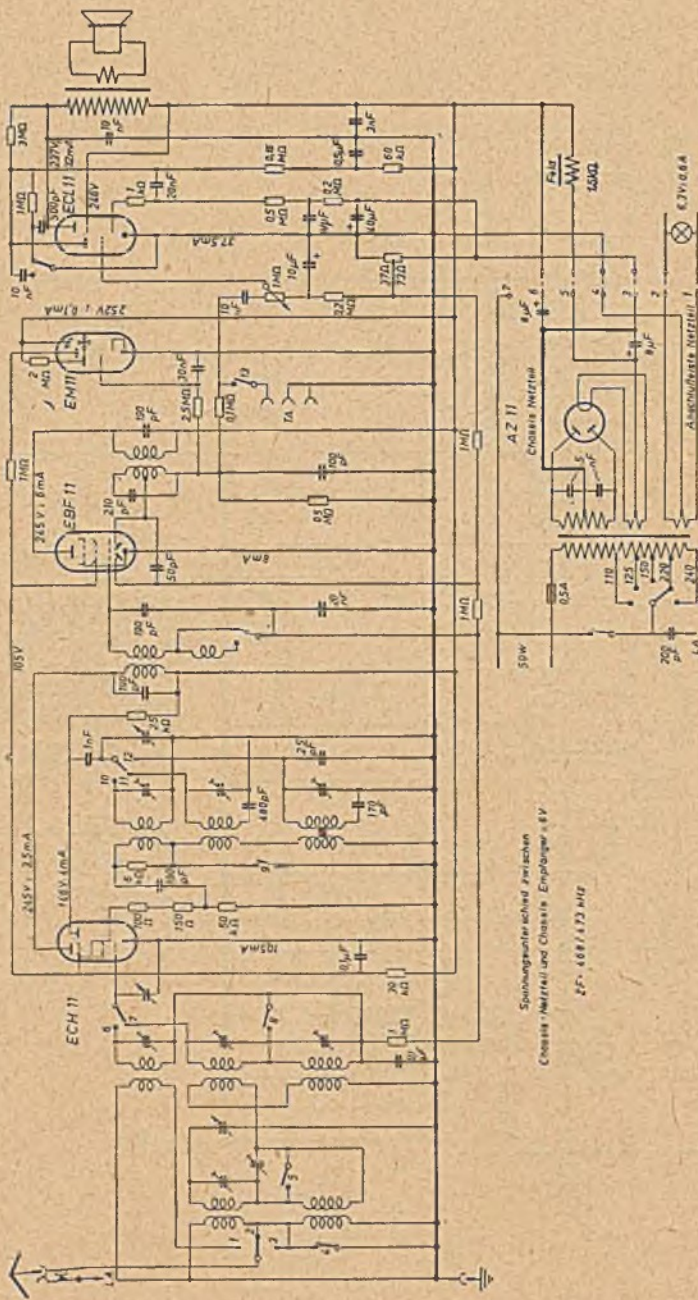

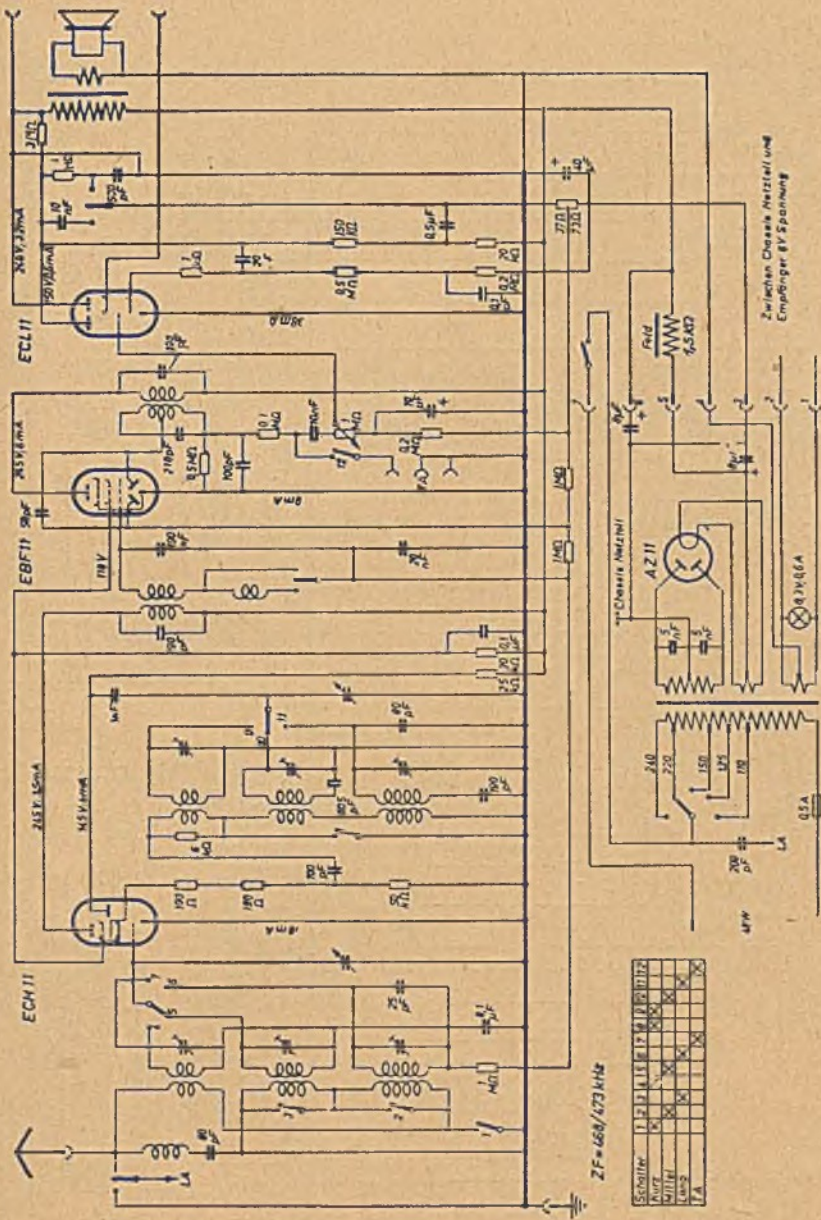

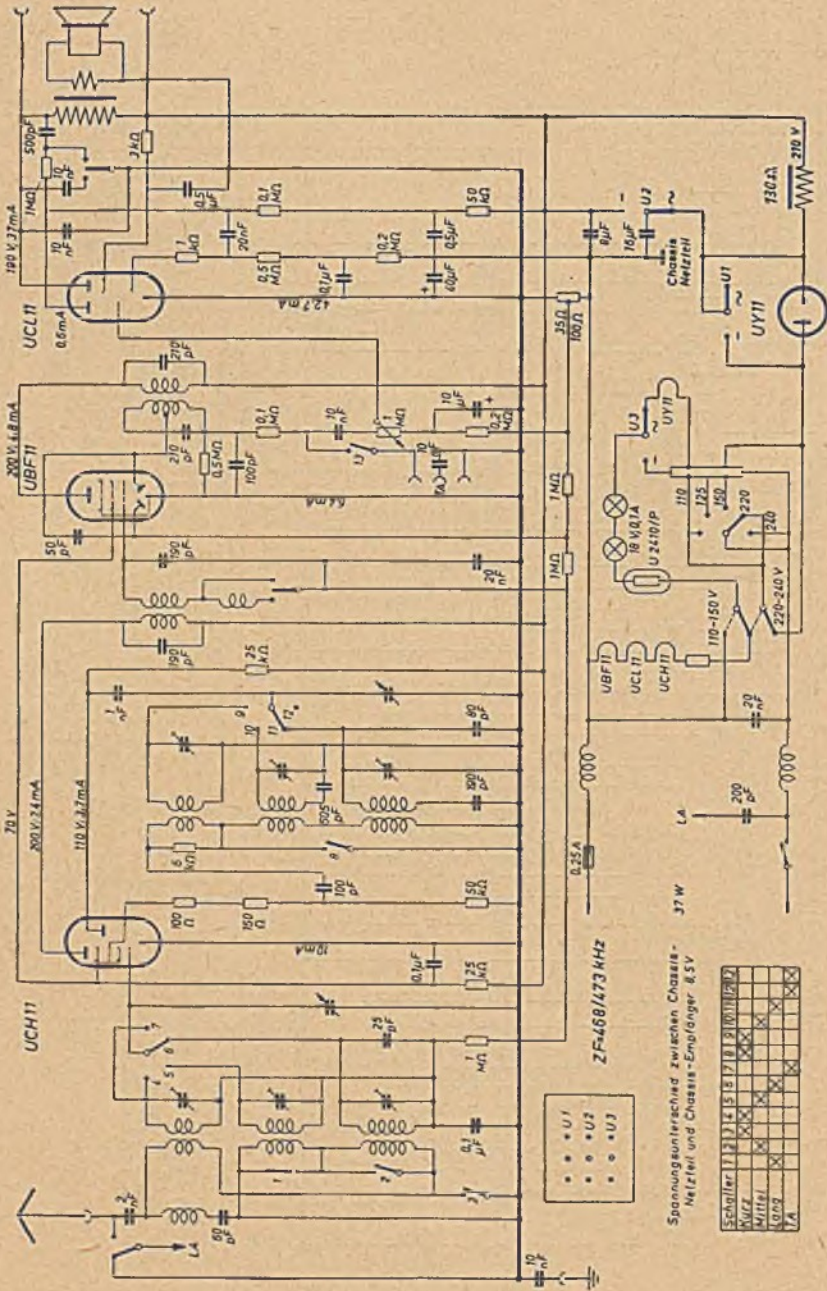

ZF=68/173 KHZ

Spannungsunterschied zwischen Chassis-Netzteil und Chassis-Empfänger 8.5V

Schalter	1	2	3	4	5	6	7	8	9	10	11	12	13	14	15	16	17	18	19	20	21	22	
Netzteil	X	X	X	X	X	X	X	X	X	X	X	X	X	X	X	X	X	X	X	X	X	X	X
Empfänger	X	X	X	X	X	X	X	X	X	X	X	X	X	X	X	X	X	X	X	X	X	X	X
L.A.	X	X	X	X	X	X	X	X	X	X	X	X	X	X	X	X	X	X	X	X	X	X	X

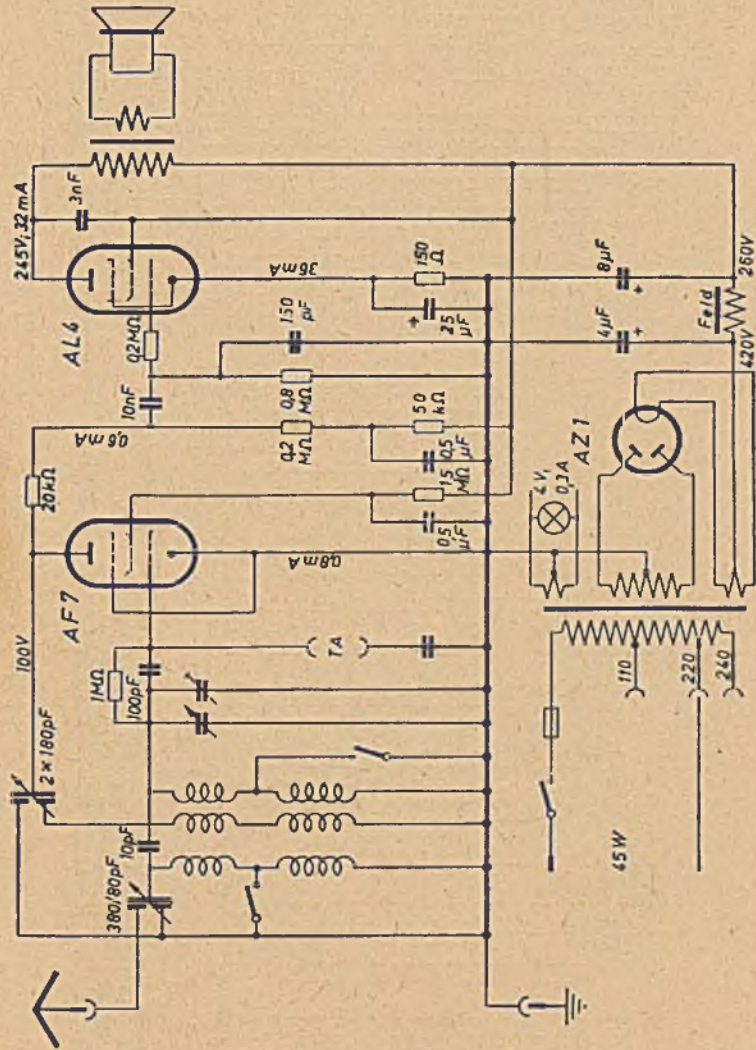

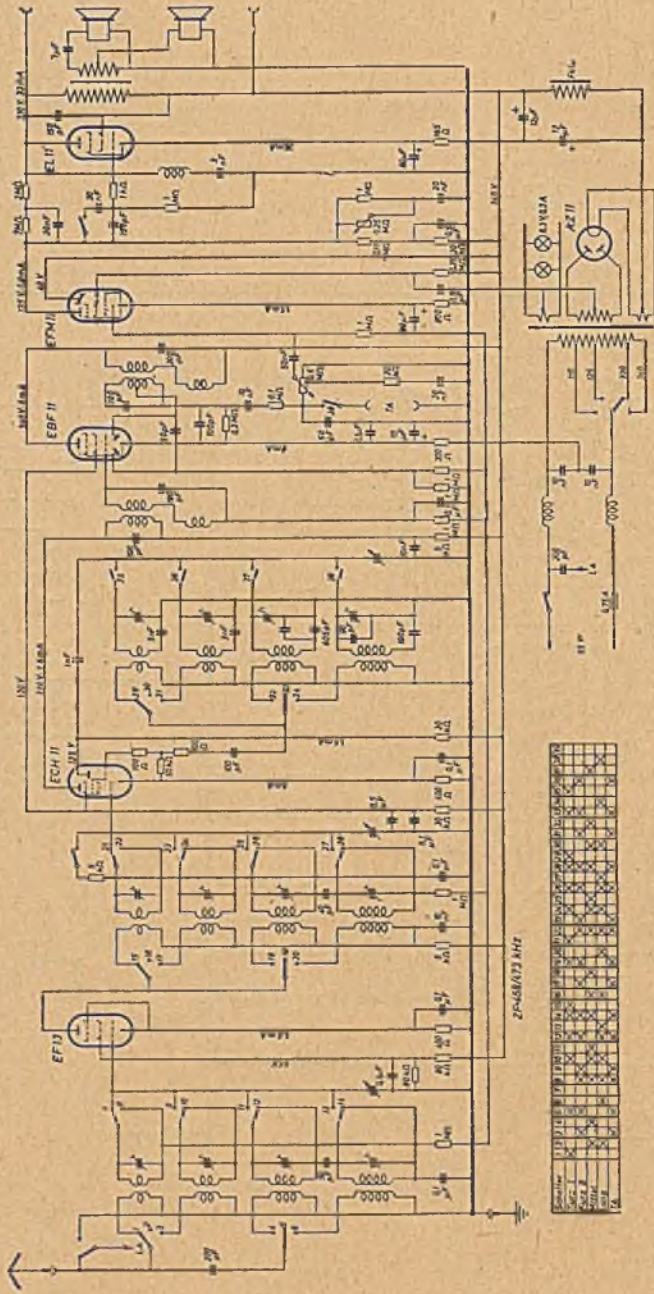

Component	Value
1	100K
2	100K
3	100K
4	100K
5	100K
6	100K
7	100K
8	100K
9	100K
10	100K
11	100K
12	100K
13	100K
14	100K
15	100K
16	100K
17	100K
18	100K
19	100K
20	100K
21	100K
22	100K
23	100K
24	100K
25	100K
26	100K
27	100K
28	100K
29	100K
30	100K
31	100K
32	100K
33	100K
34	100K
35	100K
36	100K
37	100K
38	100K
39	100K
40	100K
41	100K
42	100K
43	100K
44	100K
45	100K
46	100K
47	100K
48	100K
49	100K
50	100K
51	100K
52	100K
53	100K
54	100K
55	100K
56	100K
57	100K
58	100K
59	100K
60	100K
61	100K
62	100K
63	100K
64	100K
65	100K
66	100K
67	100K
68	100K
69	100K
70	100K
71	100K
72	100K
73	100K
74	100K
75	100K
76	100K
77	100K
78	100K
79	100K
80	100K
81	100K
82	100K
83	100K
84	100K
85	100K
86	100K
87	100K
88	100K
89	100K
90	100K
91	100K
92	100K
93	100K
94	100K
95	100K
96	100K
97	100K
98	100K
99	100K
100	100K

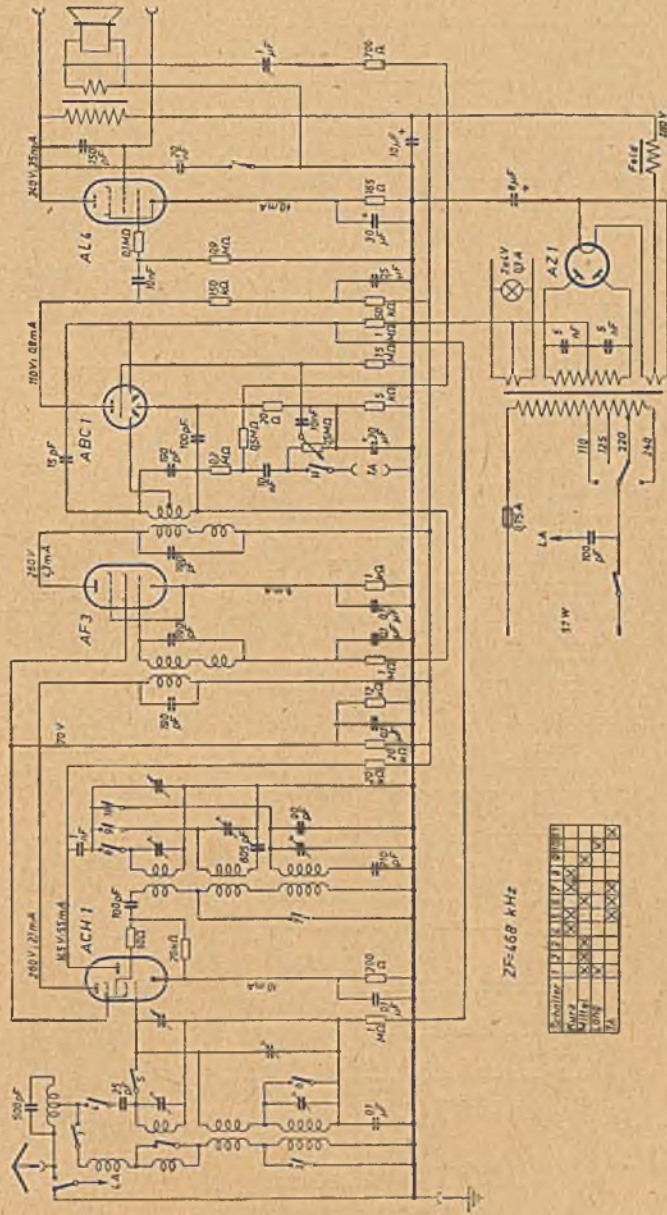

ZF=468 kHz

Scale	1	2	3	4	5	6	7	8	9	10
Scale	1	2	3	4	5	6	7	8	9	10
Value	1	2	3	4	5	6	7	8	9	10
Unit	1	2	3	4	5	6	7	8	9	10

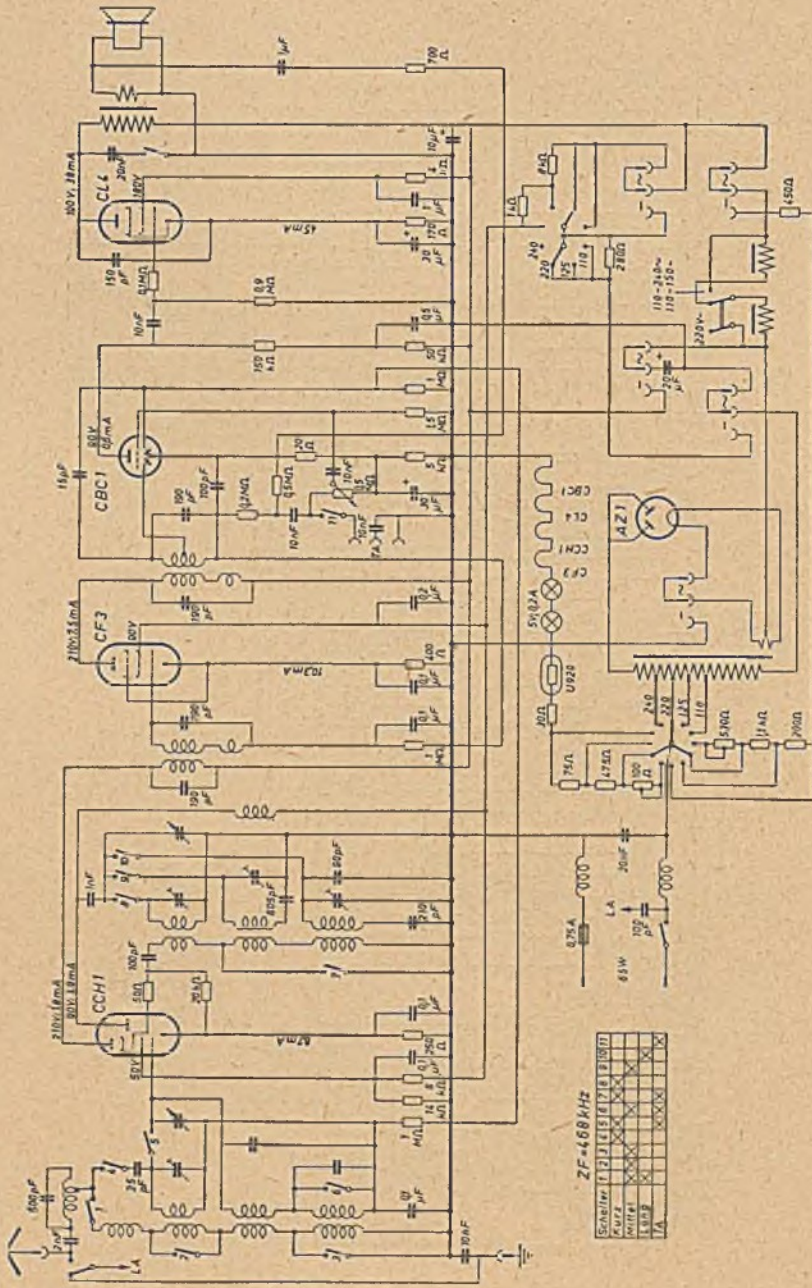

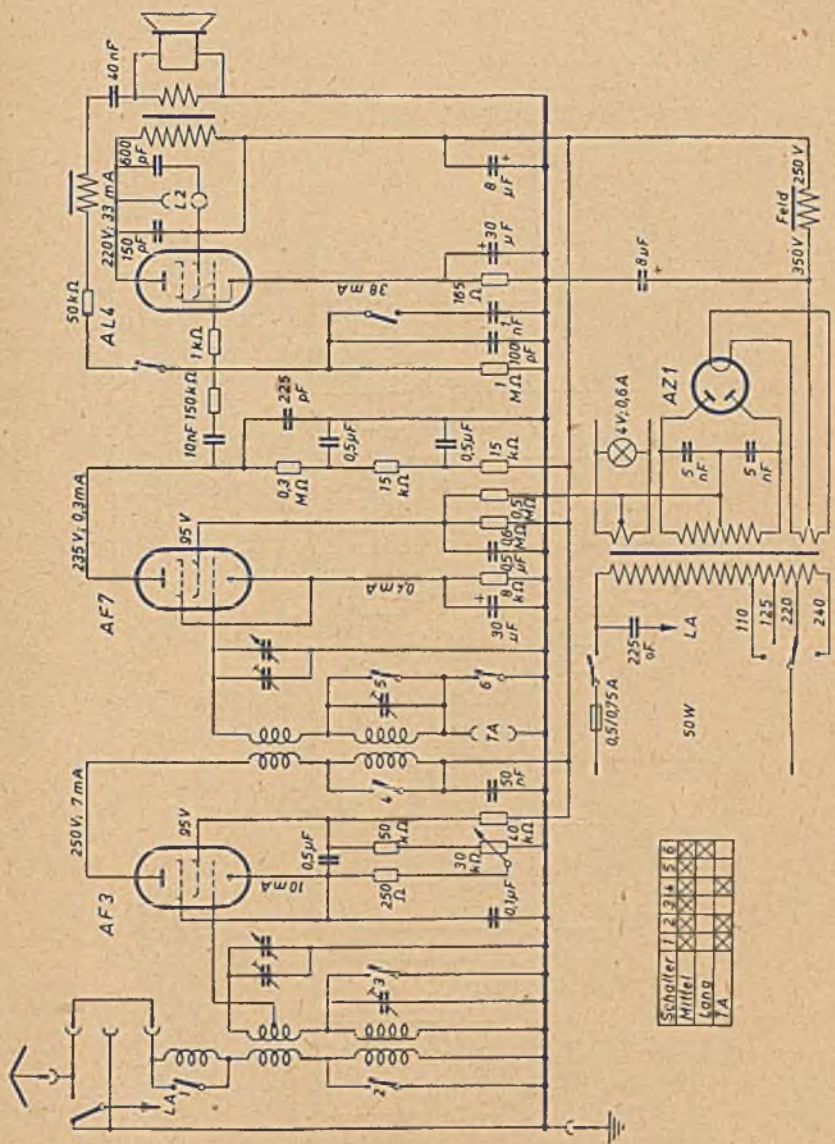

Schaller	1	2	3	1	3	1	6
Mittel							
Land							
YA							

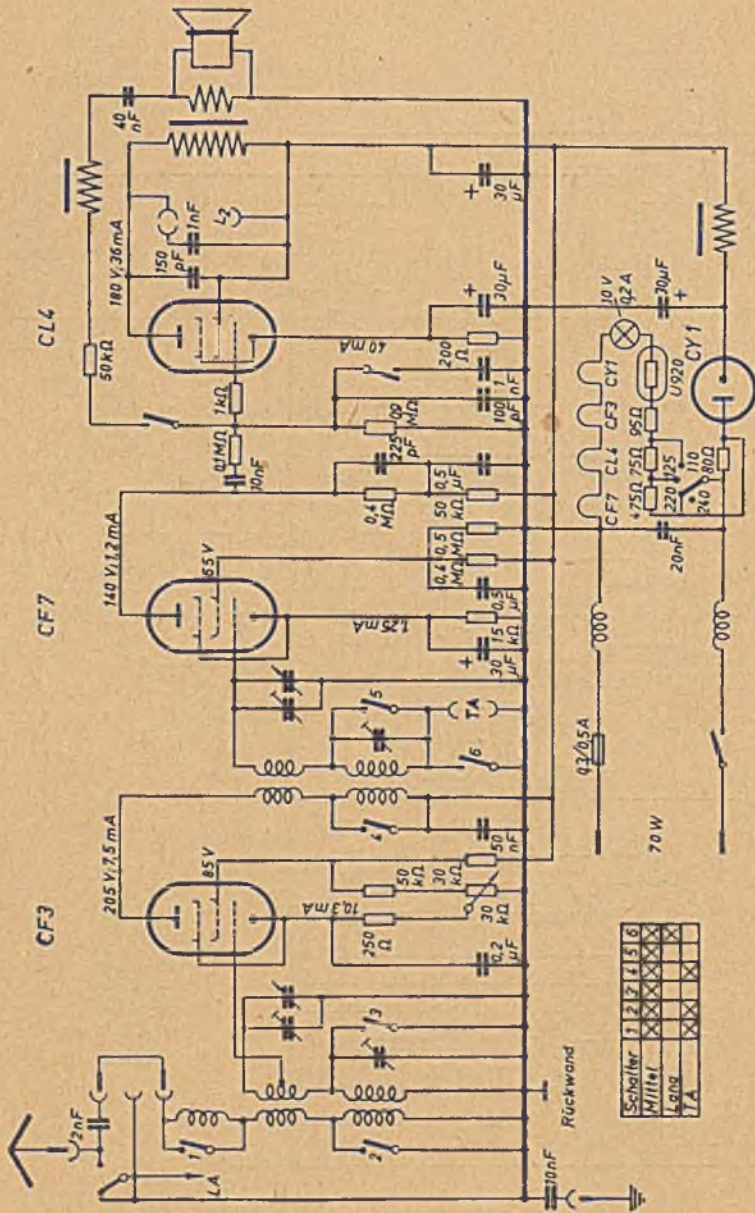

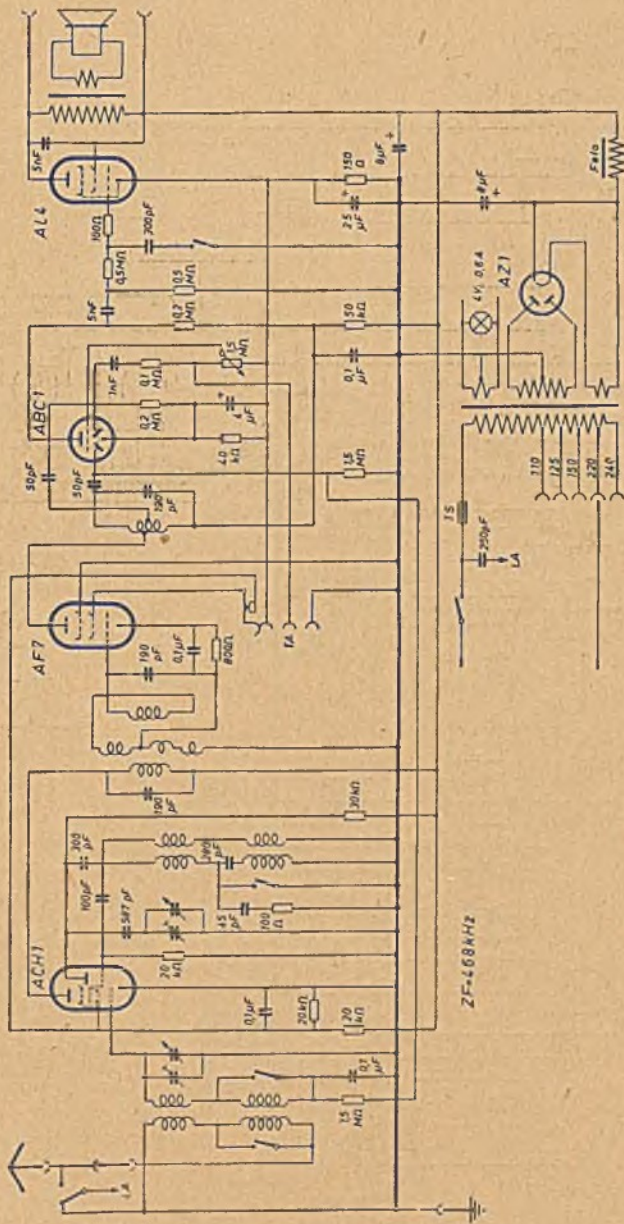

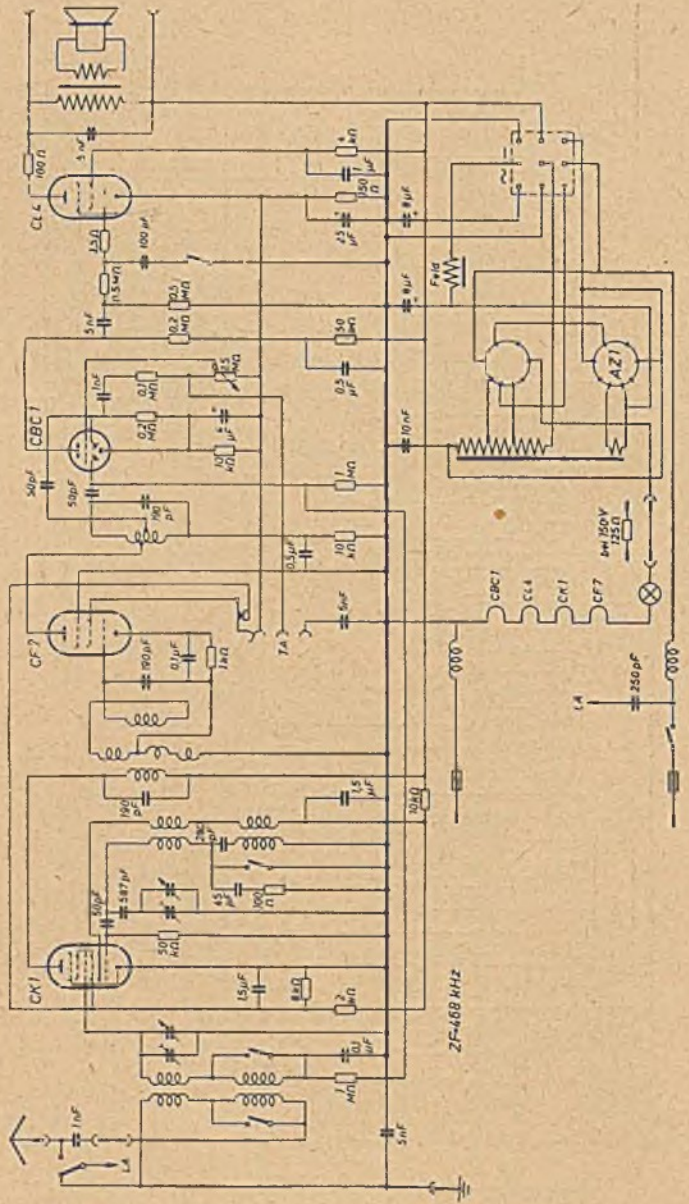

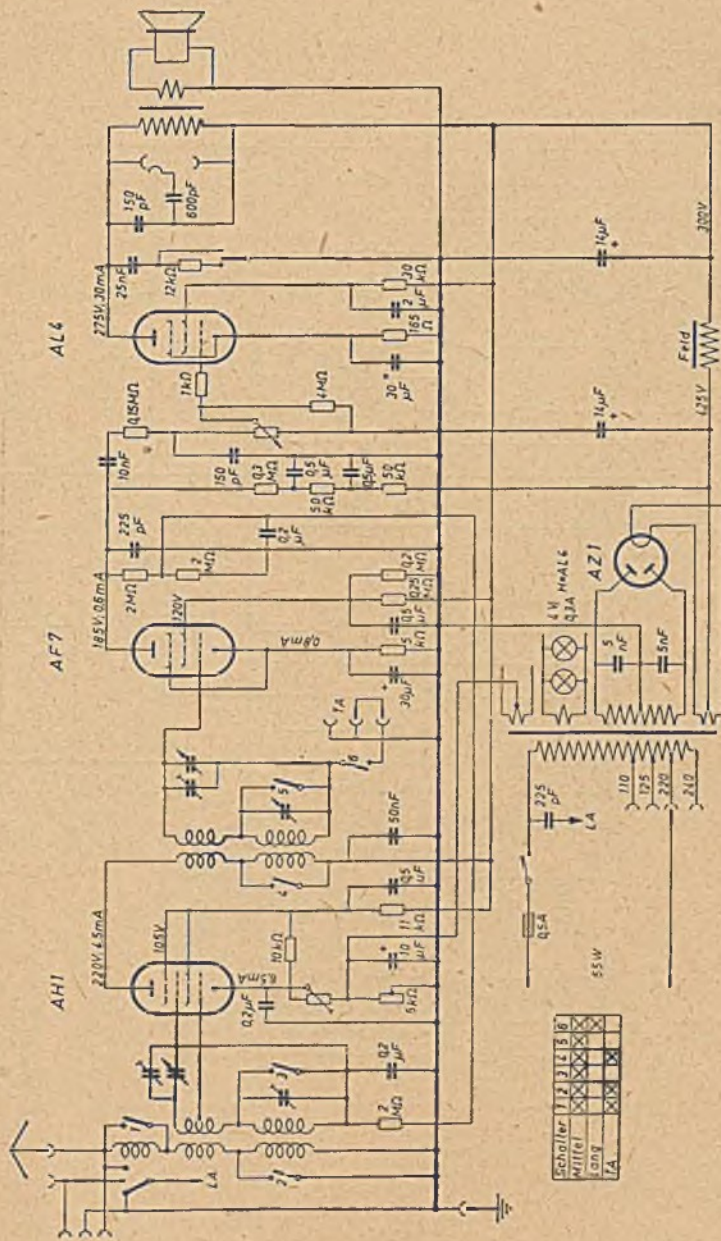

Schalter	1	2	3	4	5	6
Mitte	X	X	X	X	X	X
Lang	X	X	X	X	X	X
LA	X	X	X	X	X	X

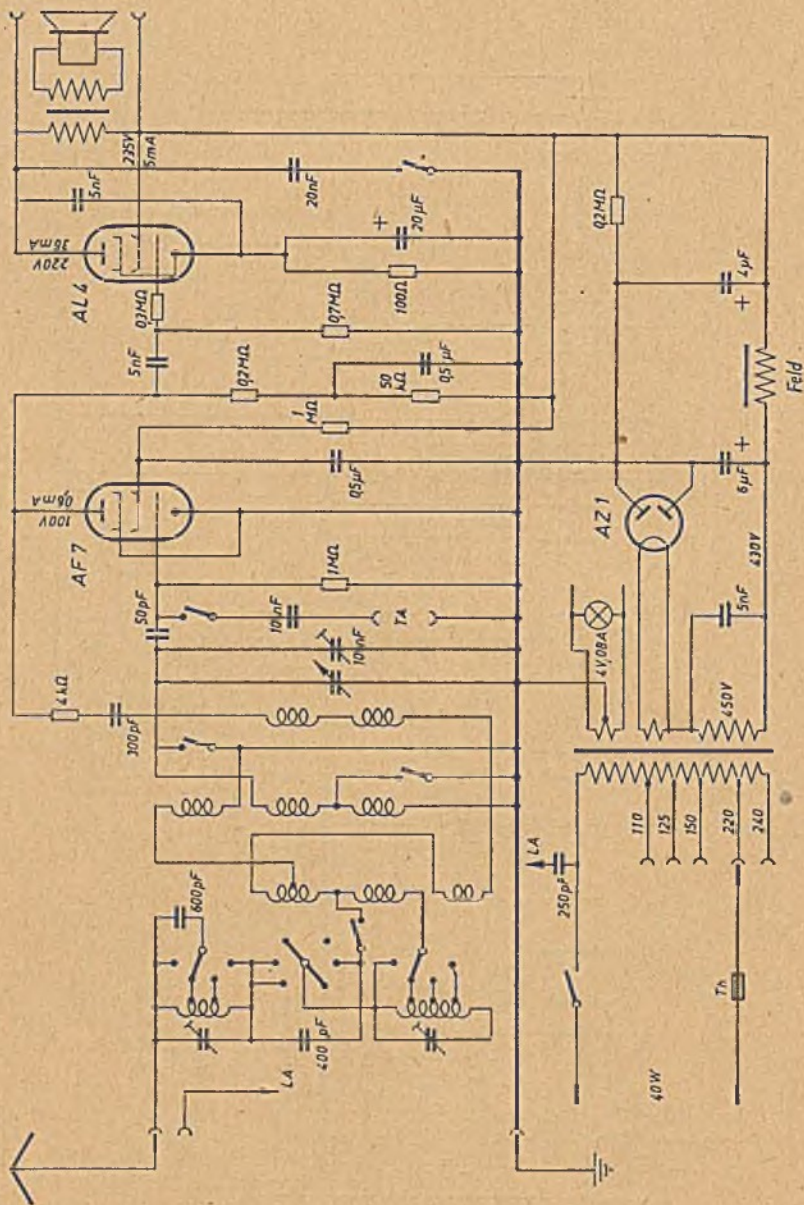

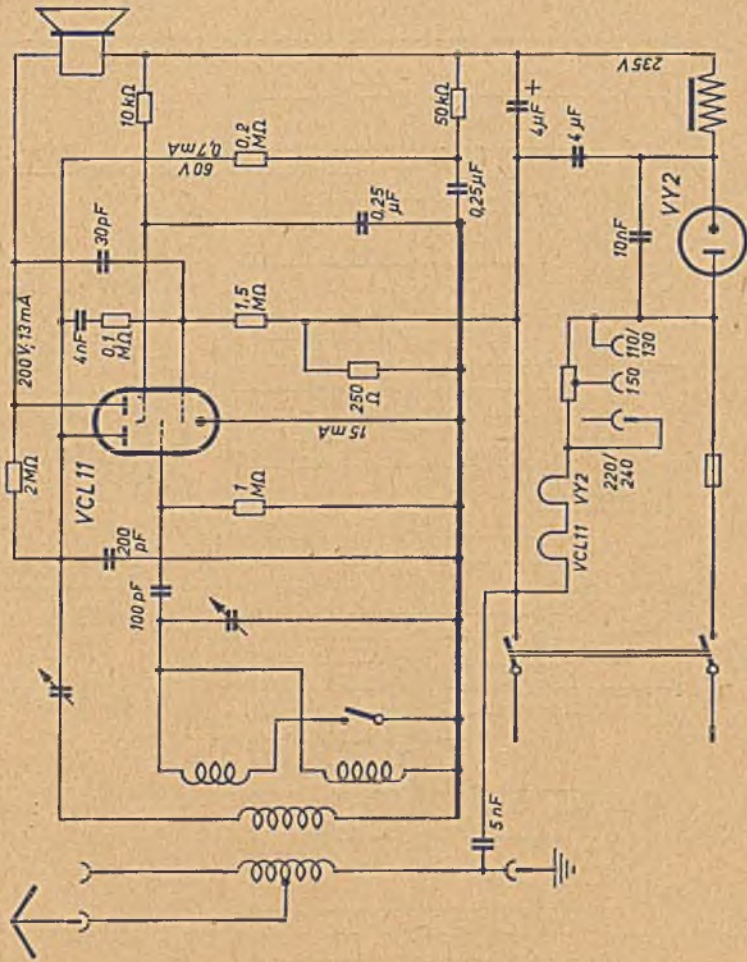

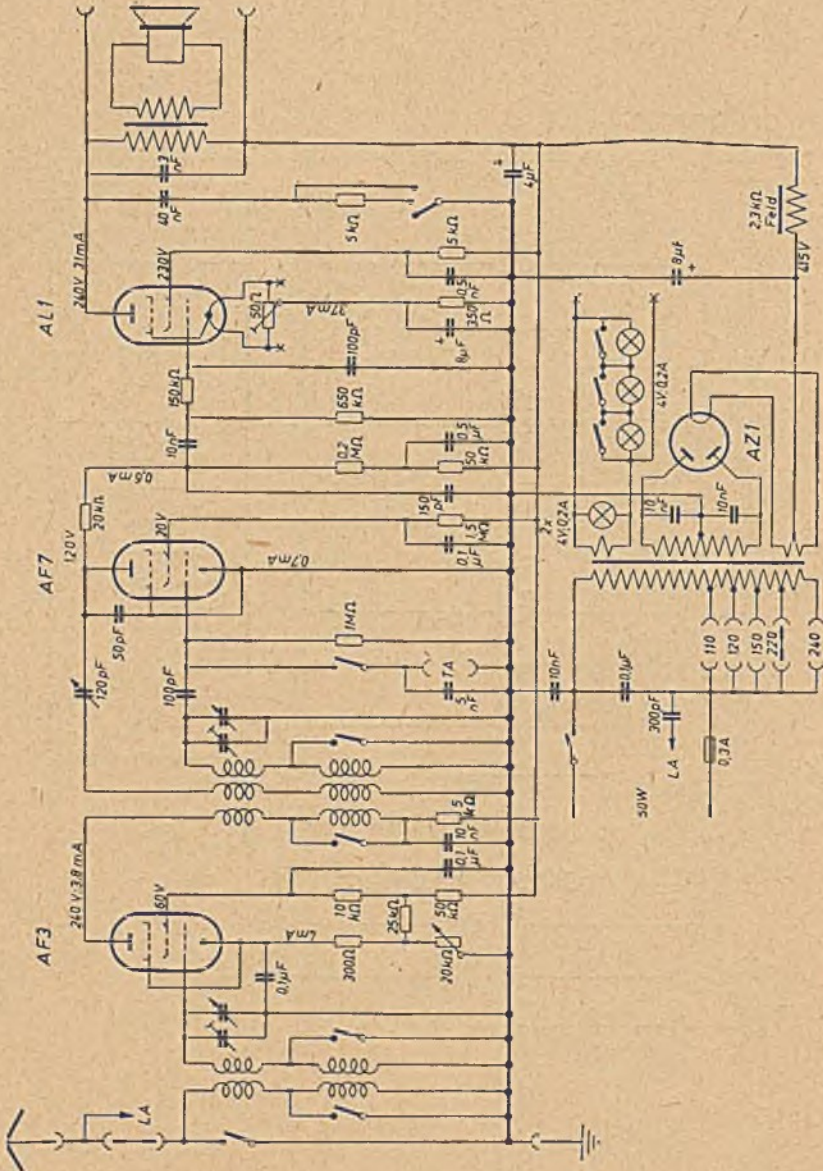

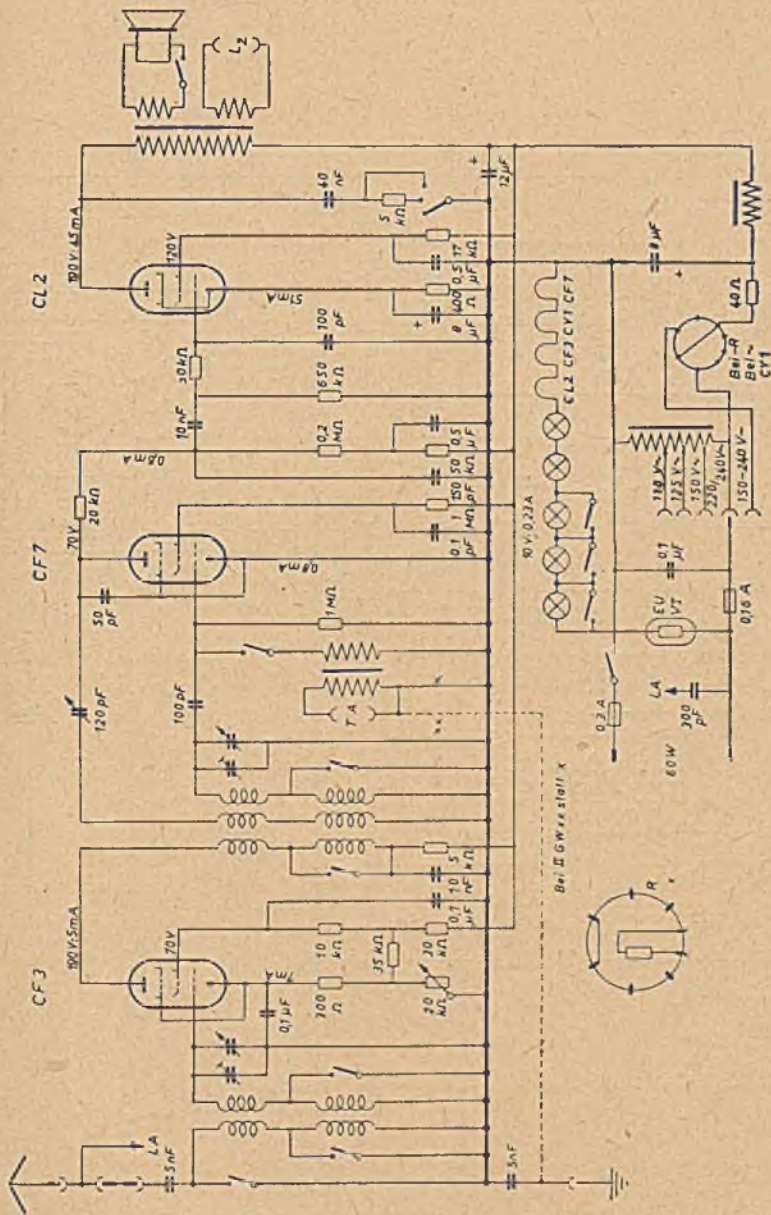

RES 164

AF 7

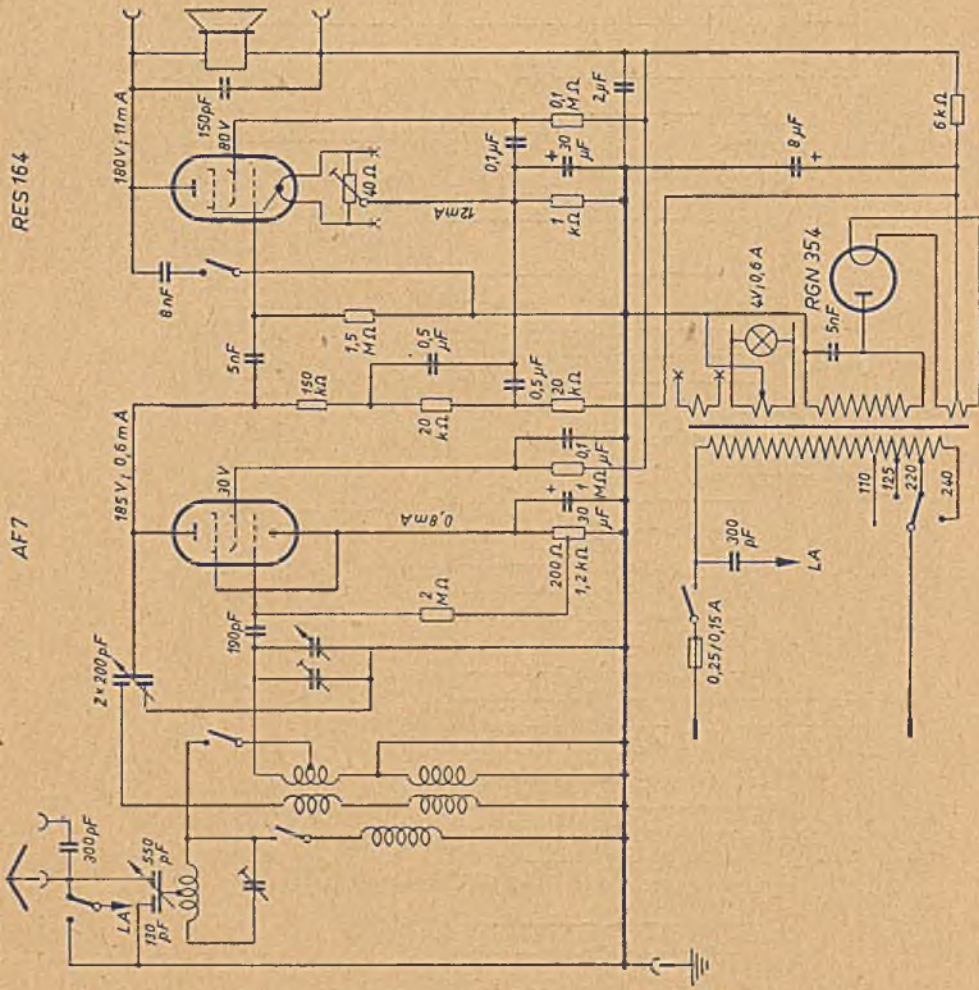

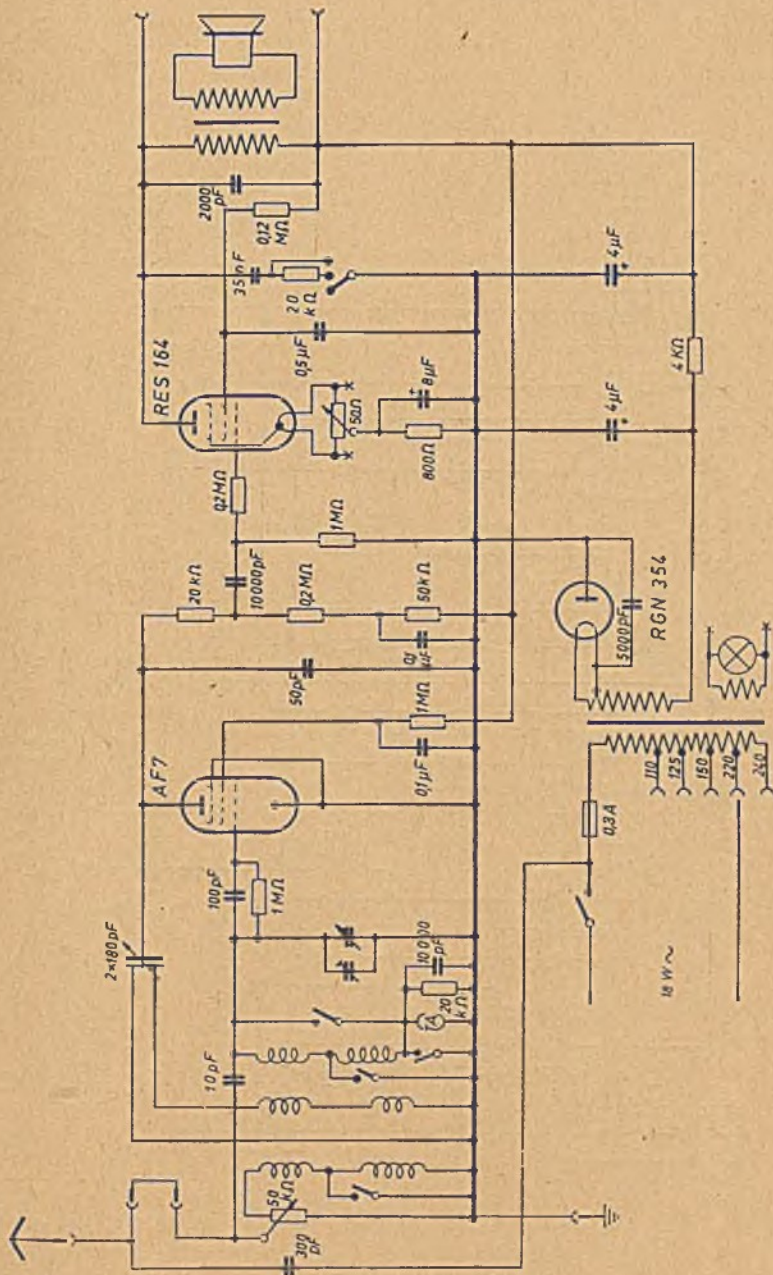

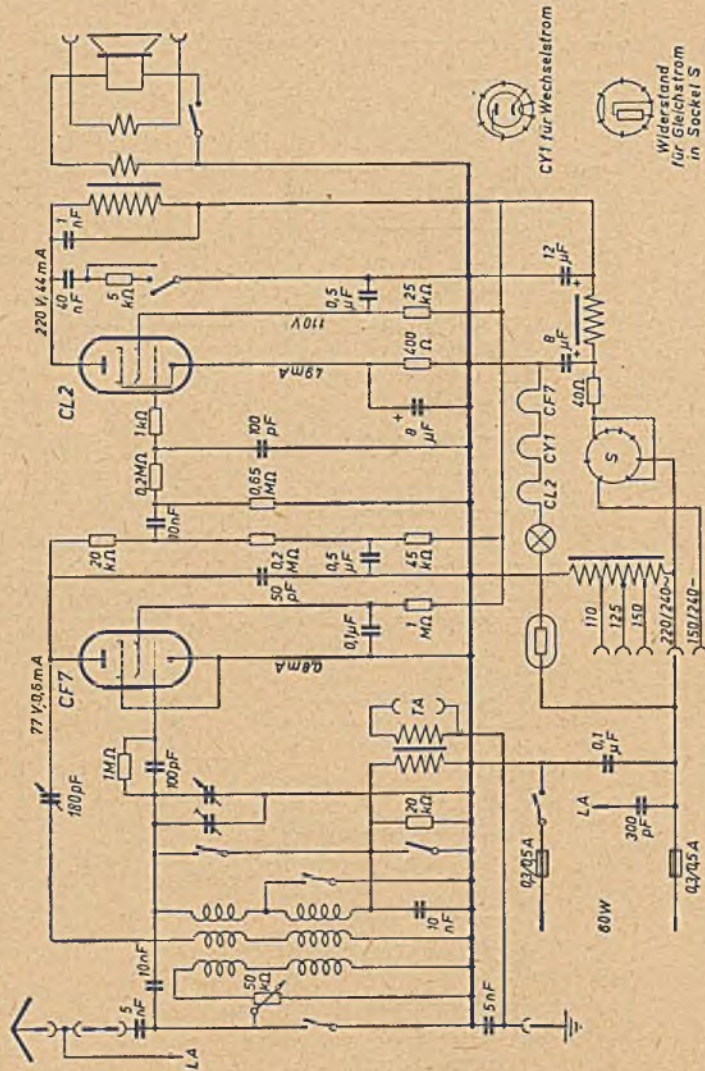

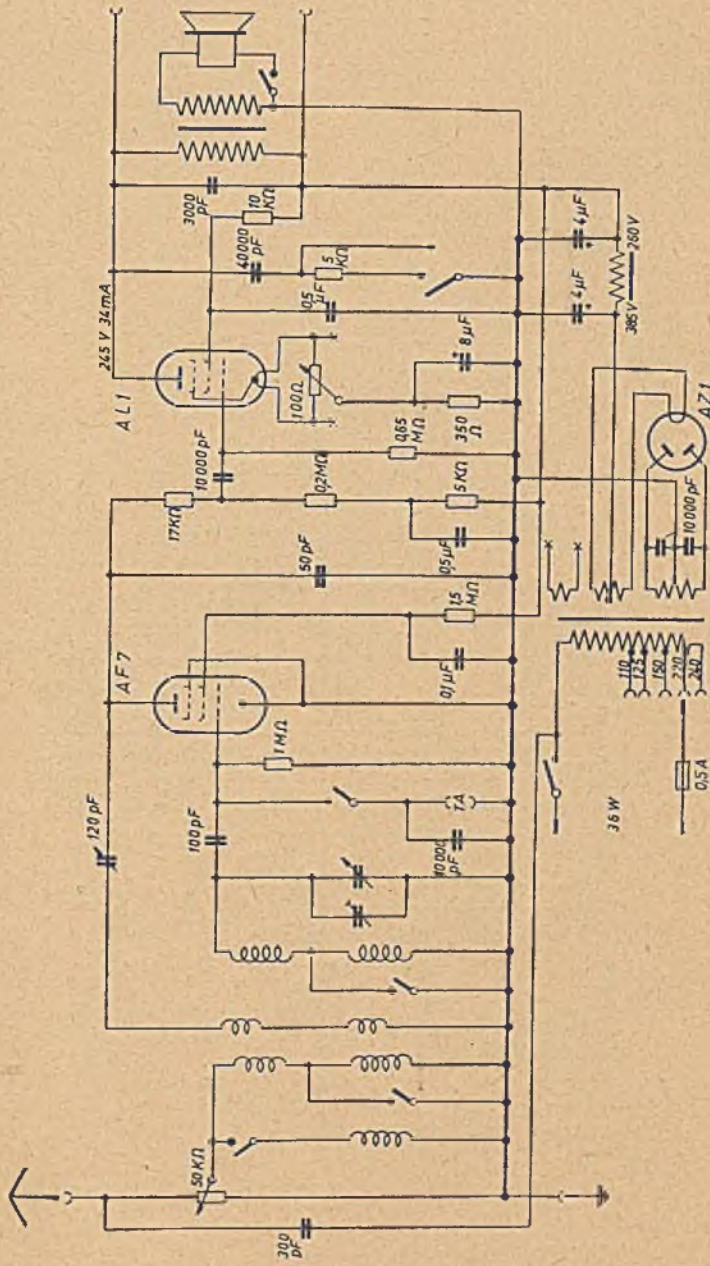

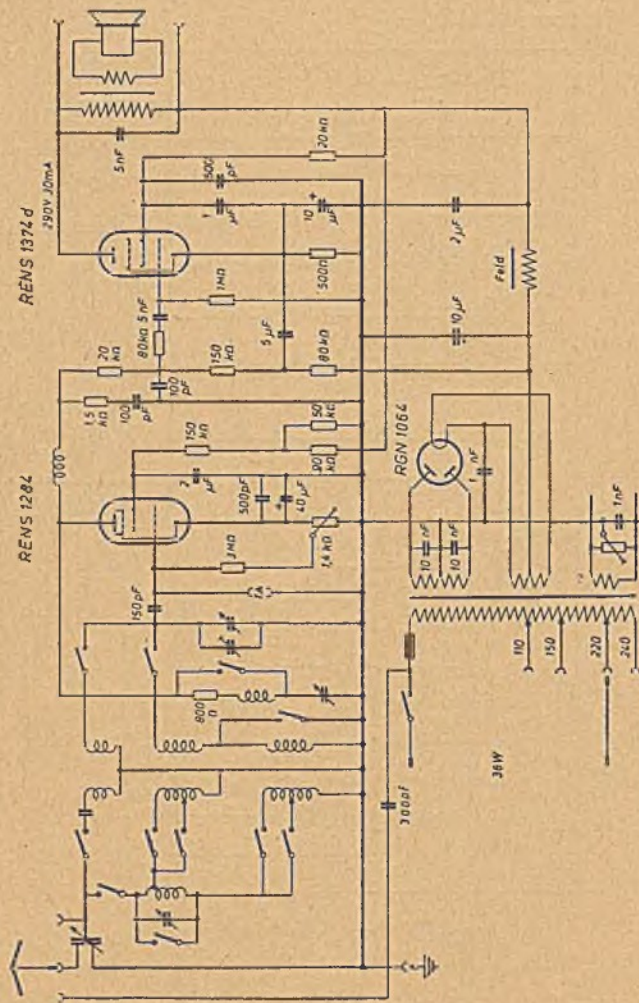

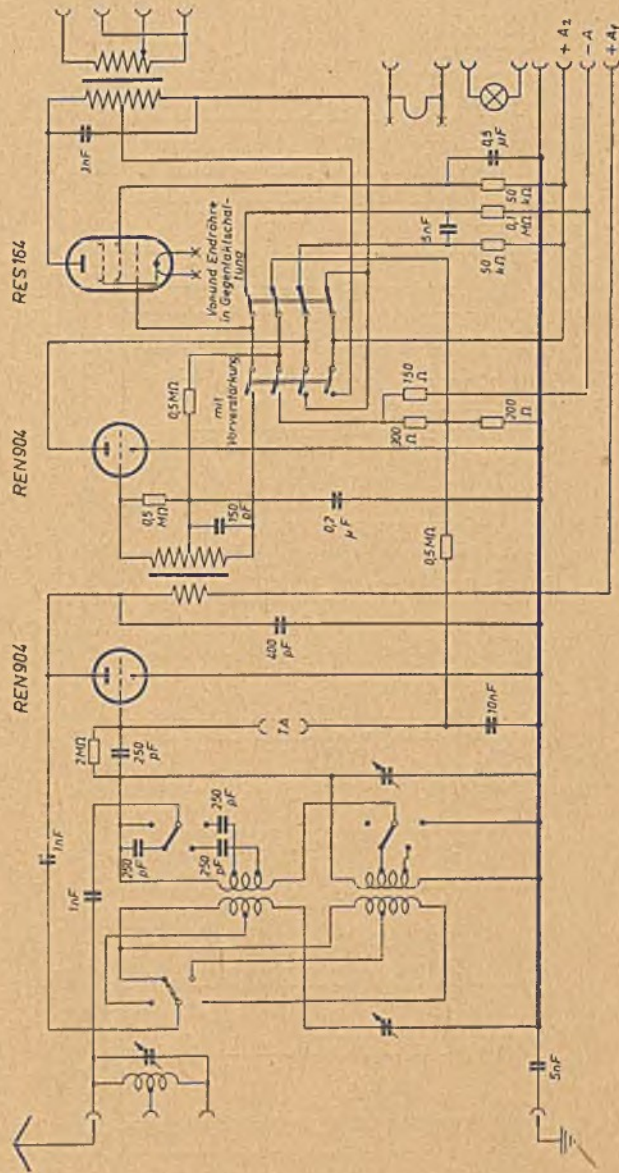

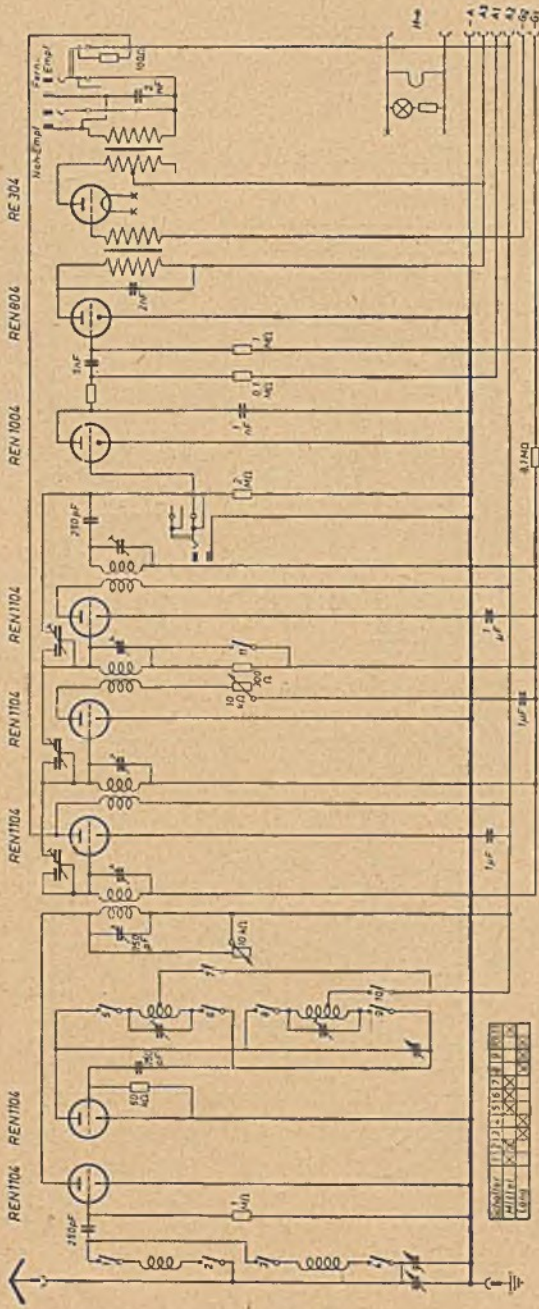

ELBEG



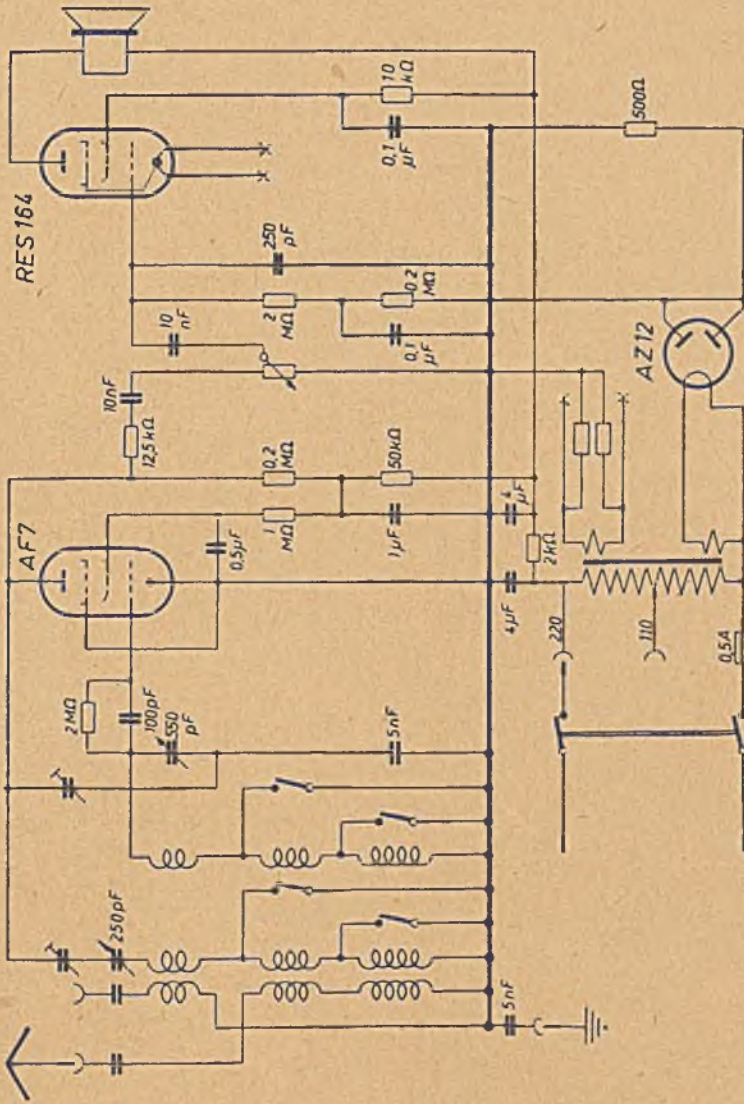



ELBIA



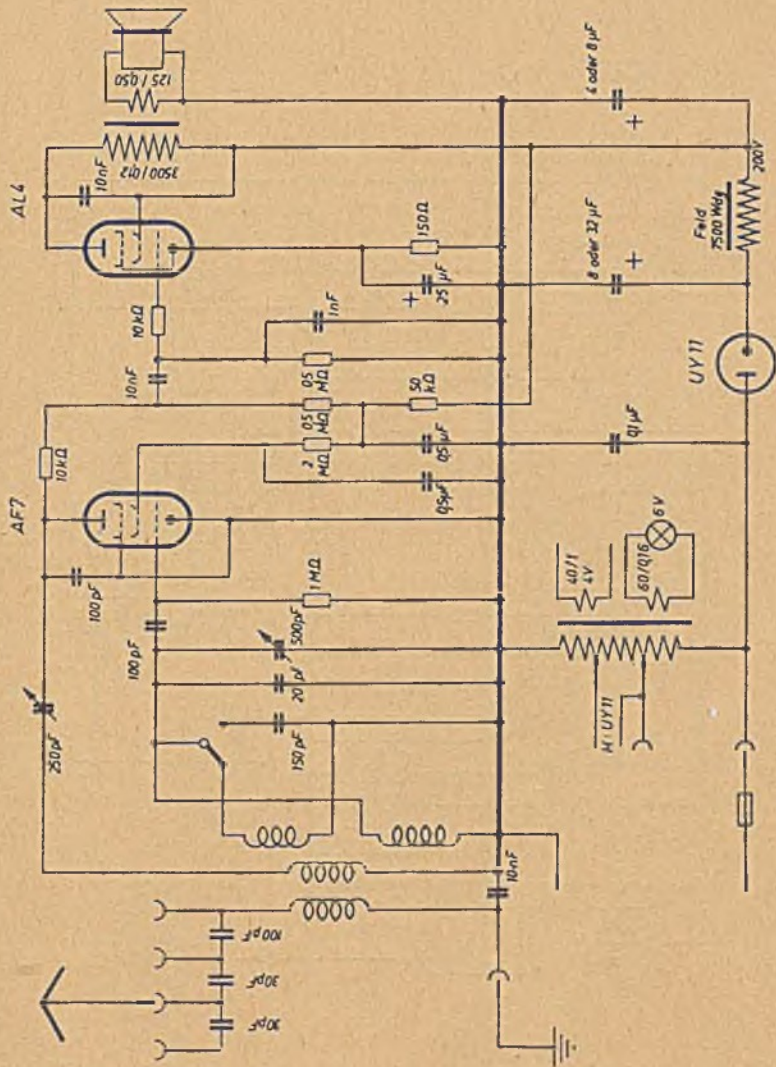

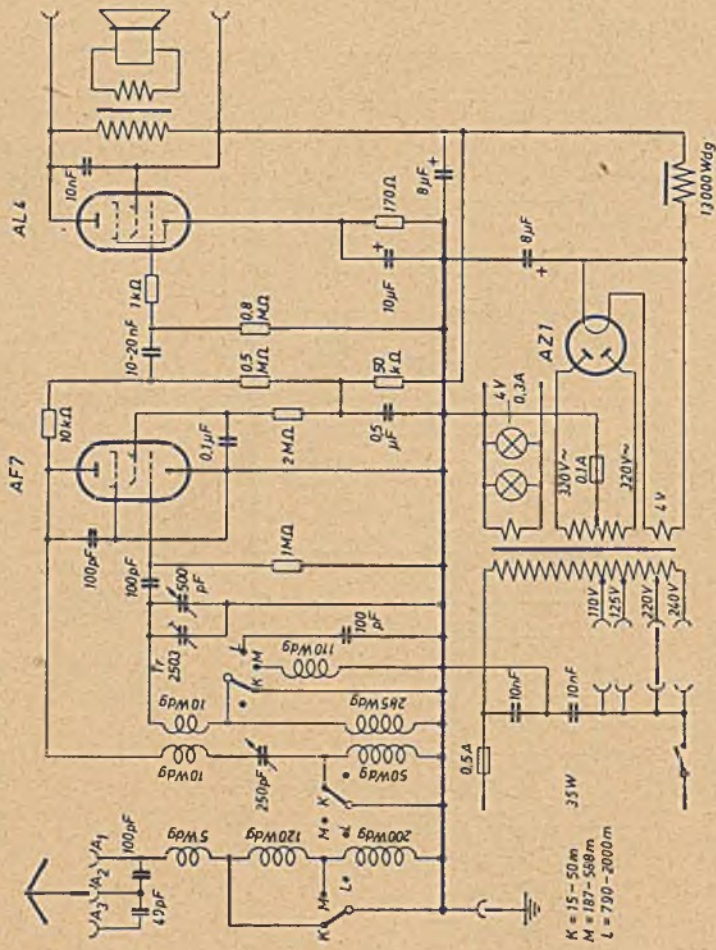

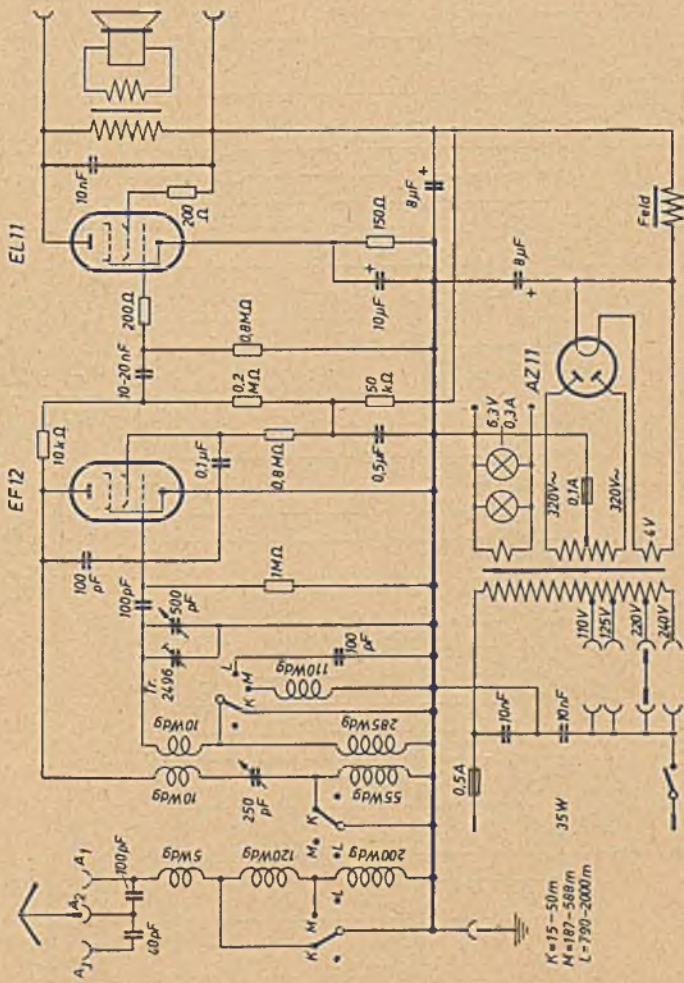

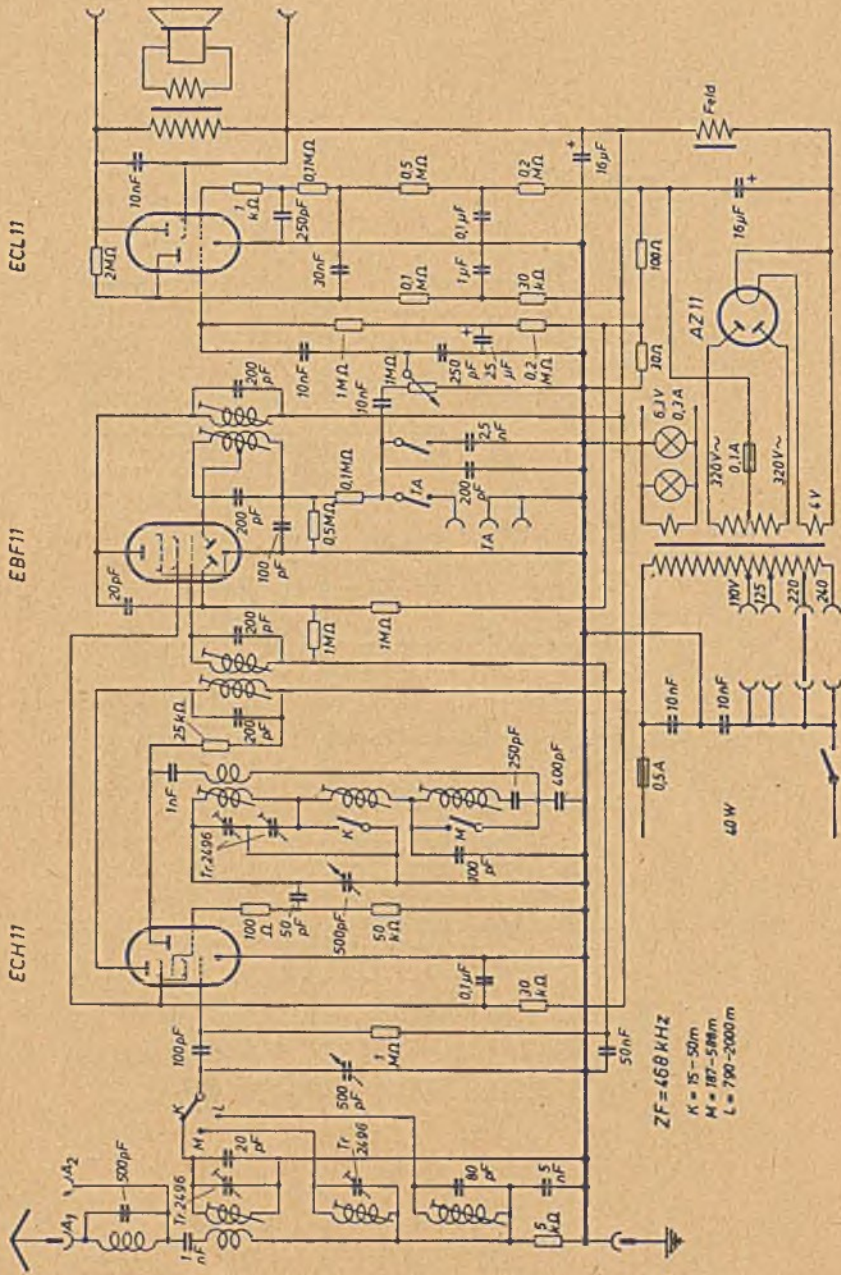

ELCOPHON



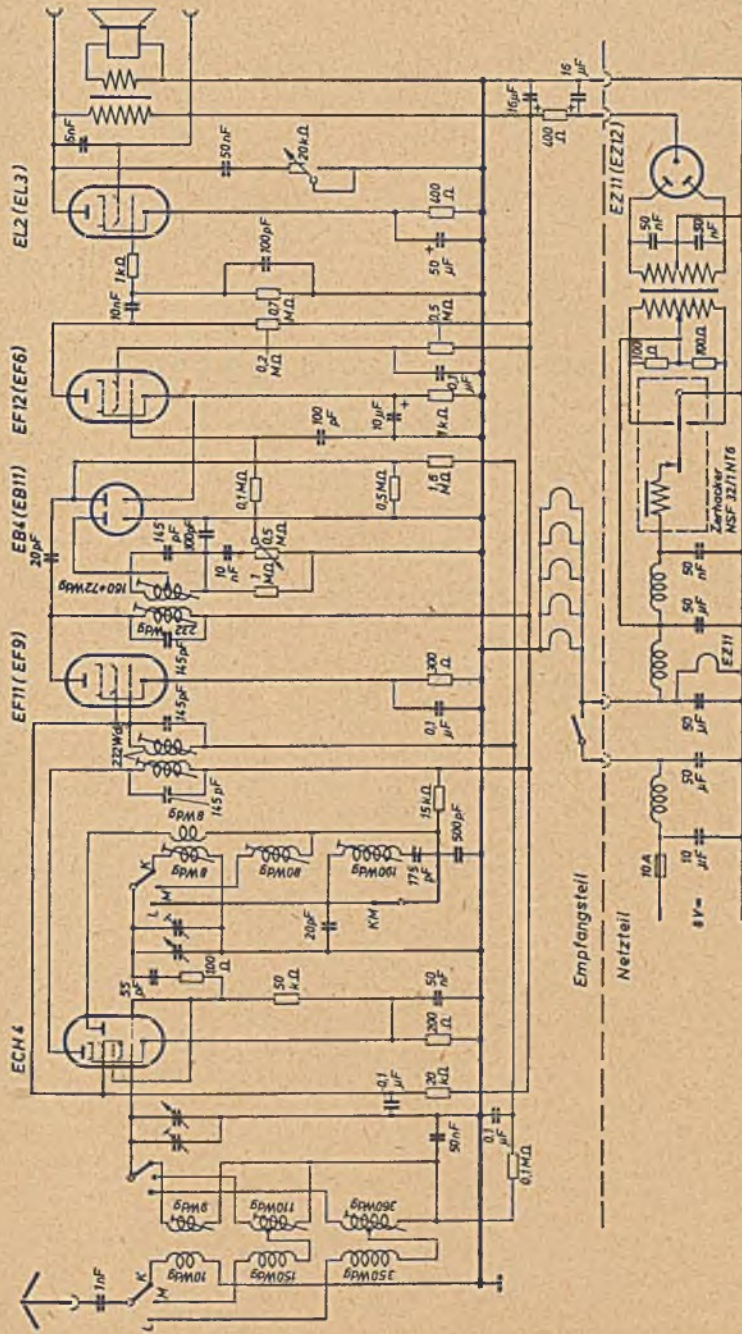

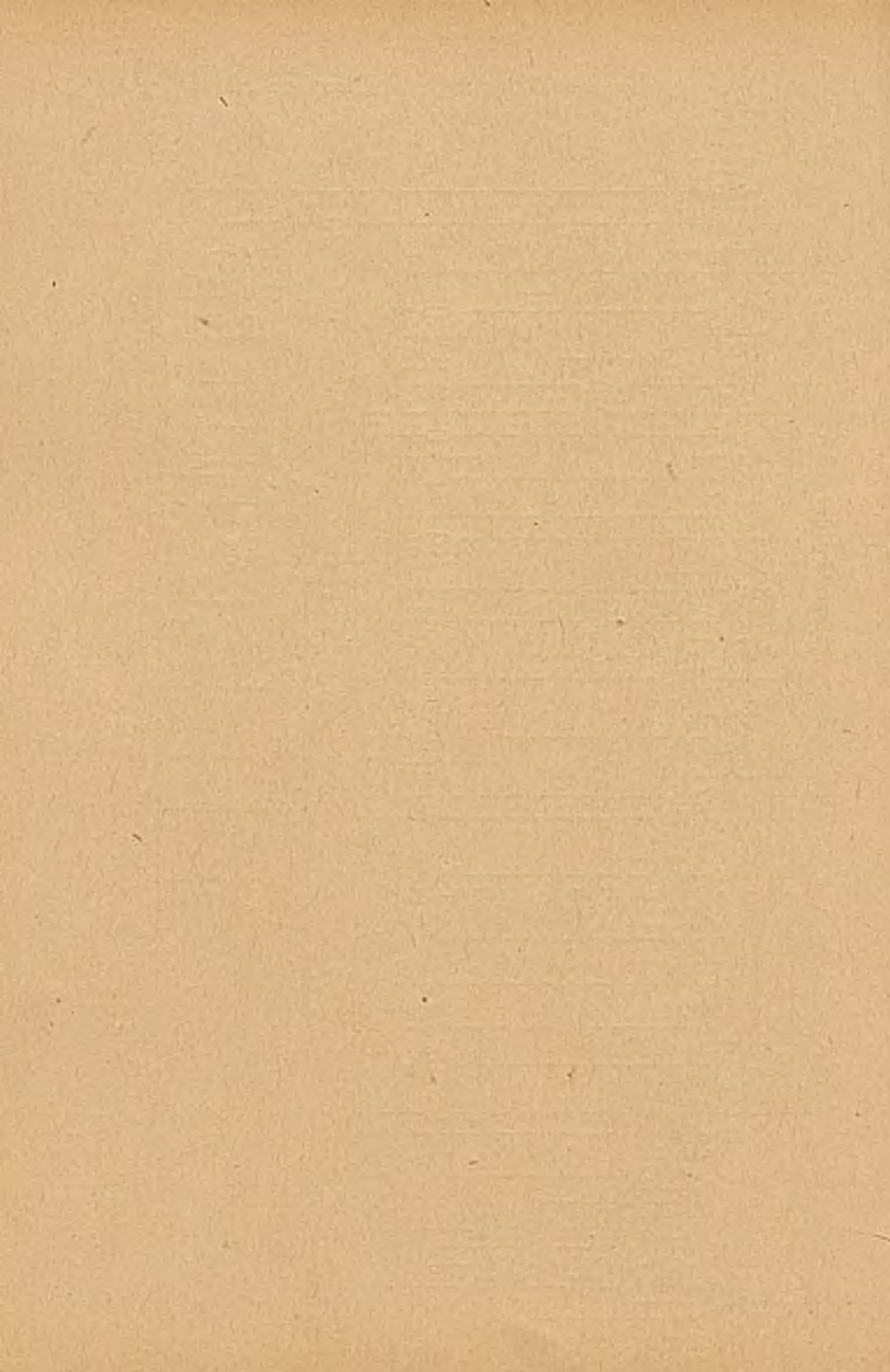

ELEKTRO-APPARATE-FABRIK
KÖPPELSDORF



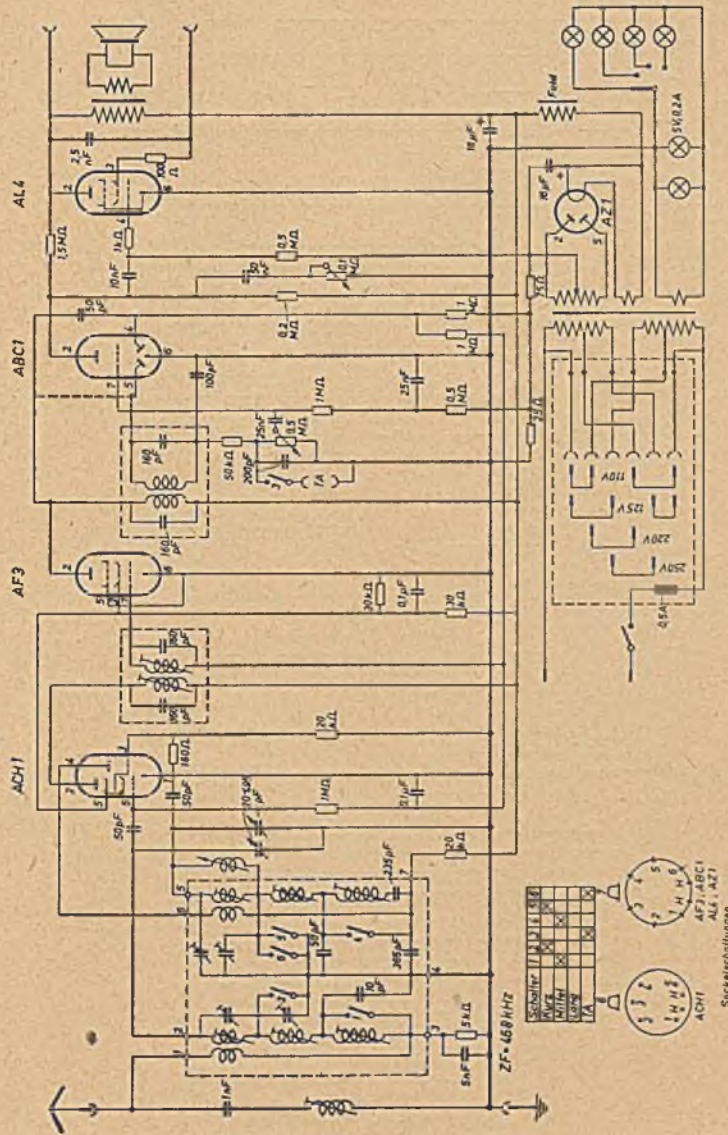

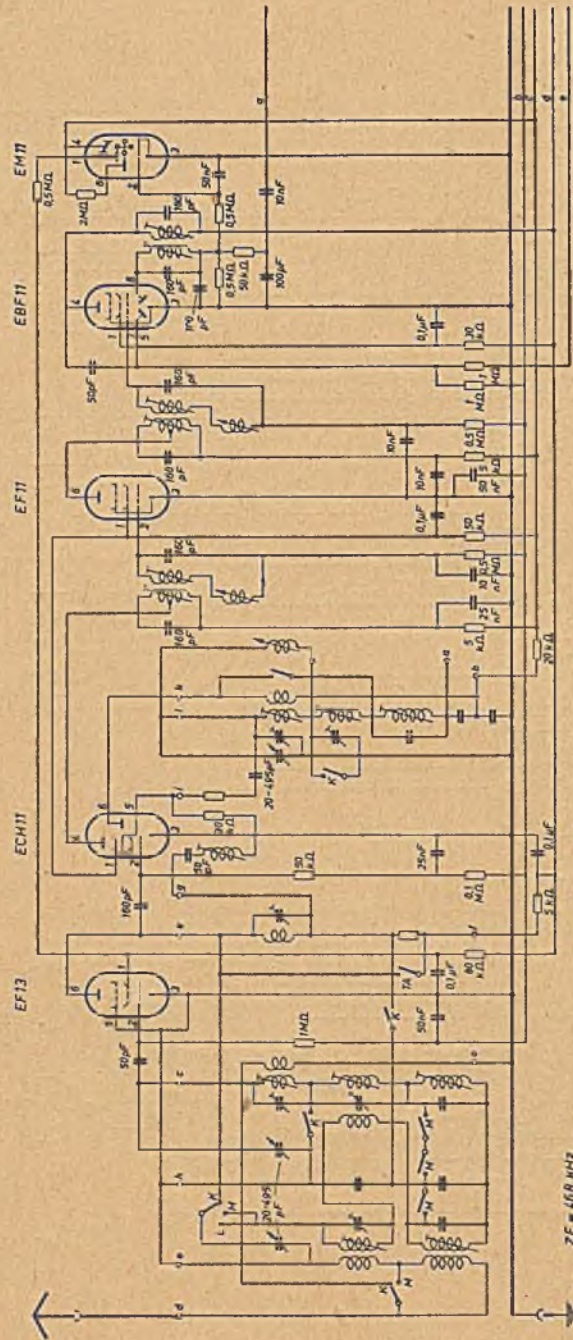

133
65 MHz
Sockelanschaltung

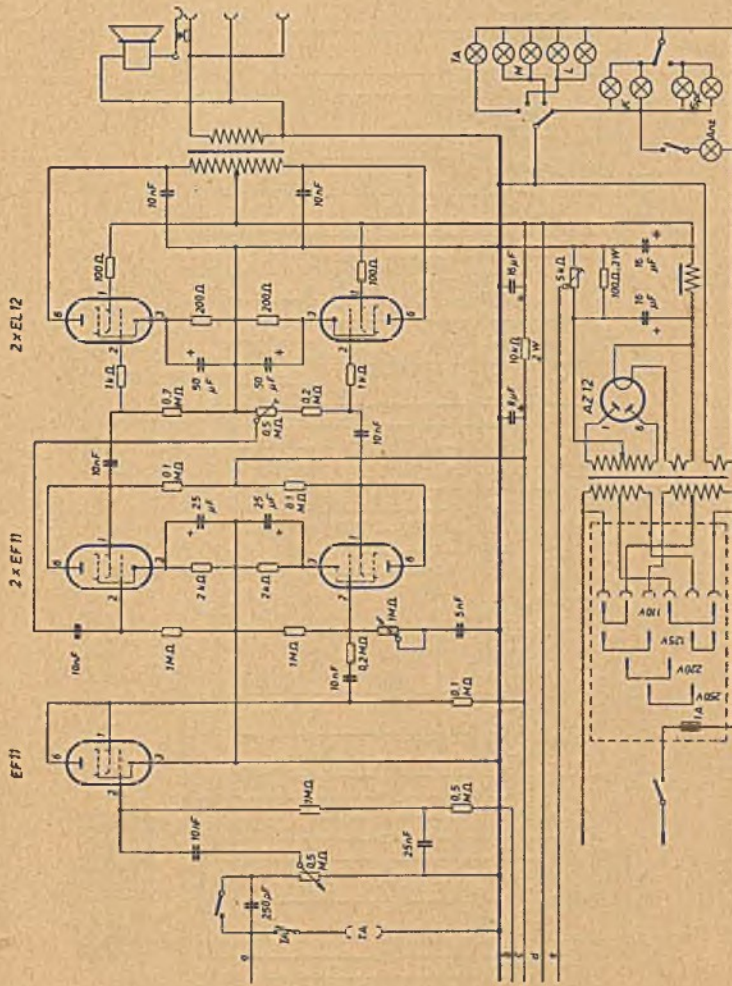

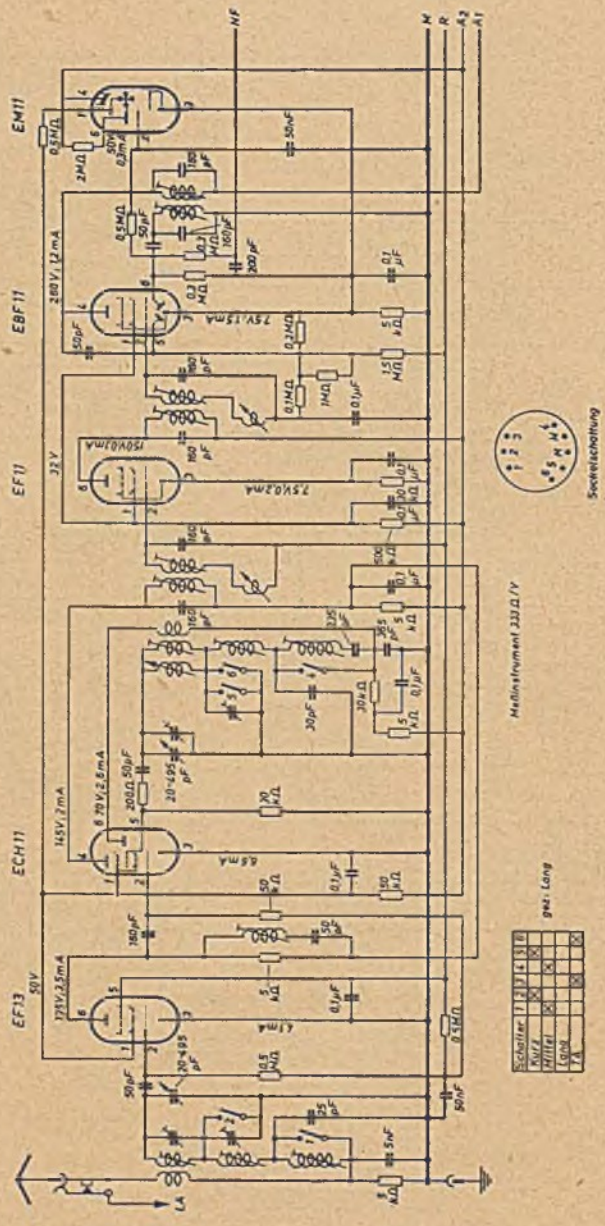

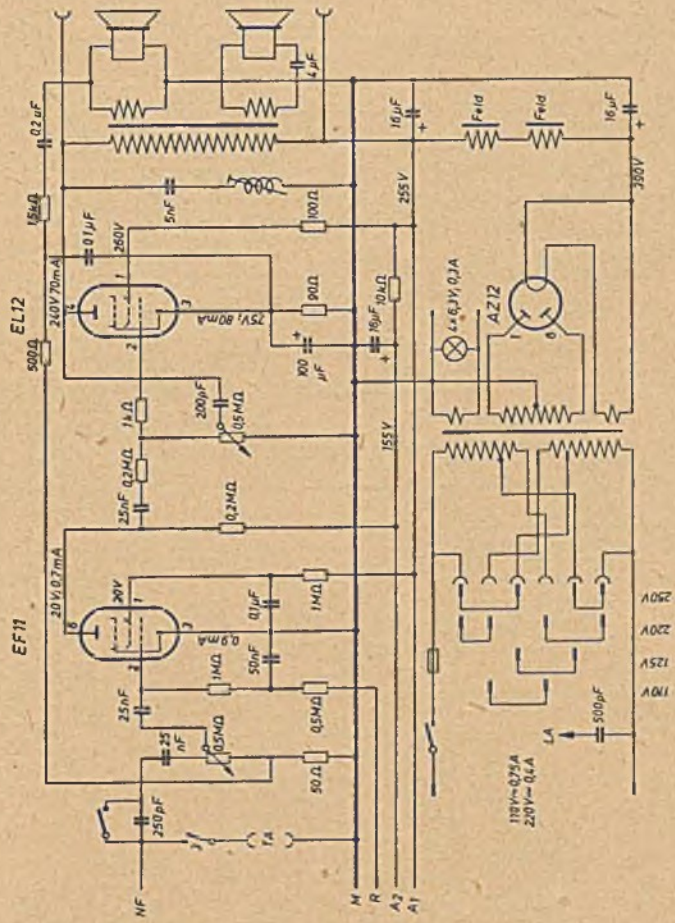

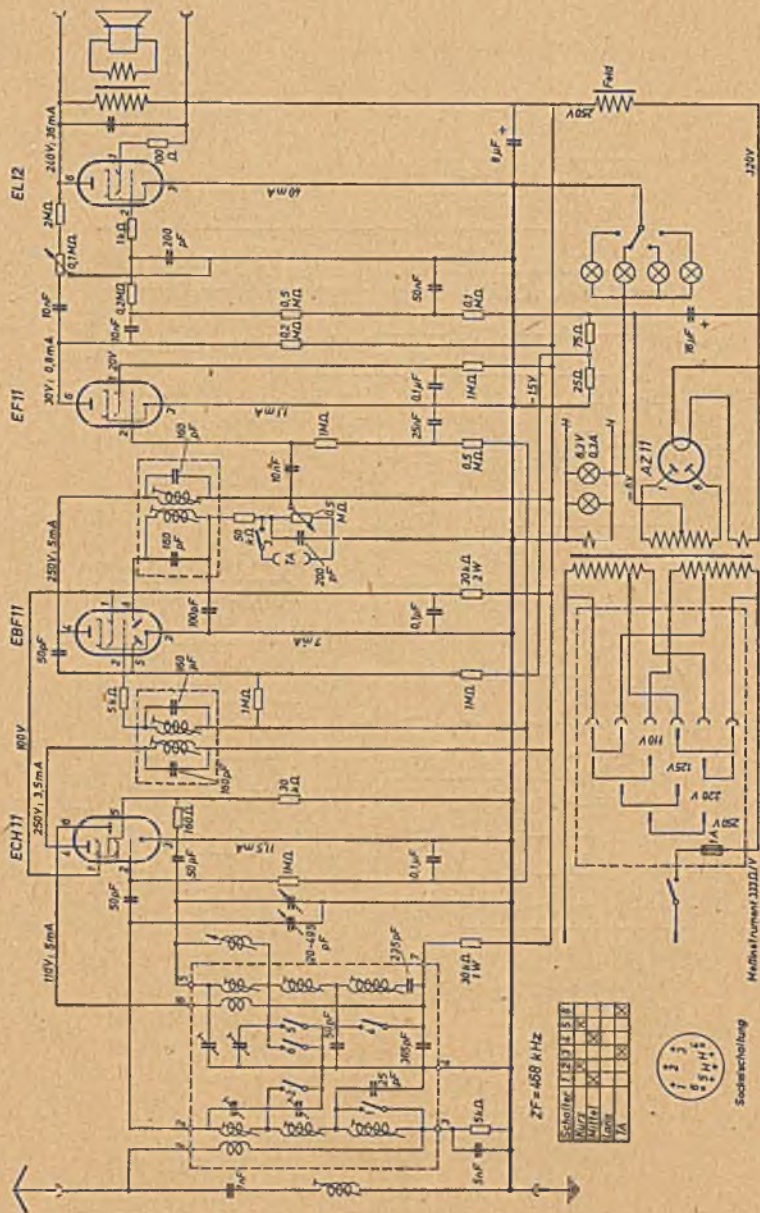

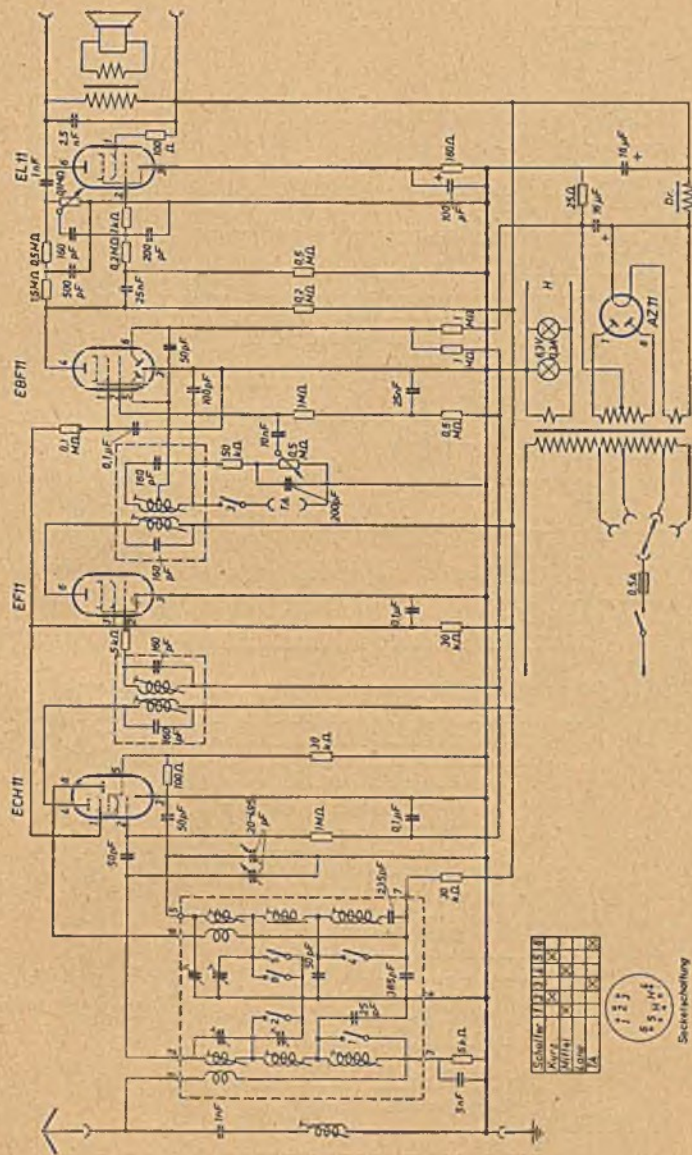

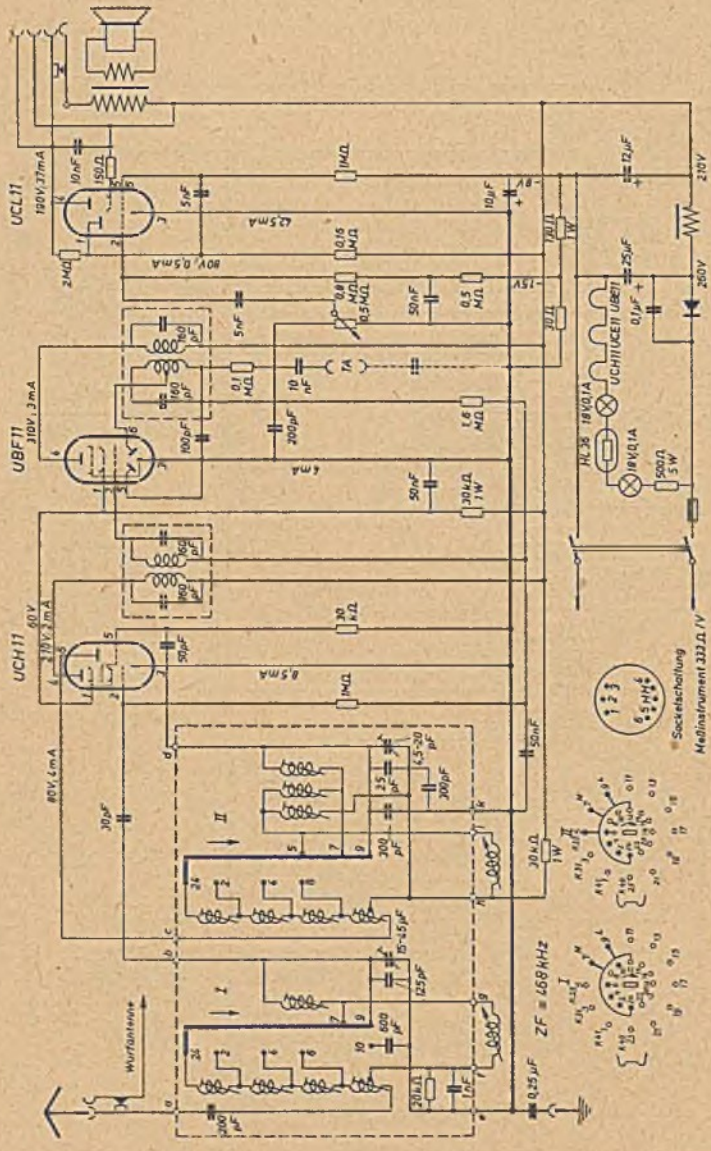

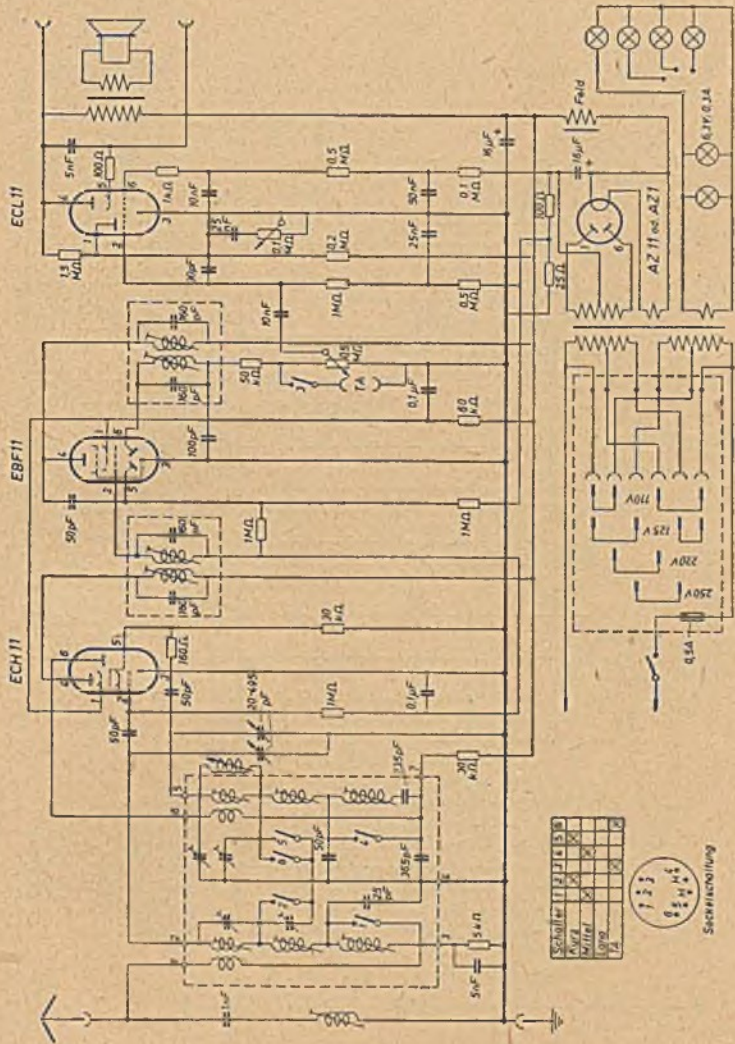

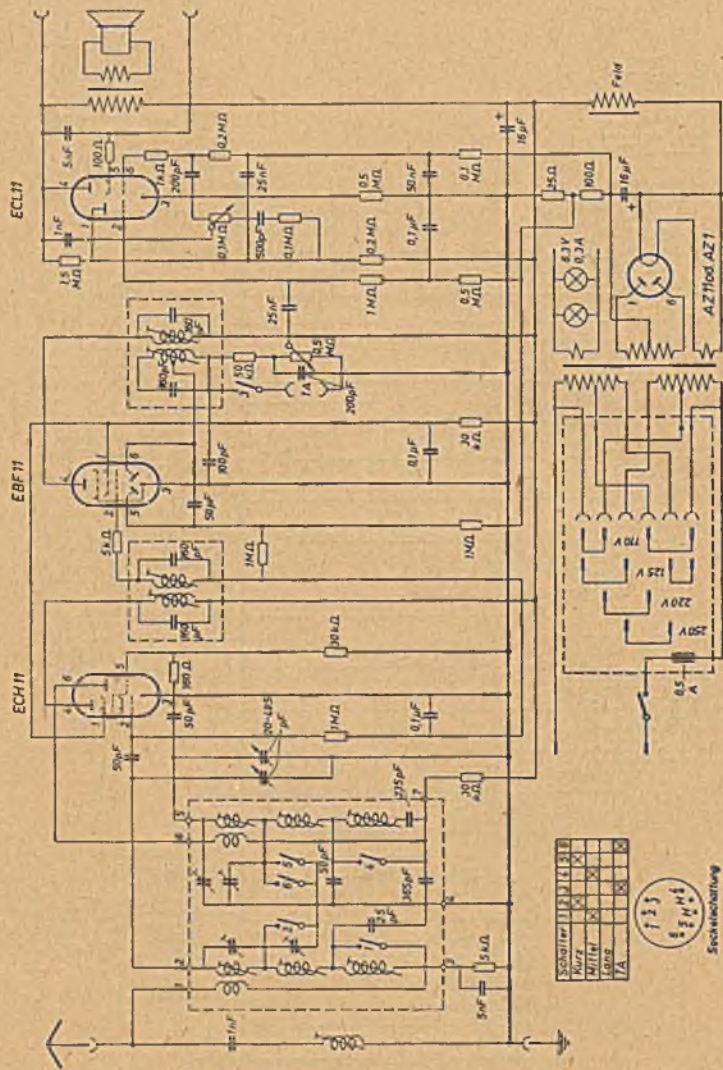

Schalter	1	2	3	4	5	6	7	8	9	10
Kurz										
Mittel										
Lang										
TA										



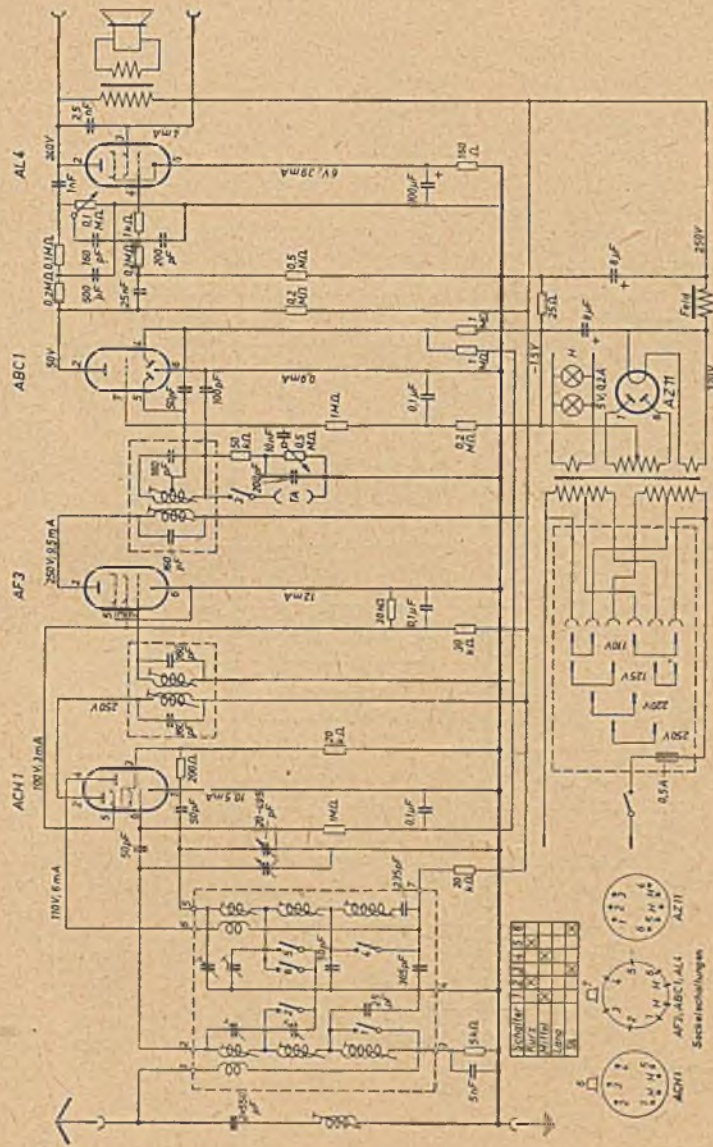

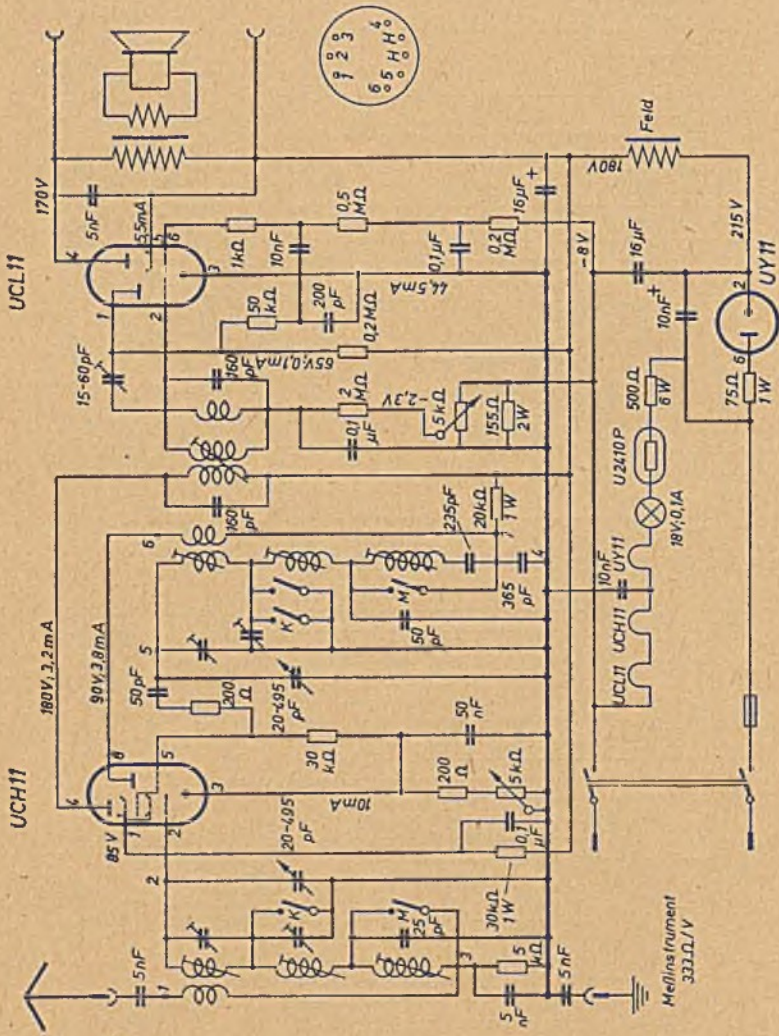

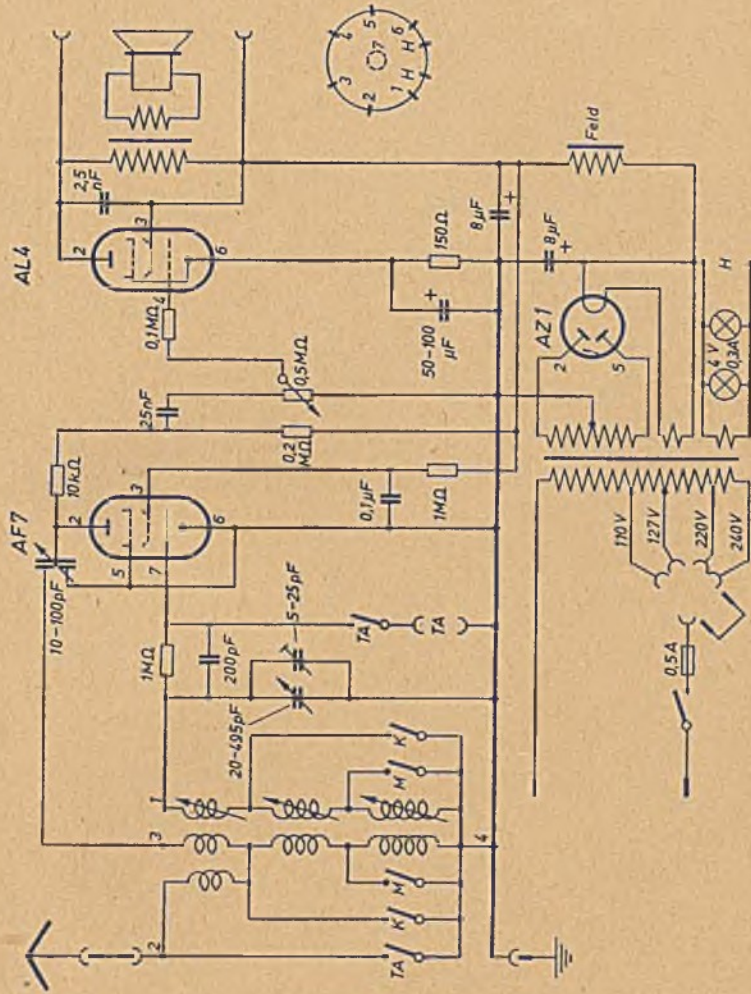



ELEKTRO-APPARATE-WERKE TREPTOW



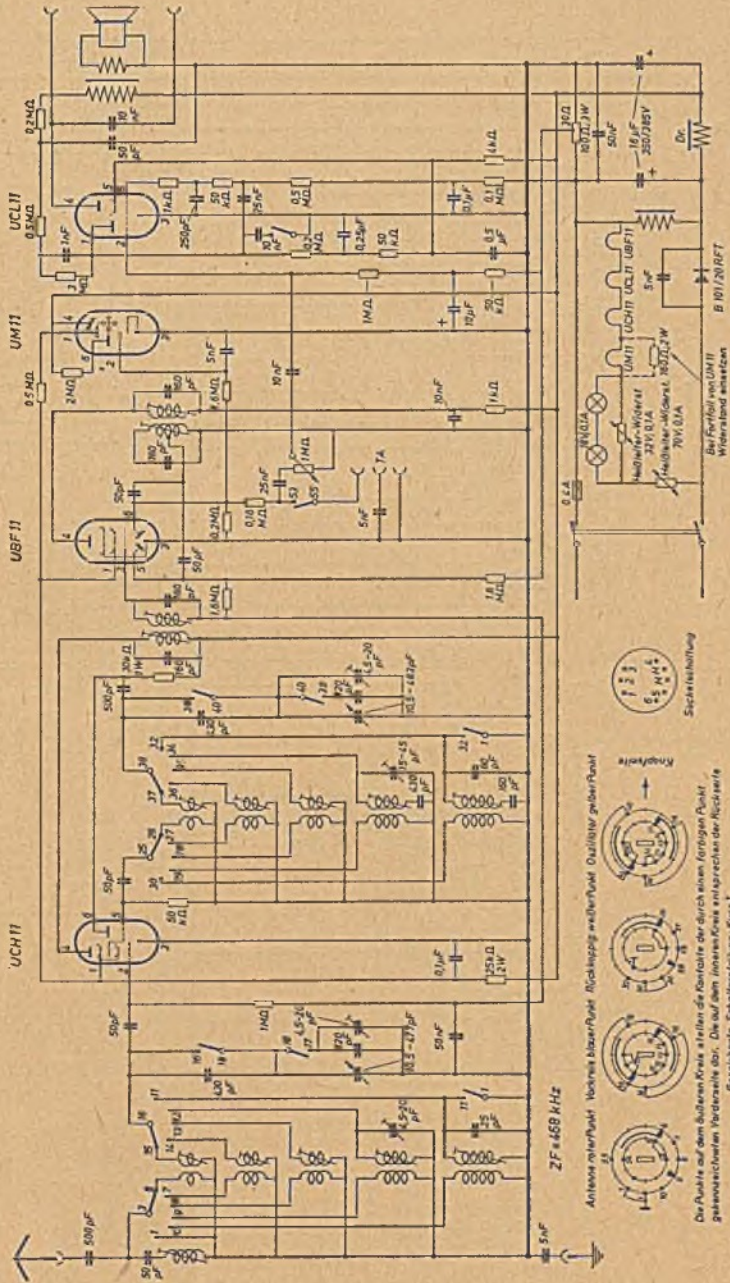

Die Punkte auf dem äußeren Kreis stellen die Kontakte dar durch einen farbigen Punkt genaueren Verbindungs- und auf dem inneren Kreis entsprechen die Anschlüsse der Anschlüsse. Gezeichnete Schalterstellung (dunkel)

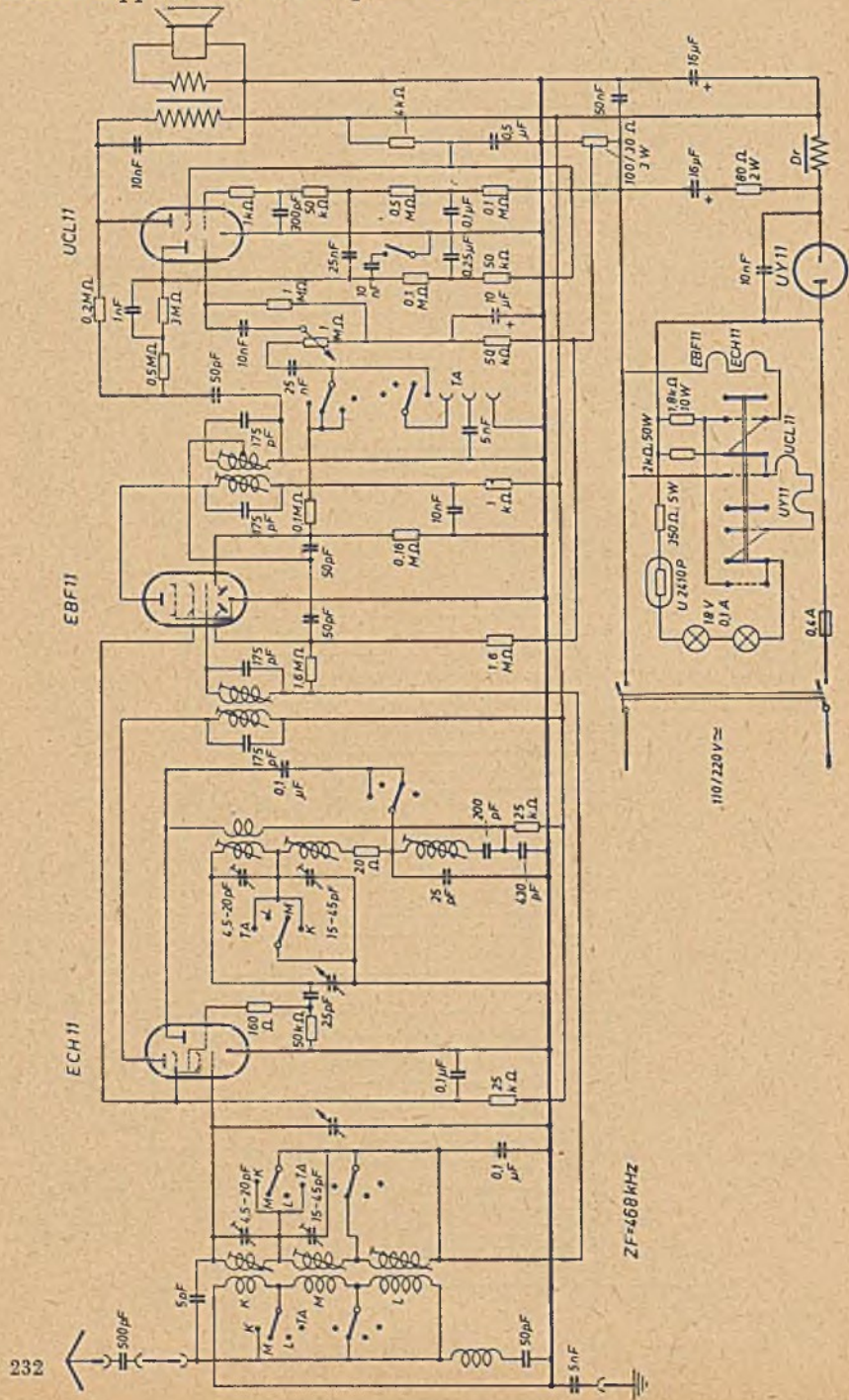

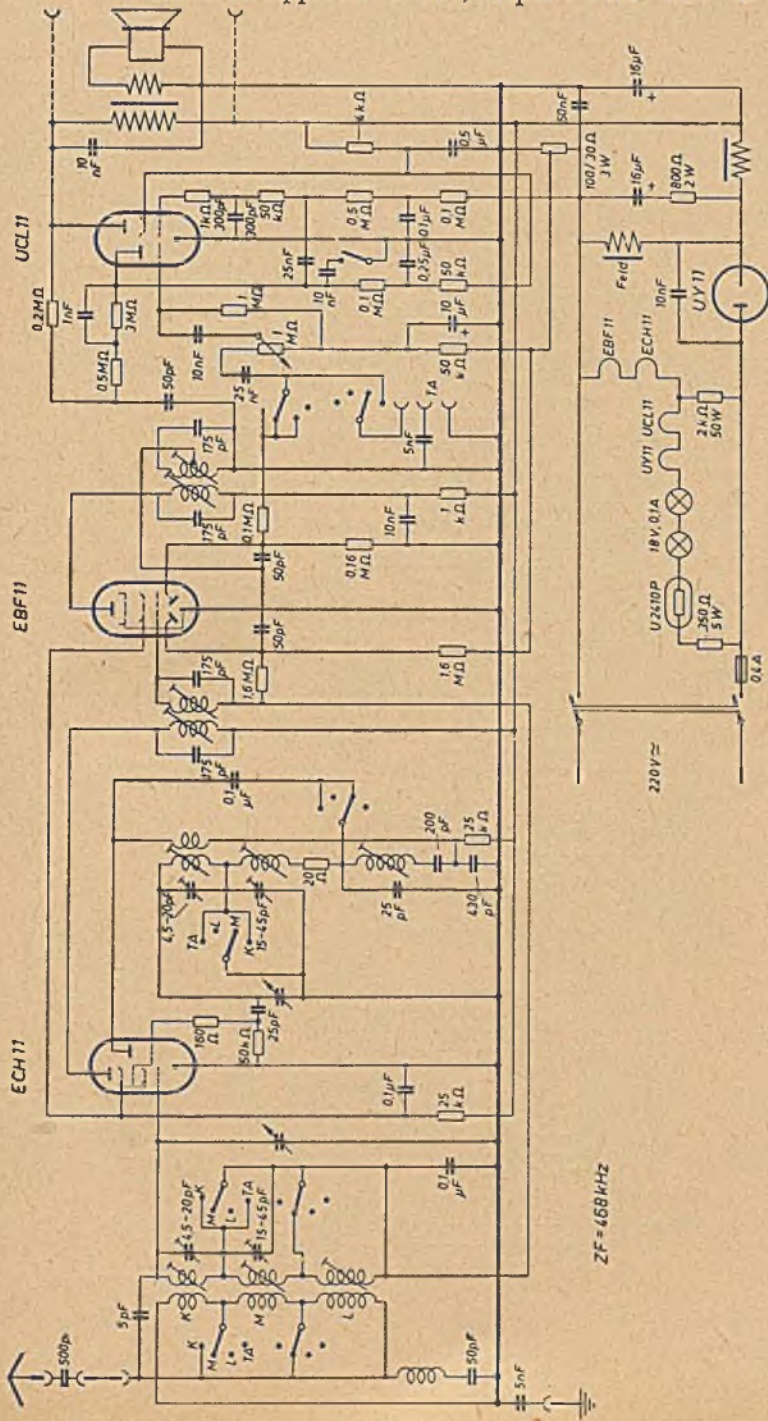

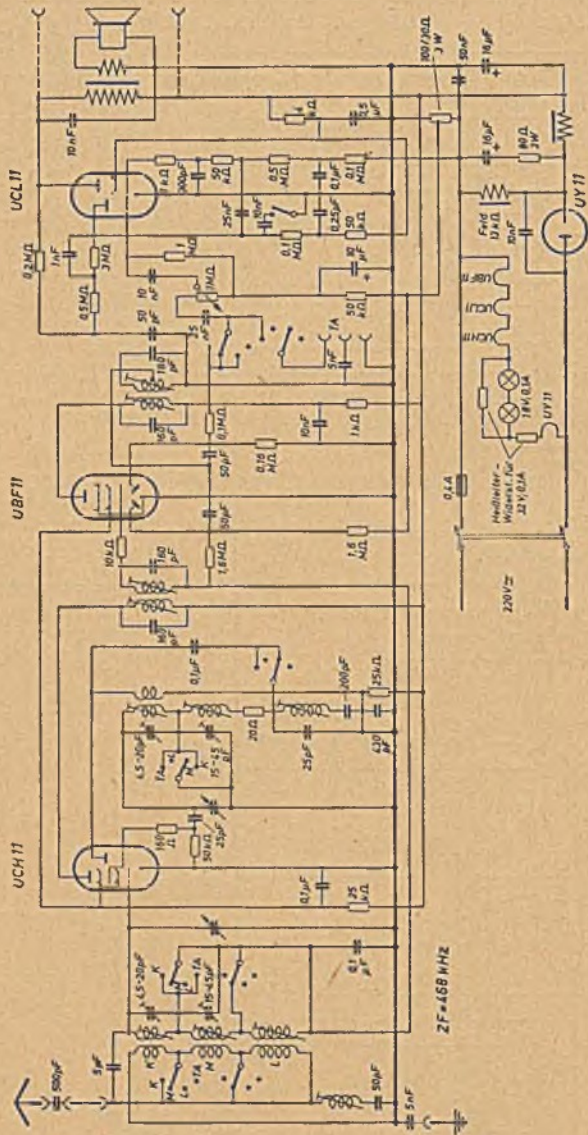

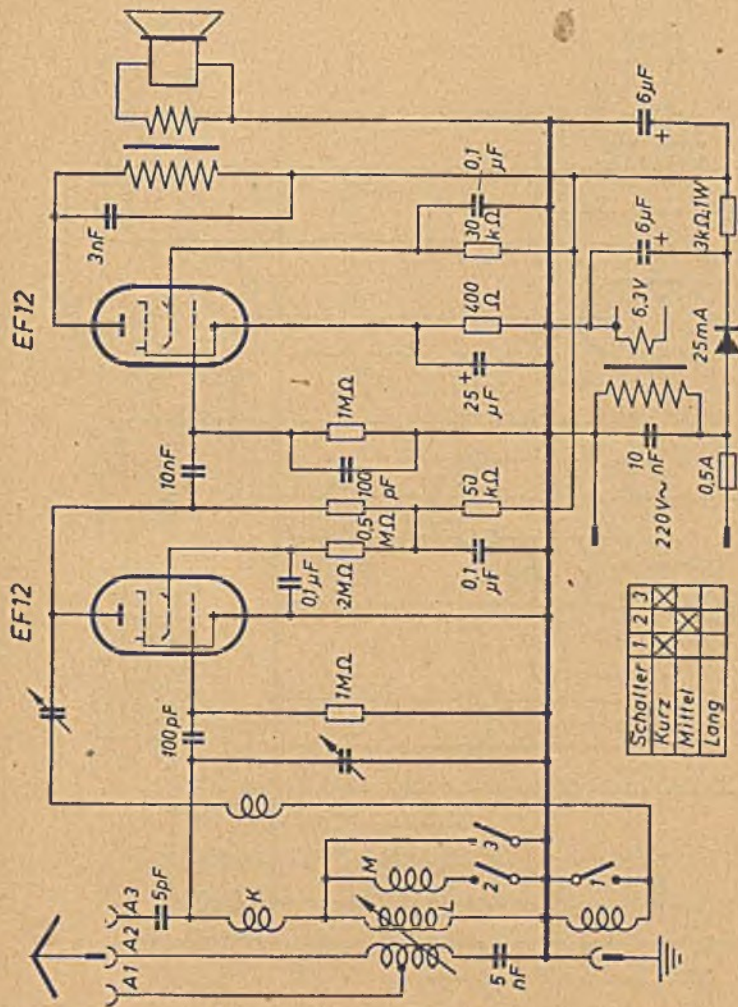

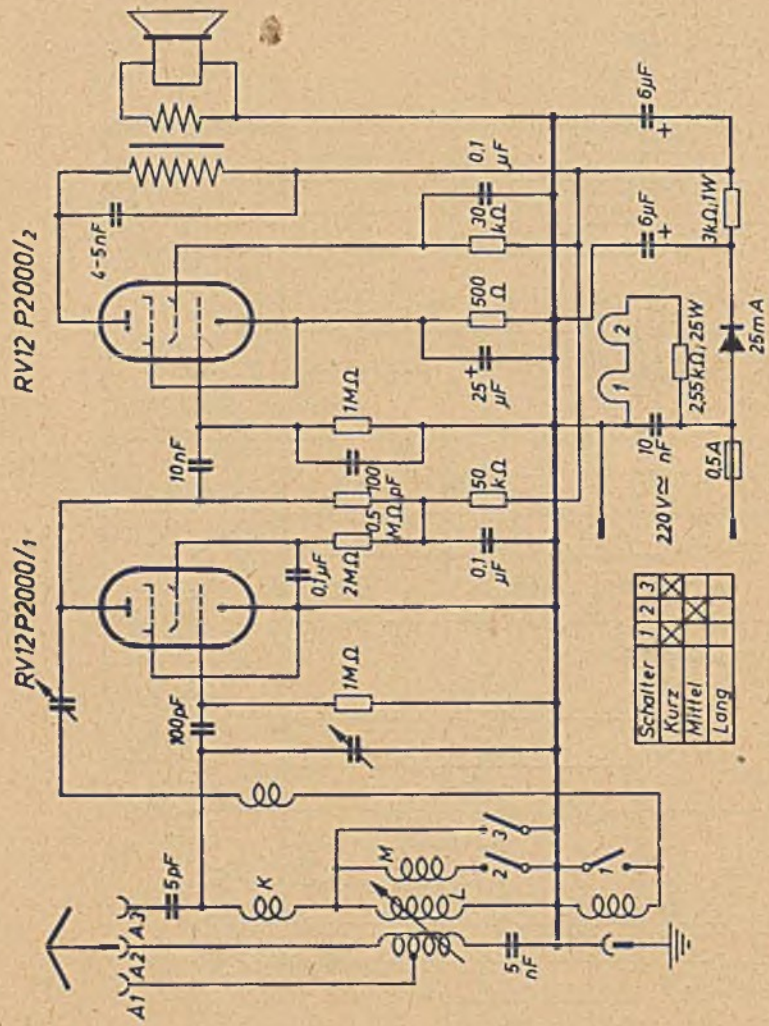

ELMUG



POLITECHNIKA ŚLĄSKA
Katedra Elektroniki Przemysłowej

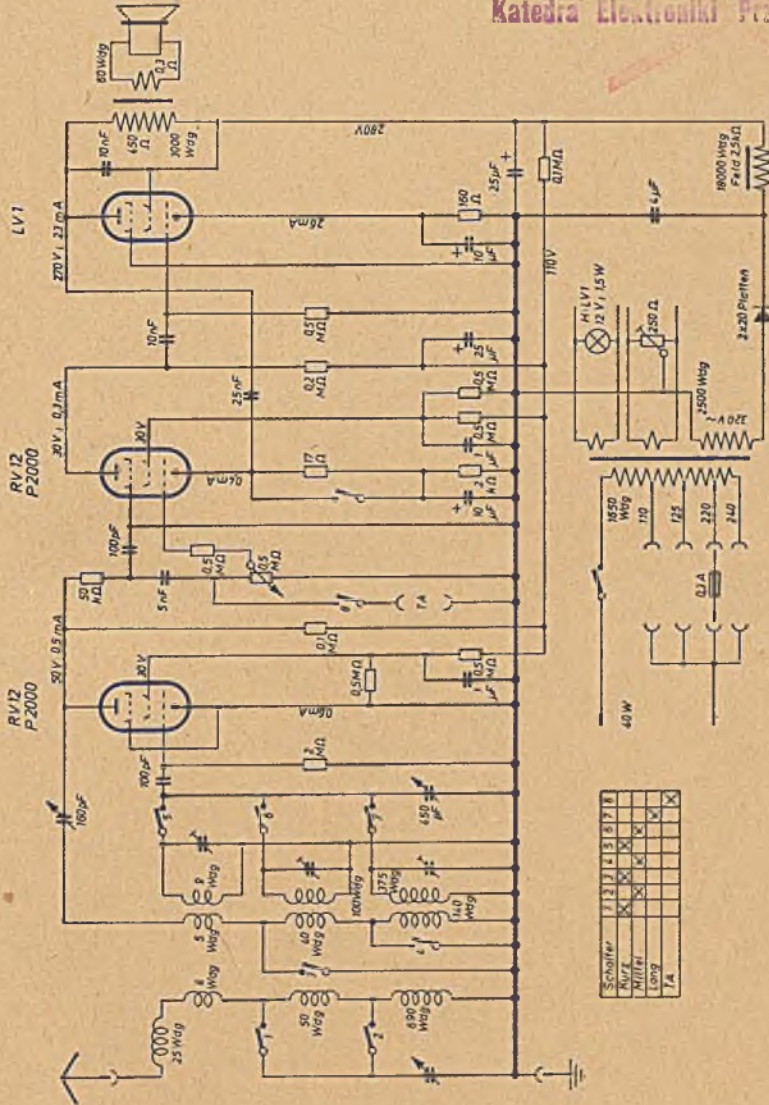

Schalter	1	2	3	4	5	6	7	8	9	10
RV12										
RV12										
RV12										
YA										

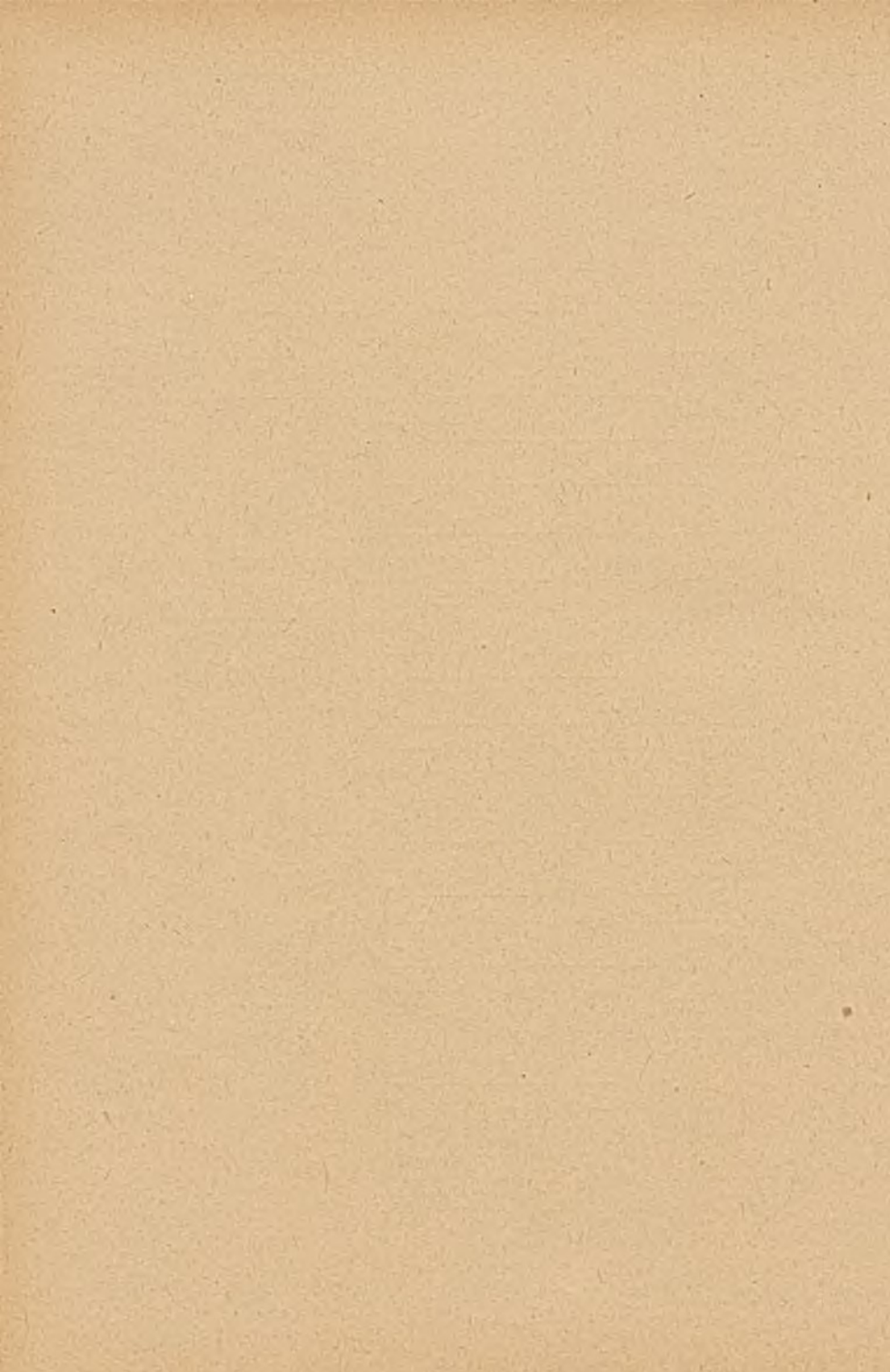

ELTRA

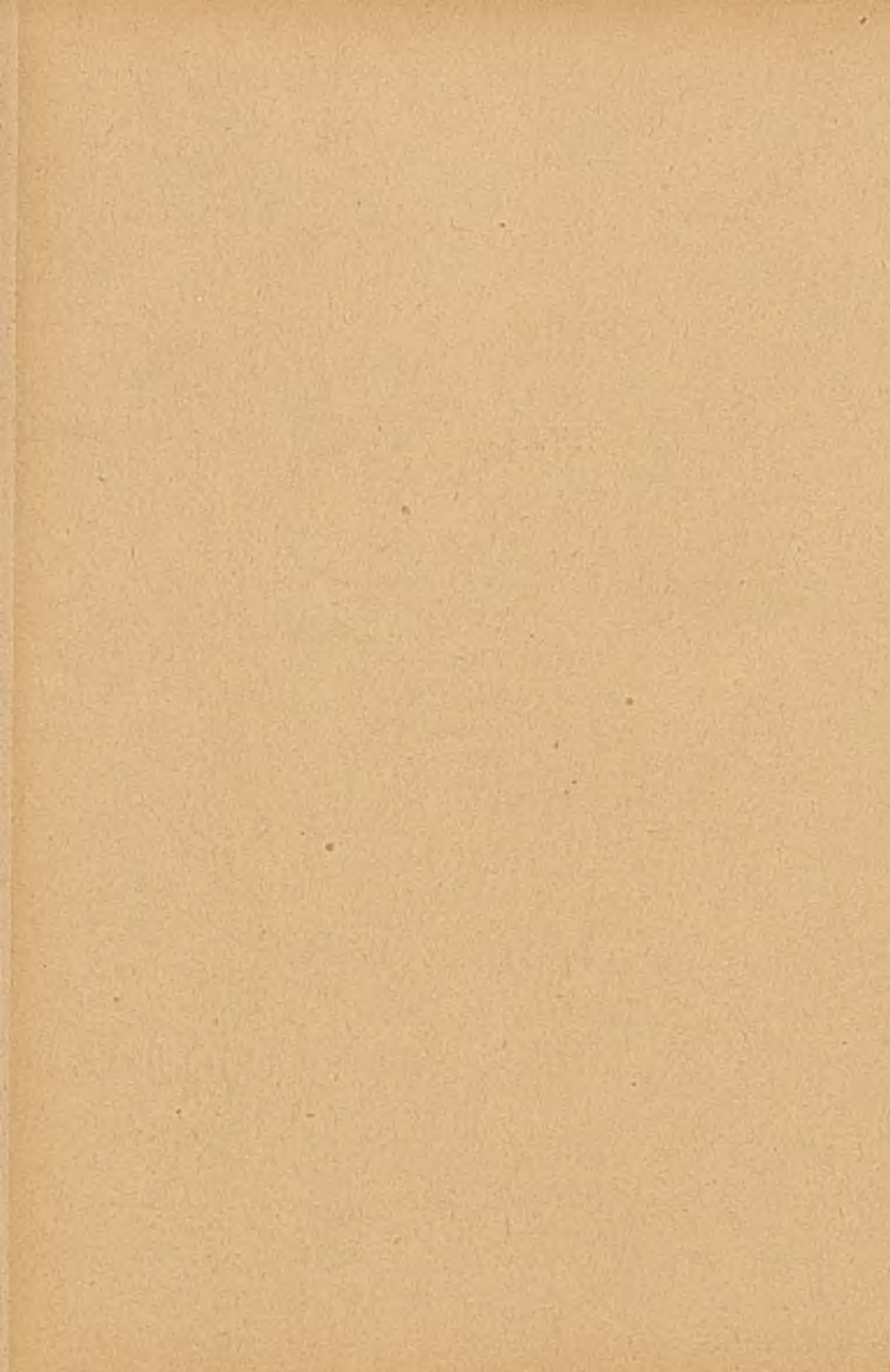

Eltra
249 GWK

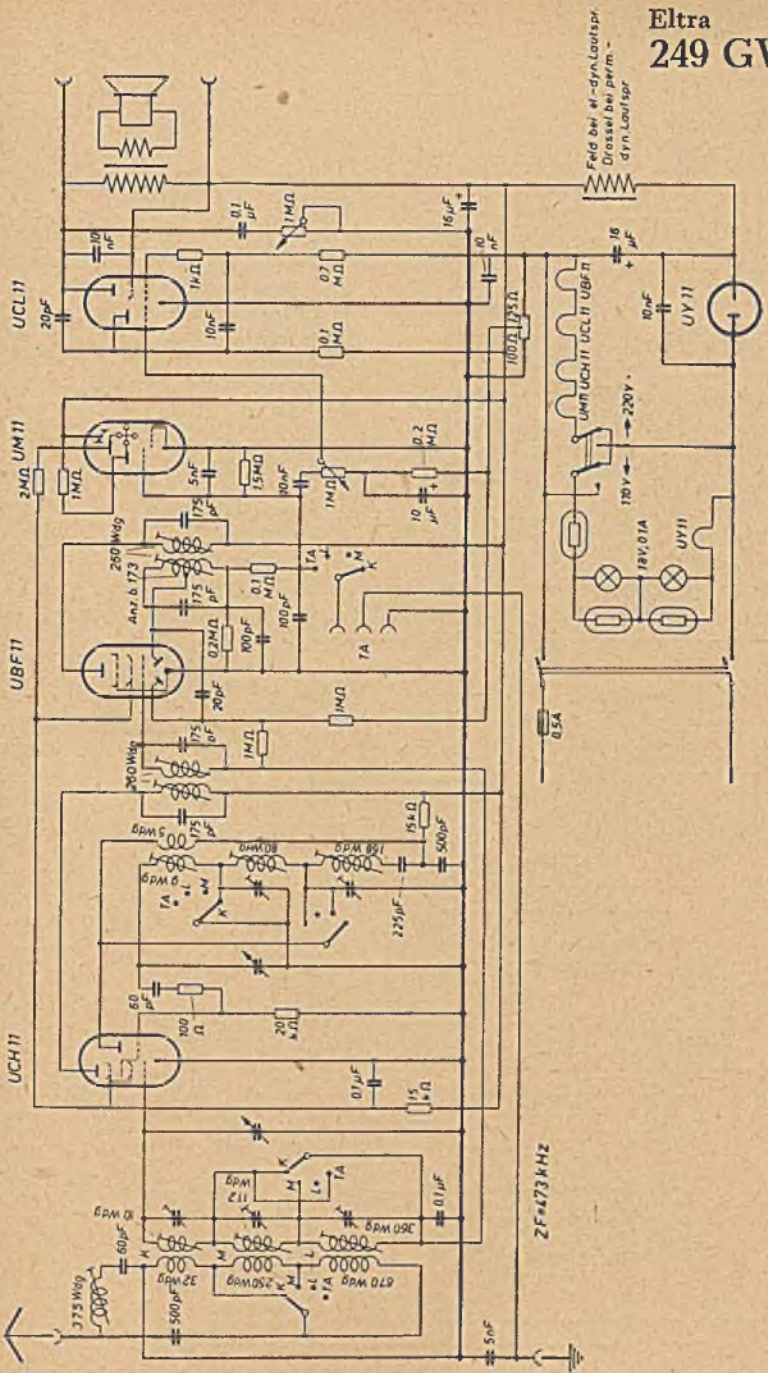

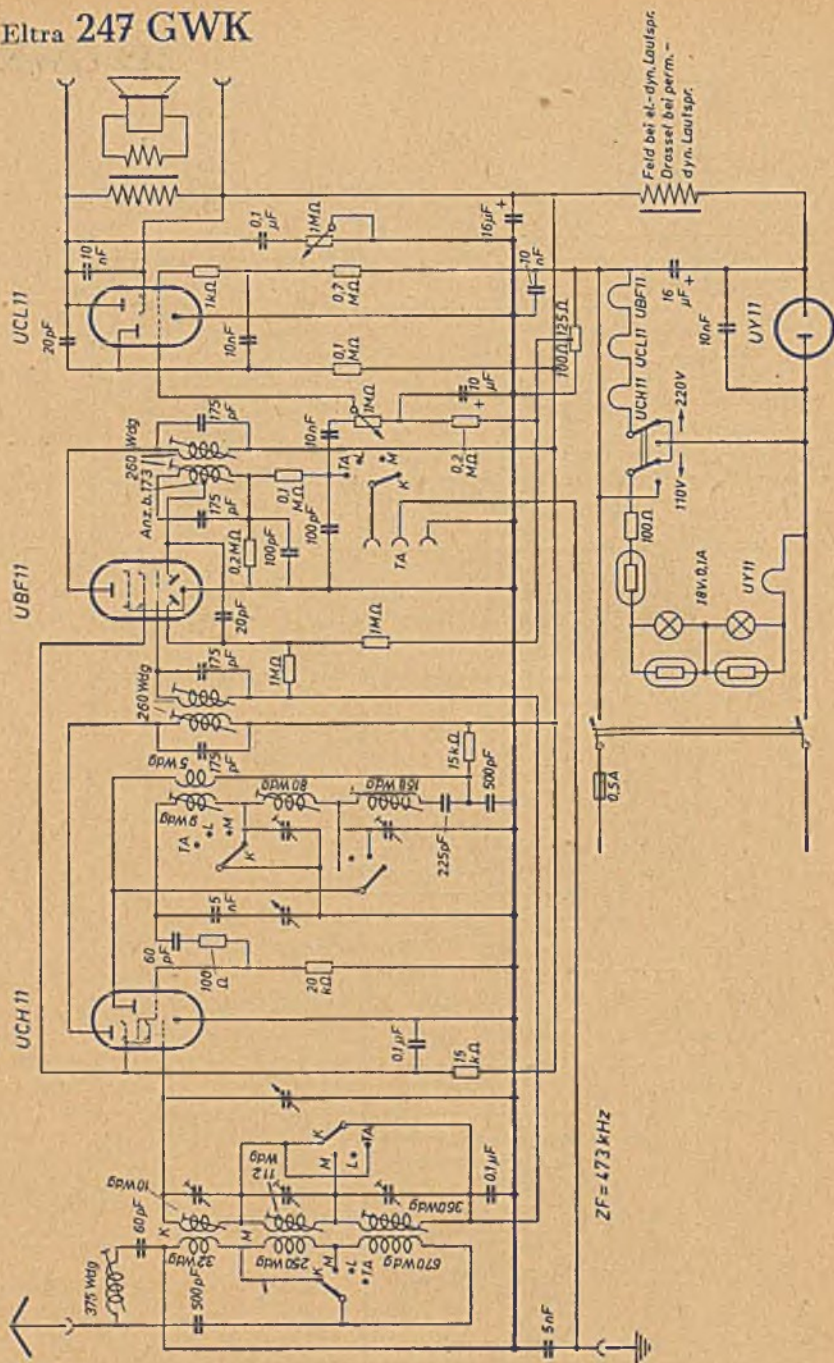

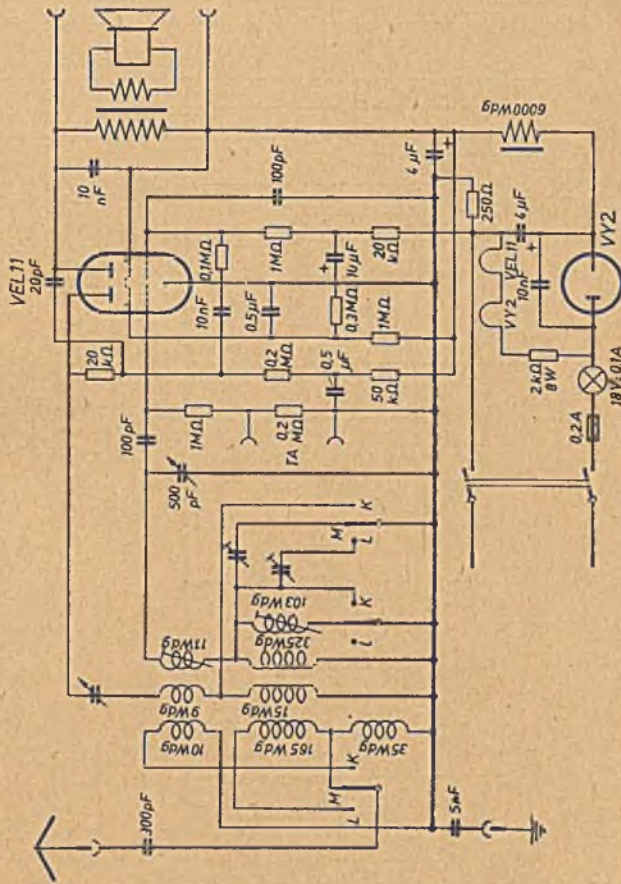

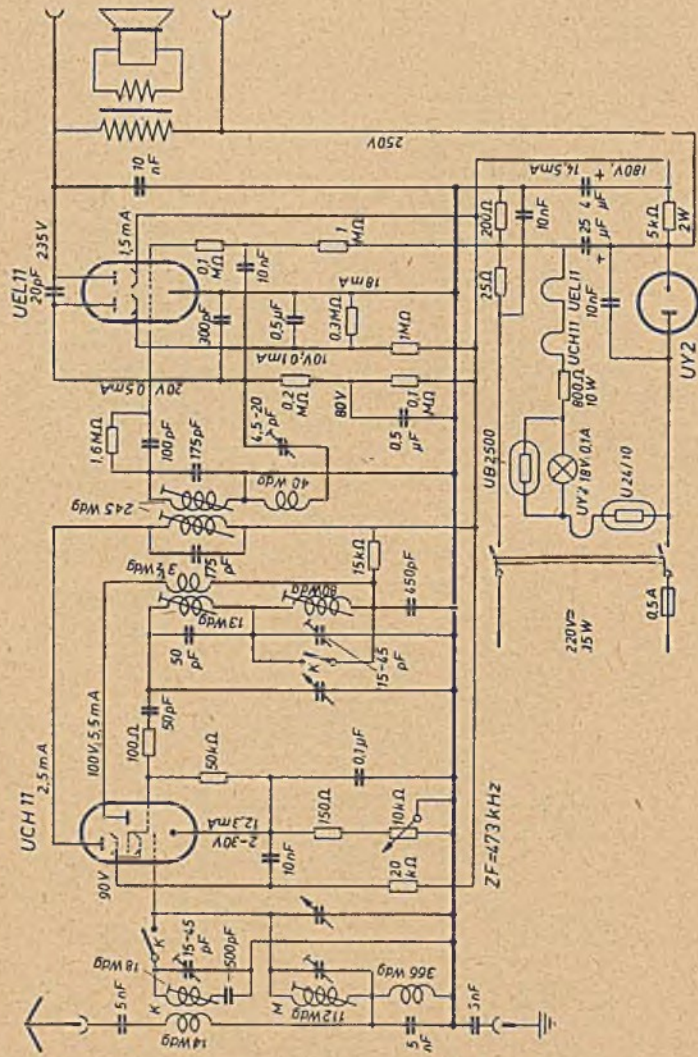

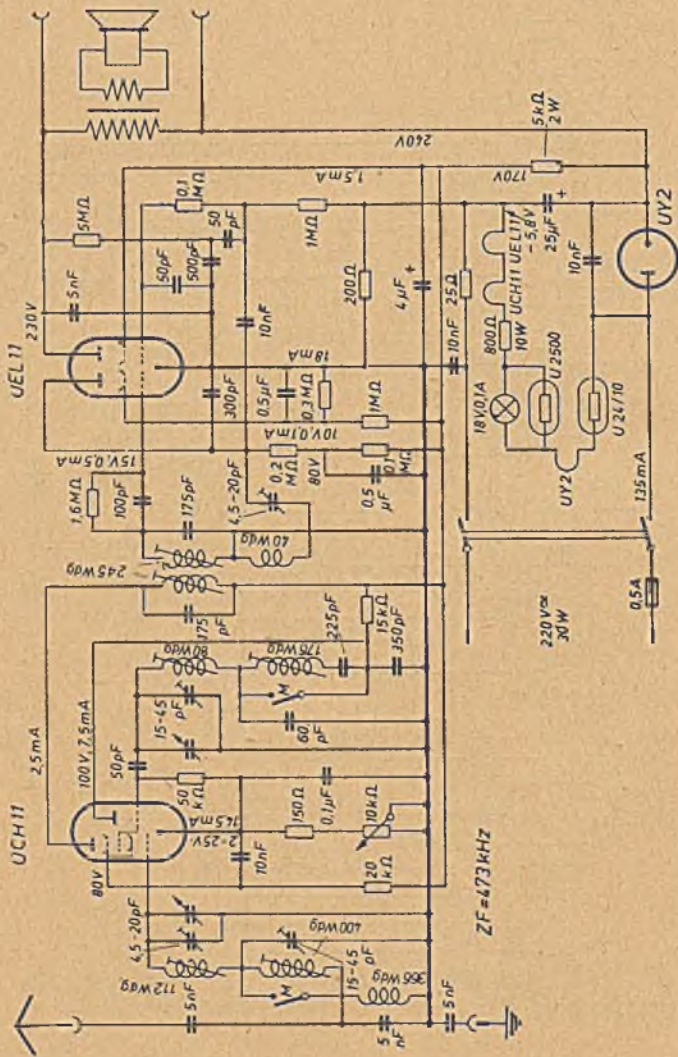

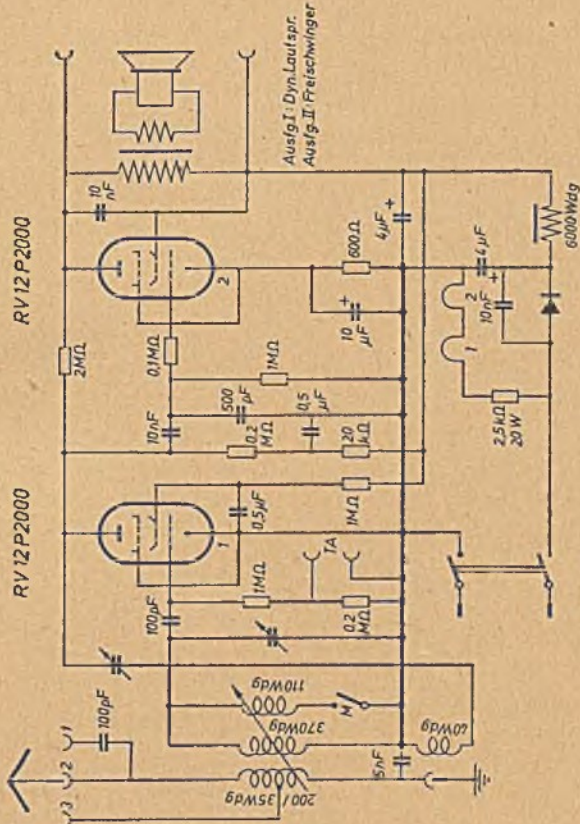



EMUD
(Produktion nach 1945)



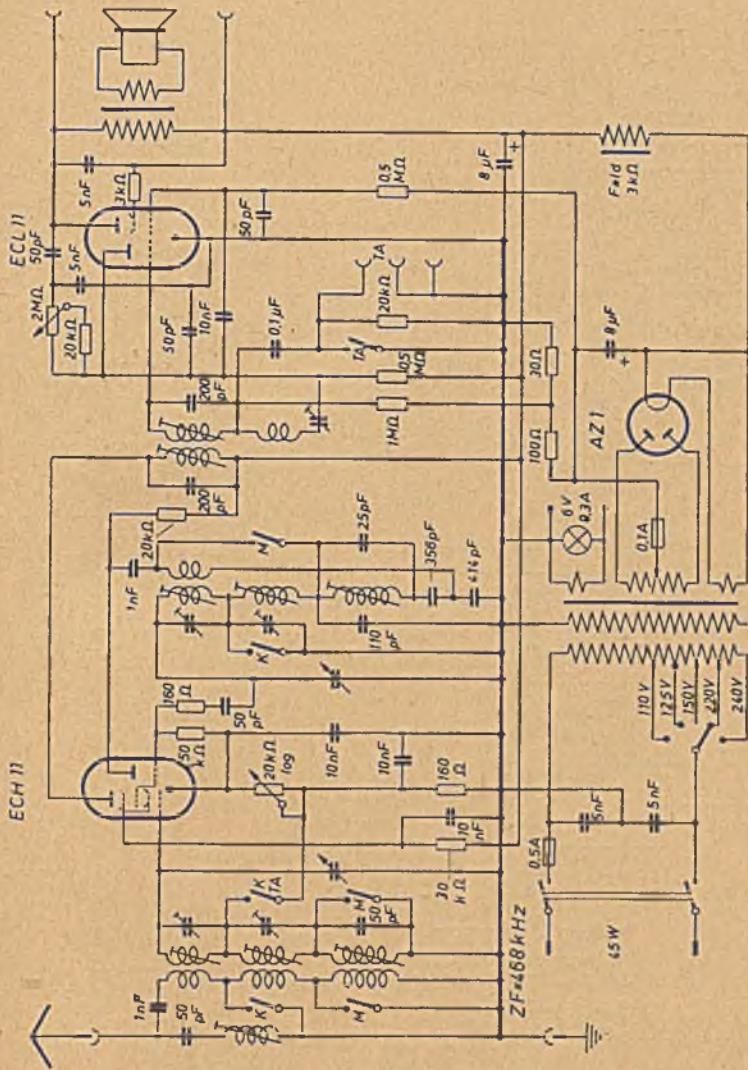

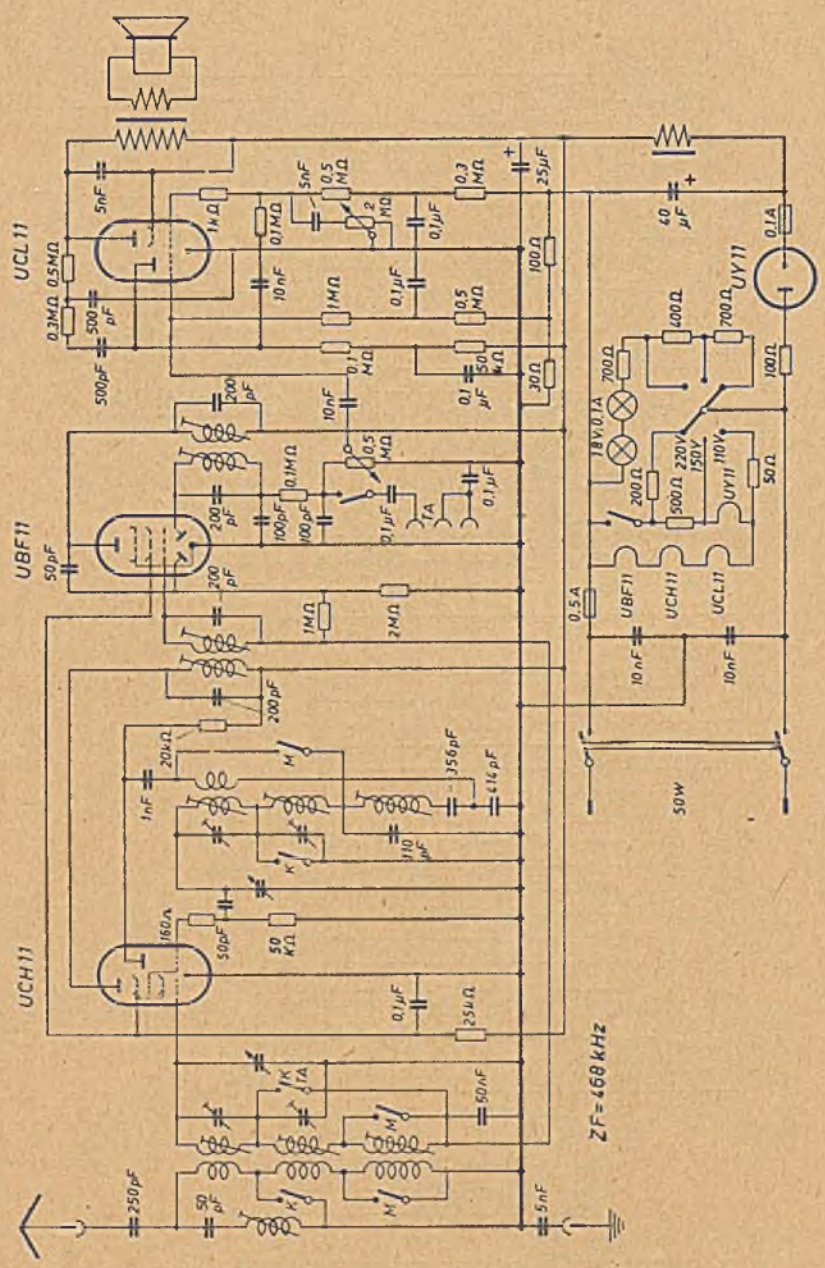

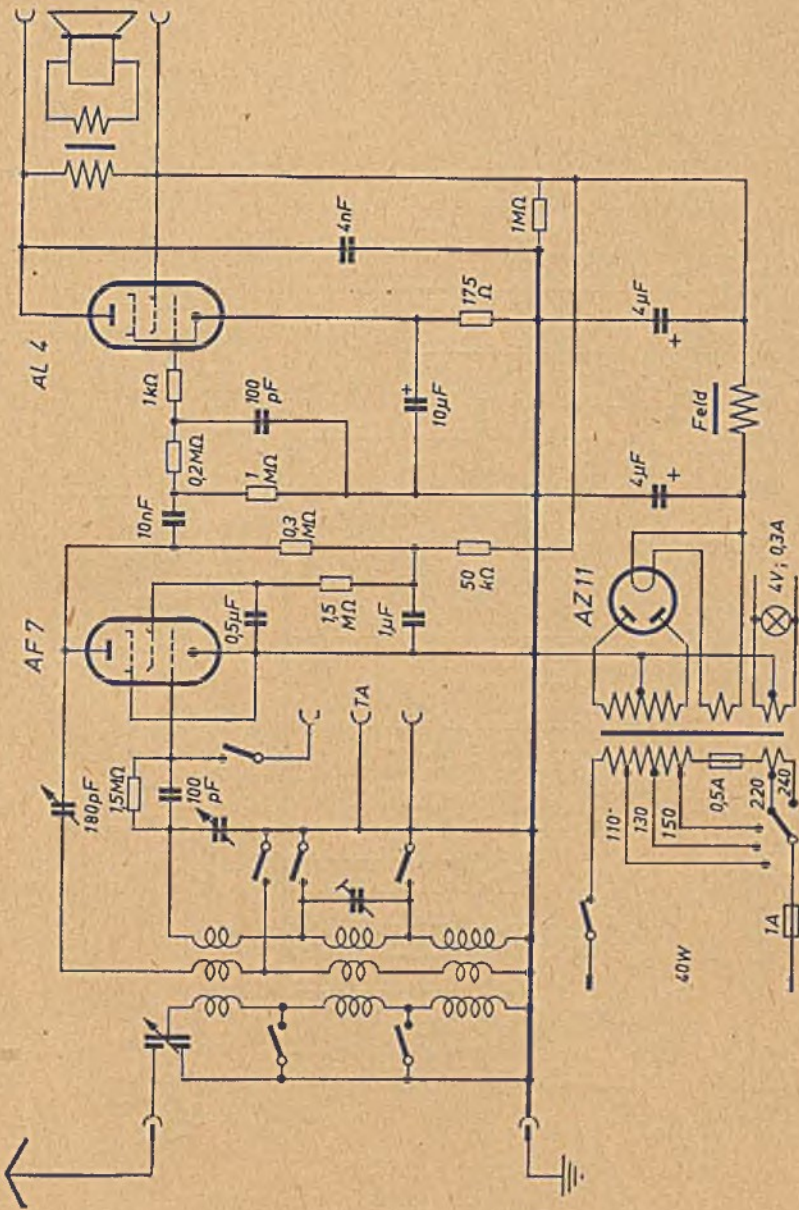

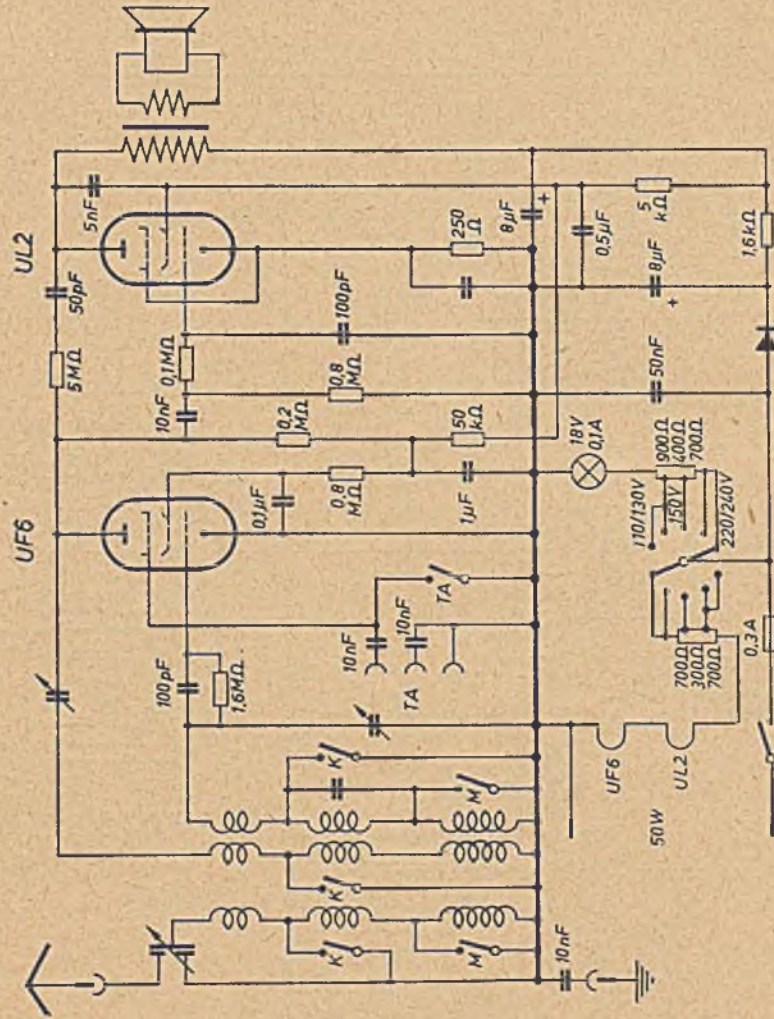

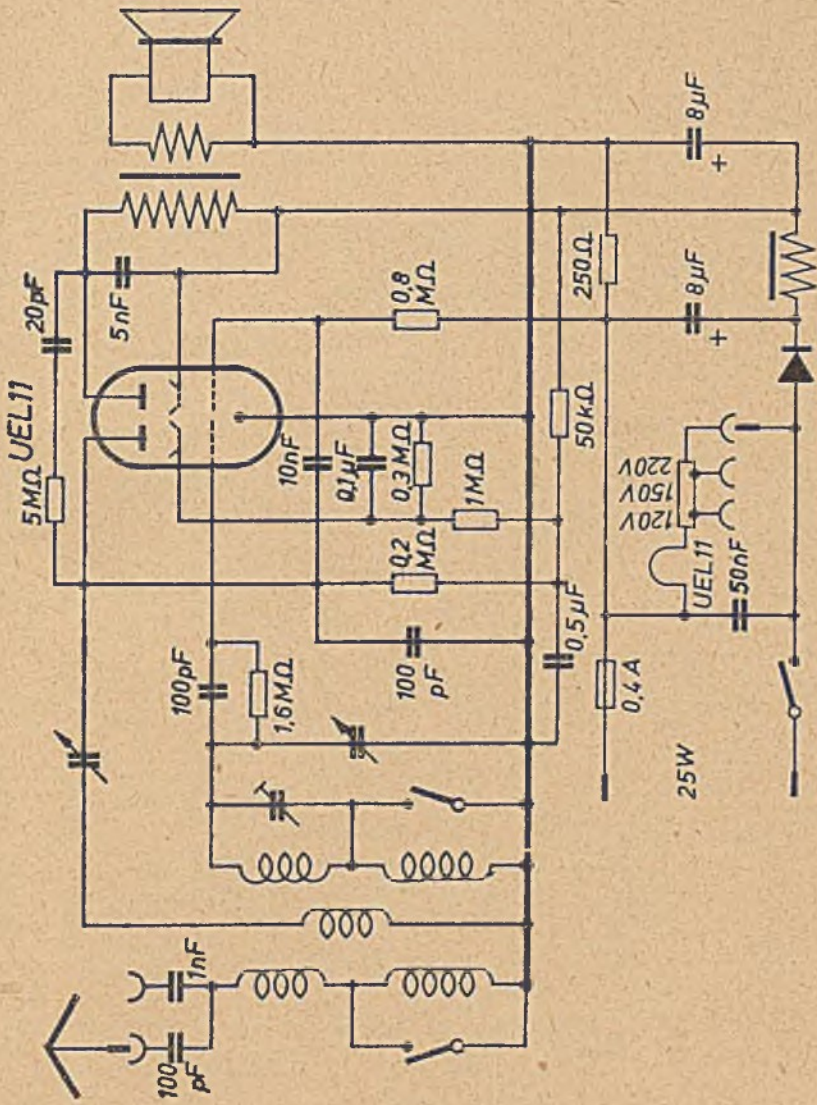



EMUD

(Produktion vor 1945)



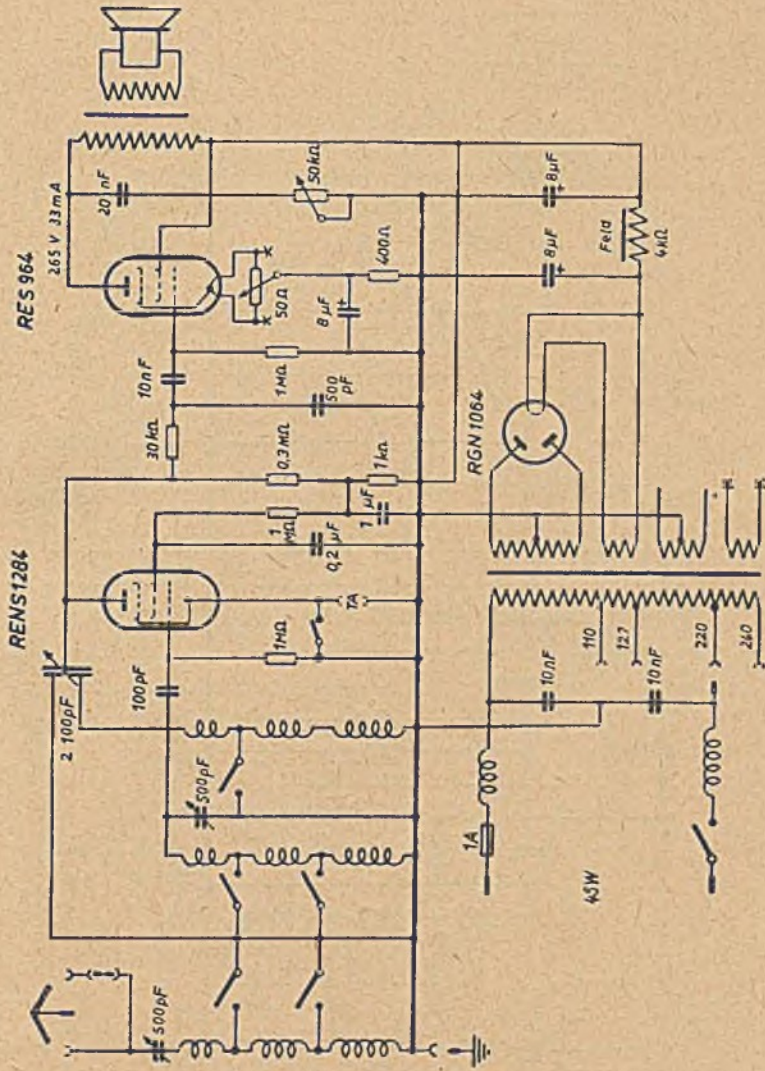

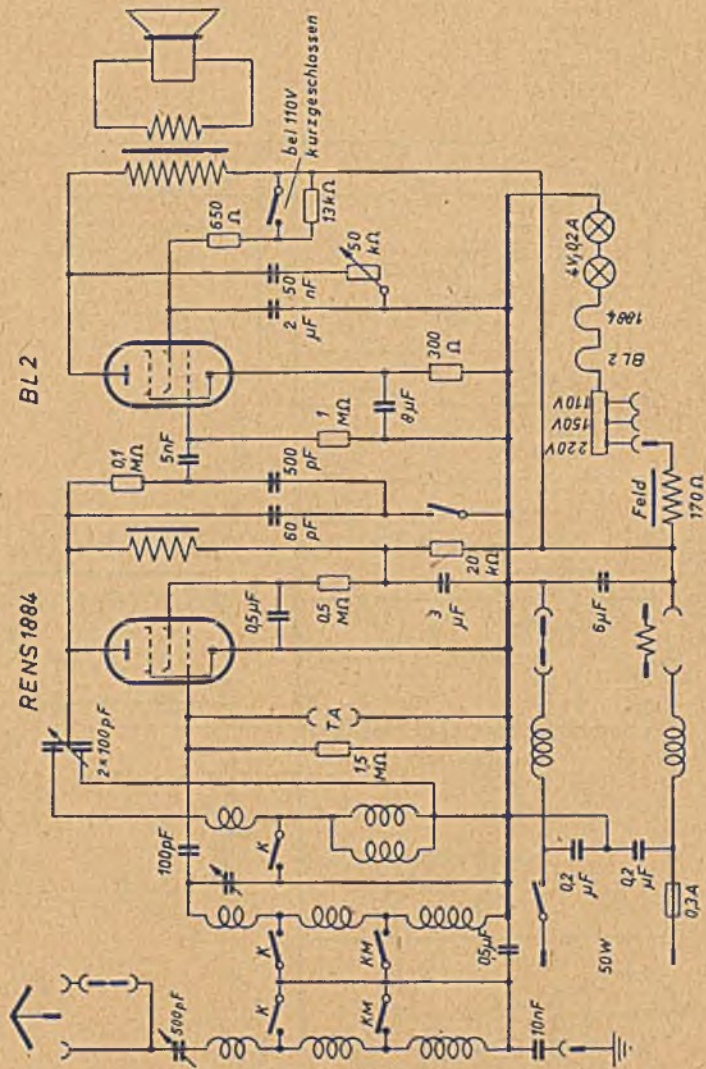

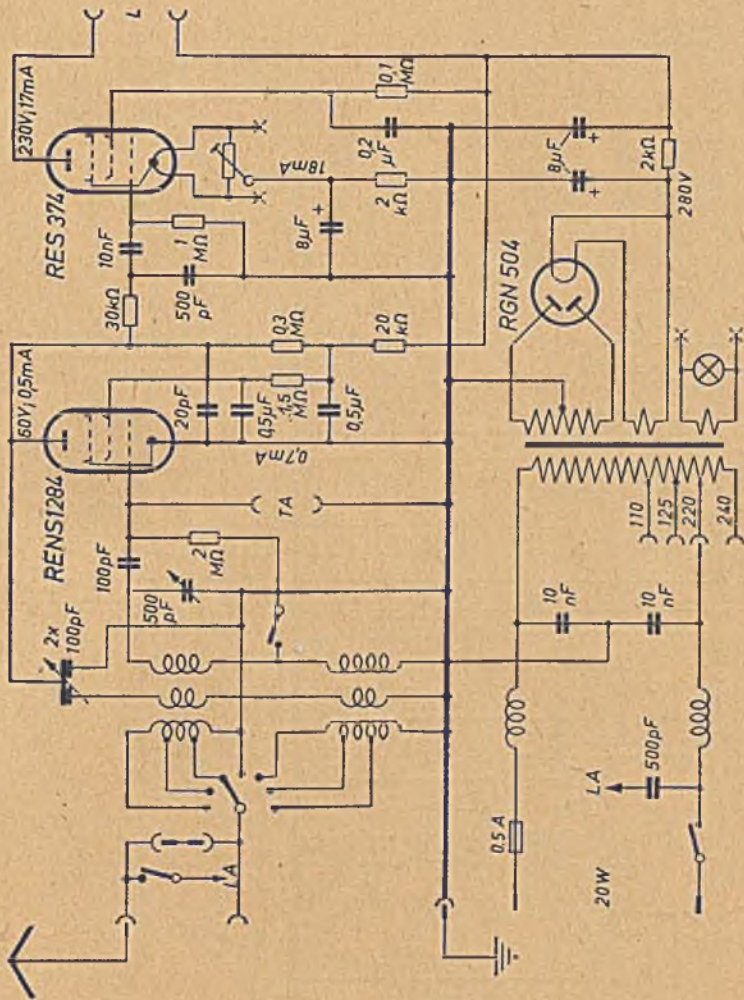

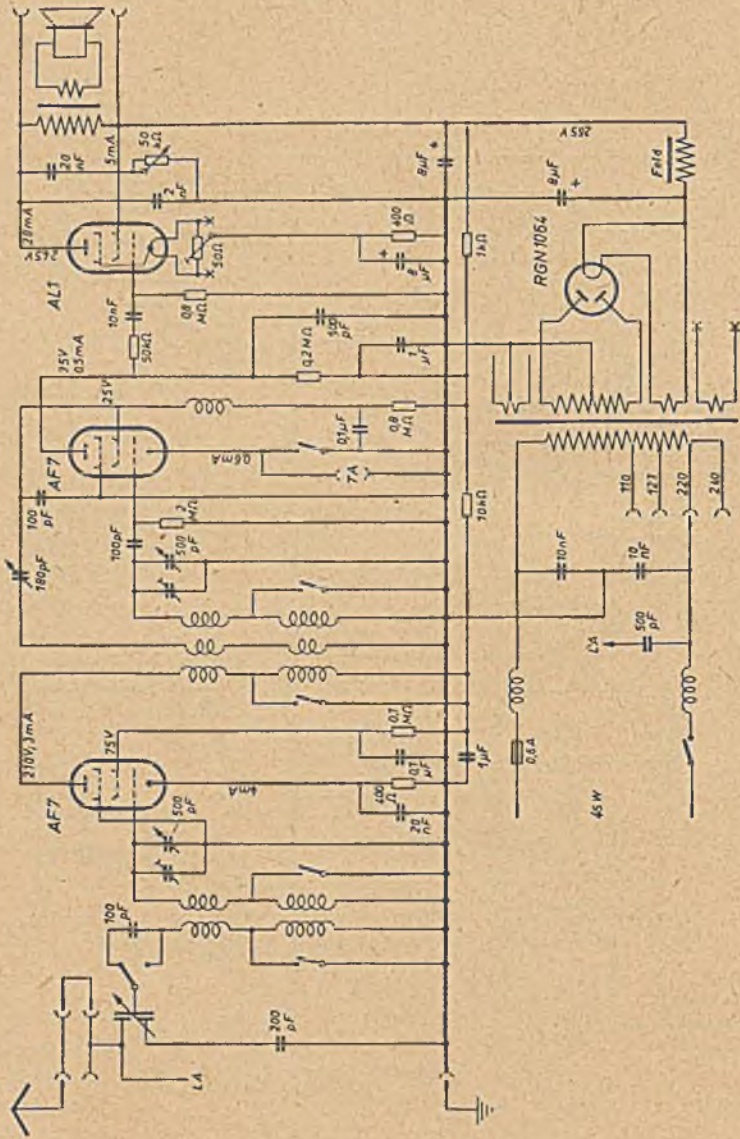

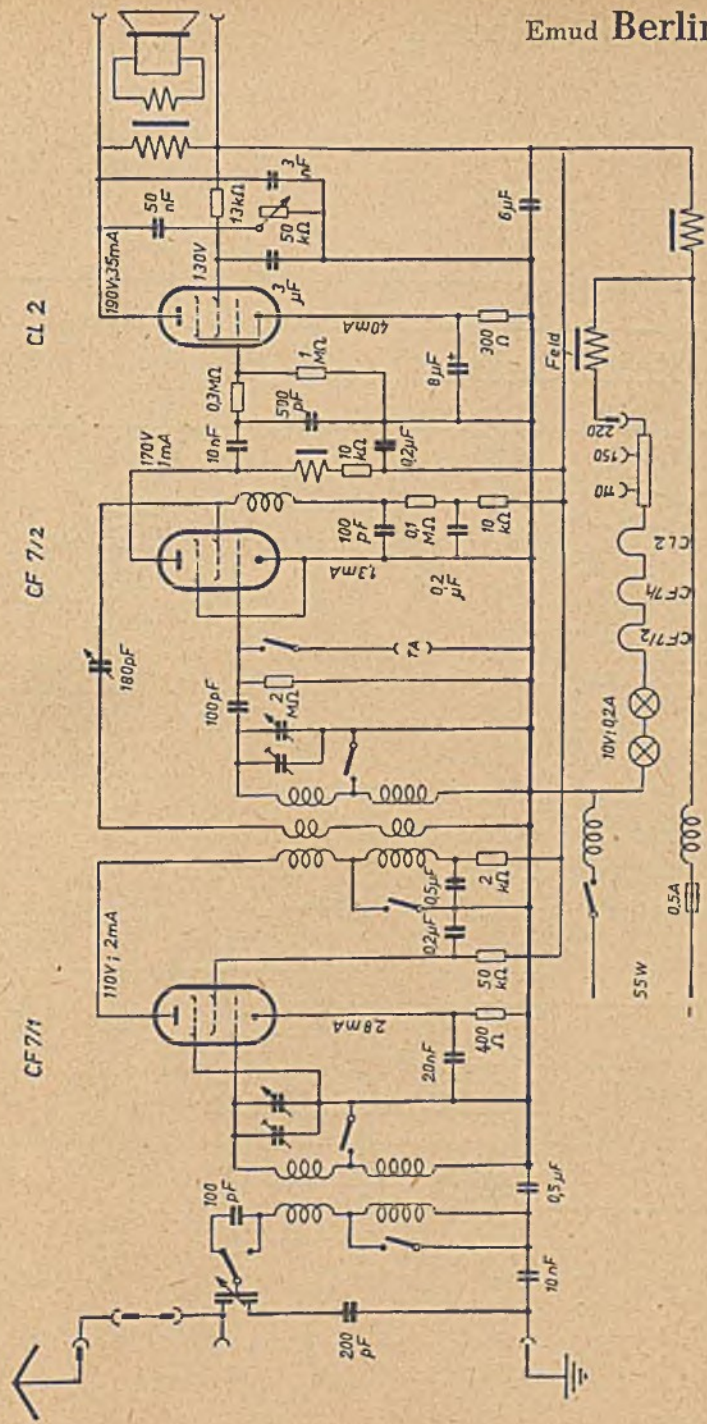

Emud 139 WK Record

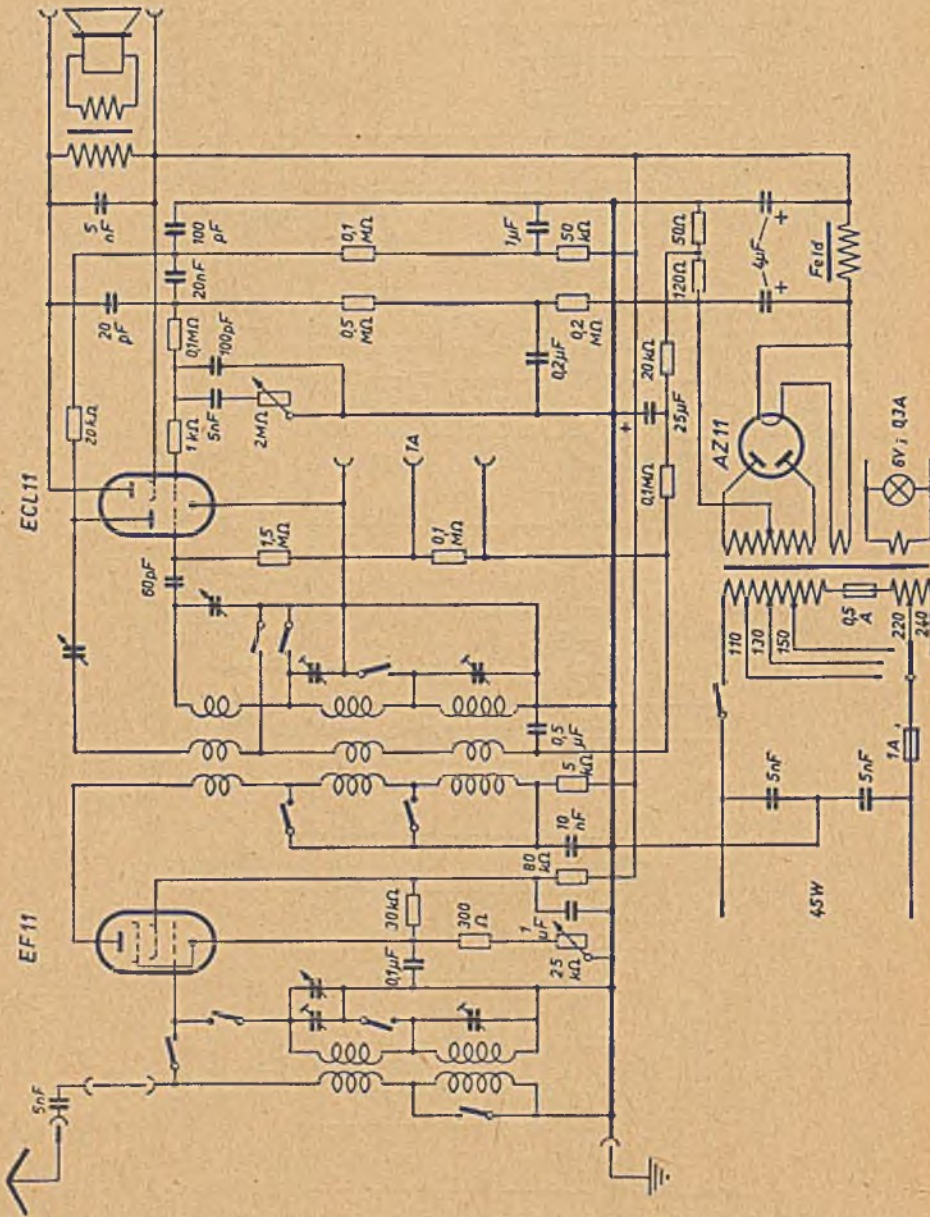

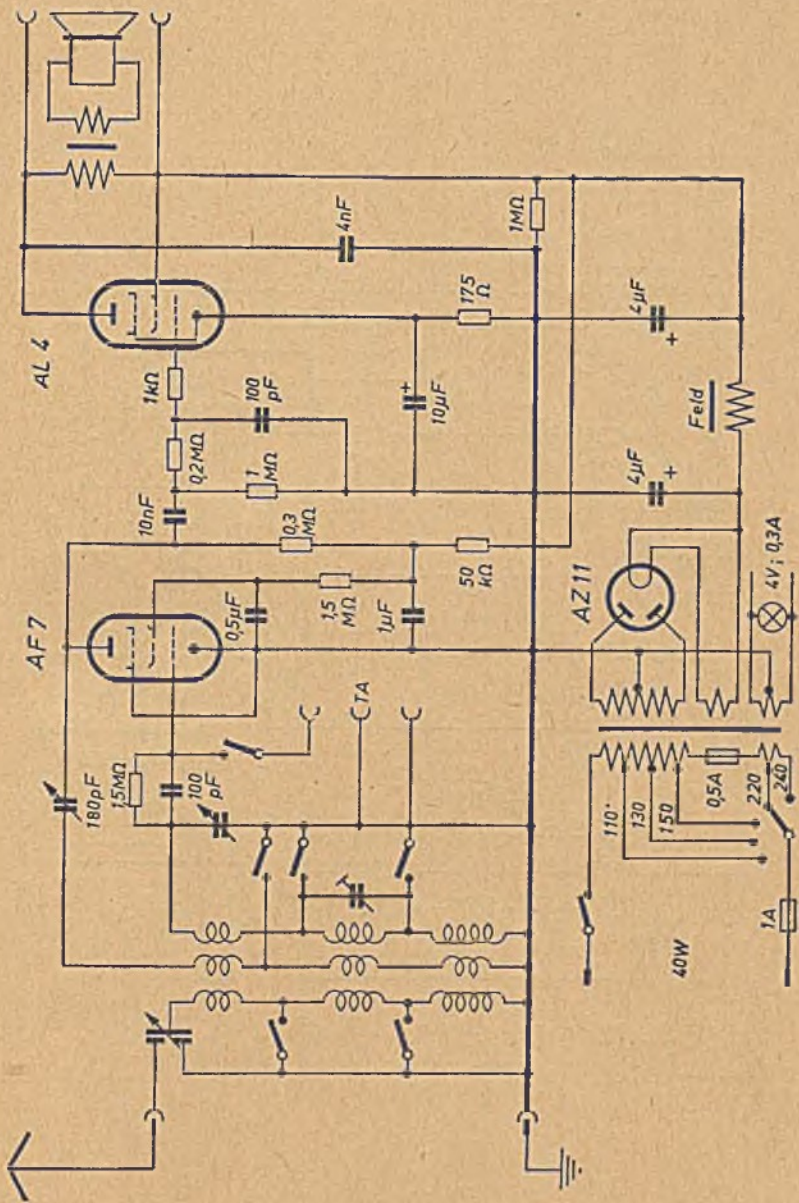

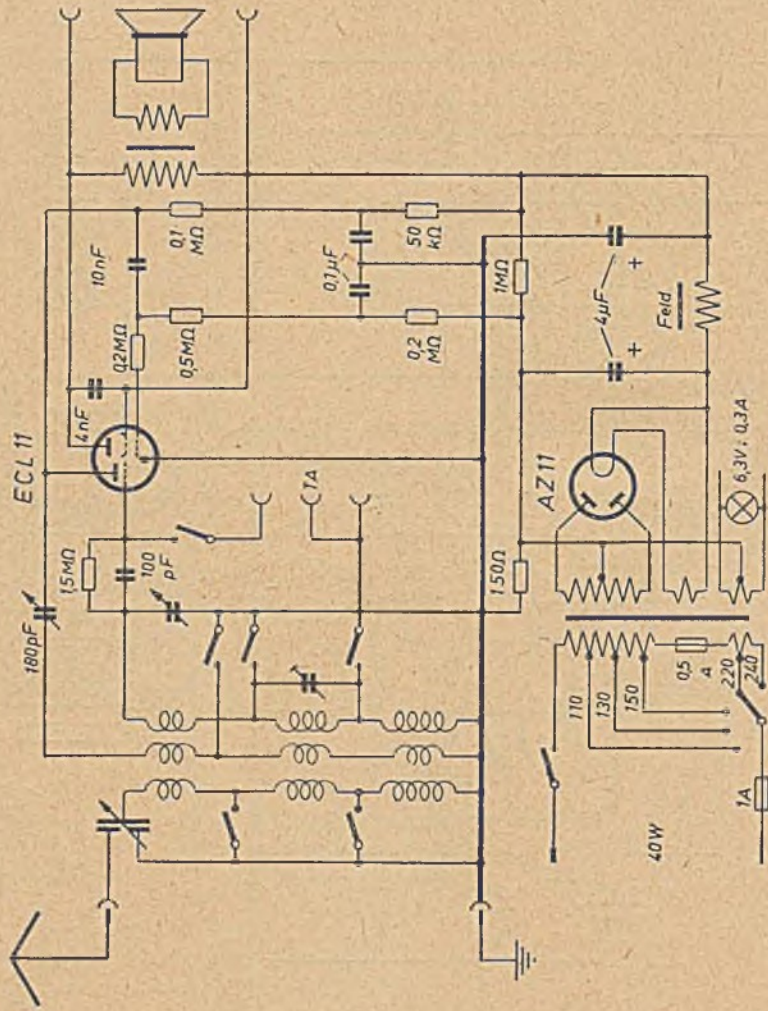

Emud E 47 W

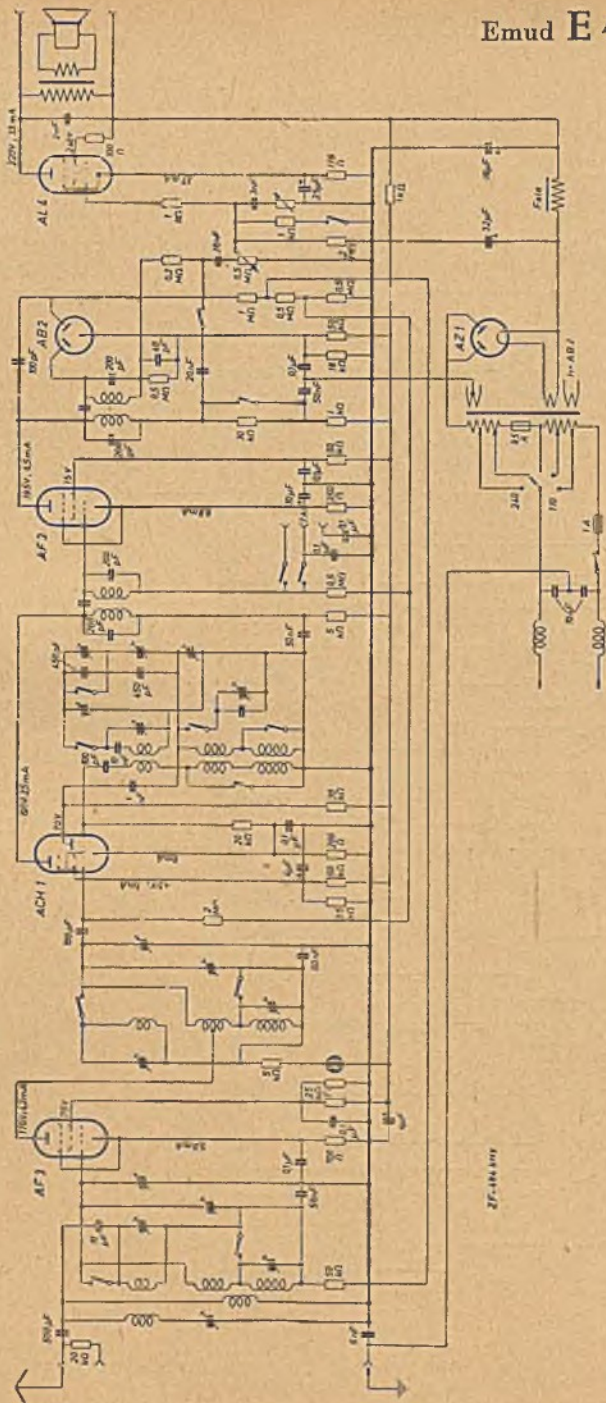

Emud 42 W Record

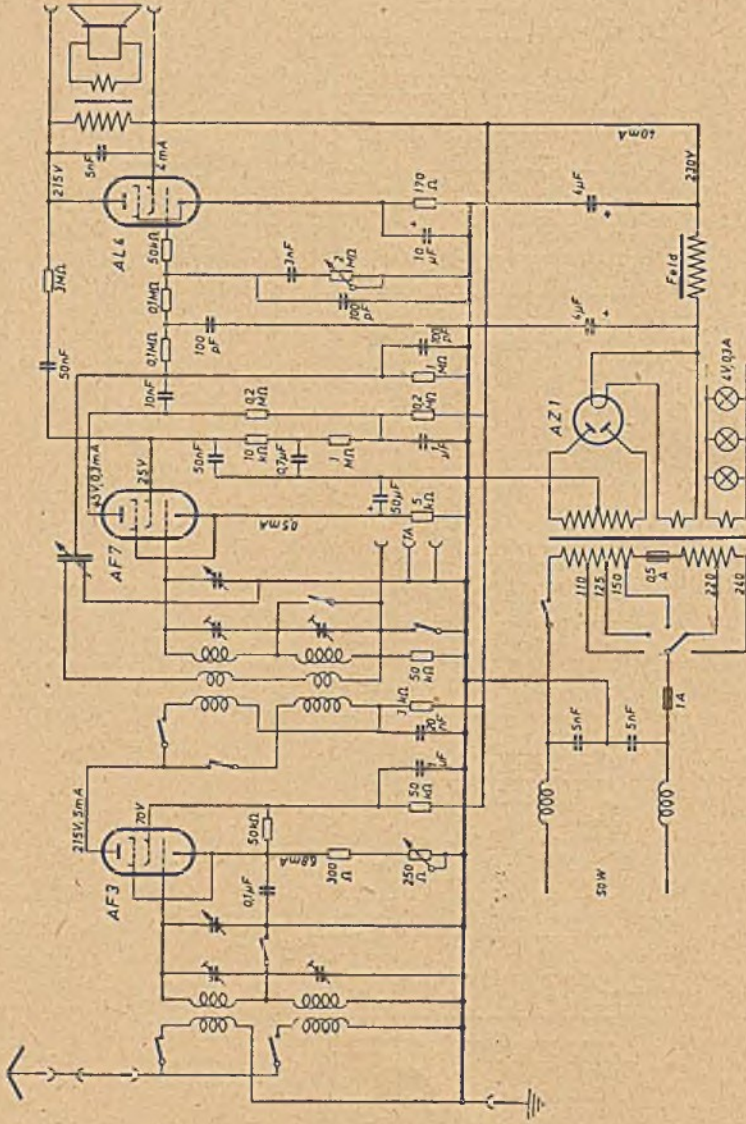

Emud 42 GW Record

POLITECHNIKA ŚLĄSKA
Katedra Elektroniki Przemysłowej

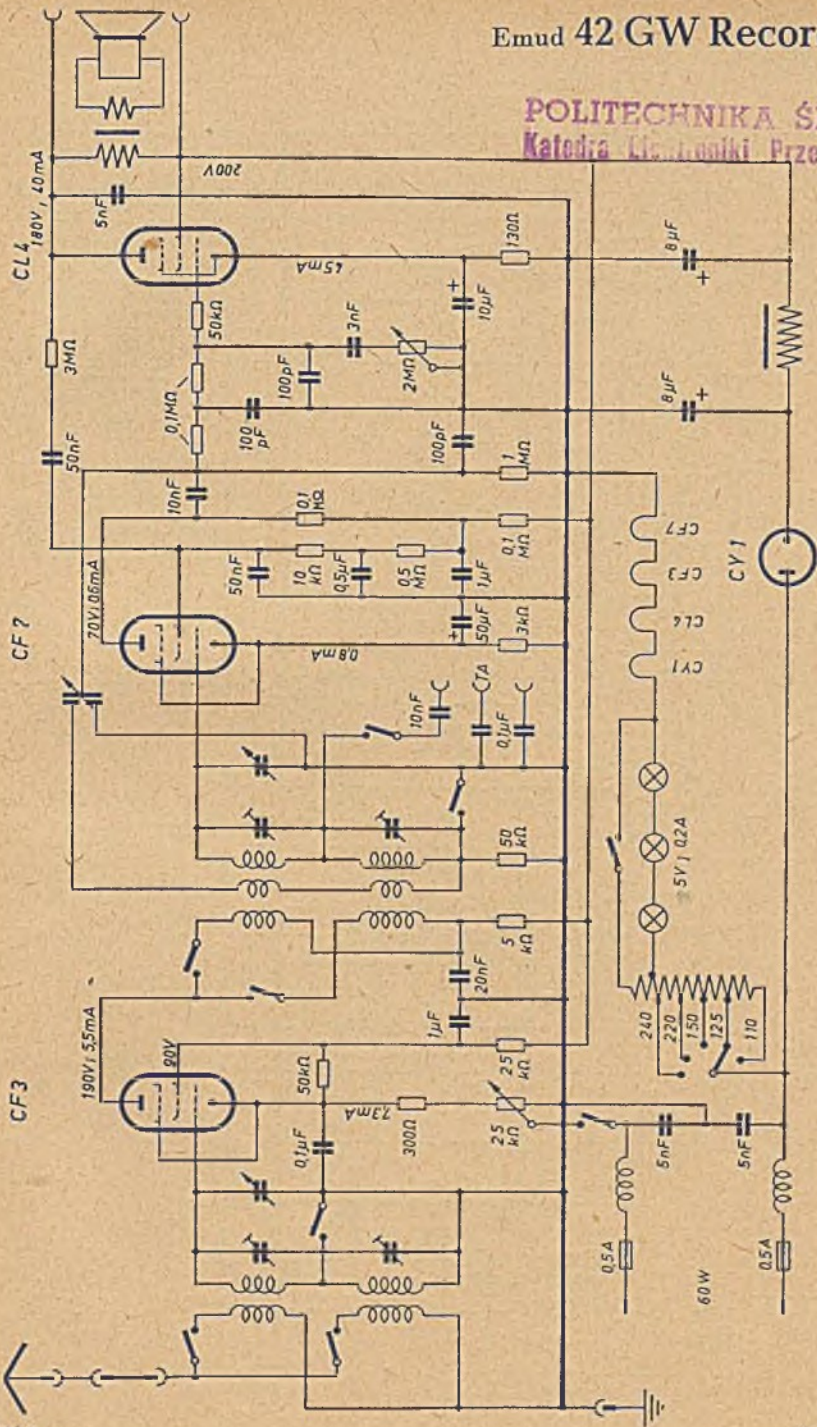

Emud
33 W

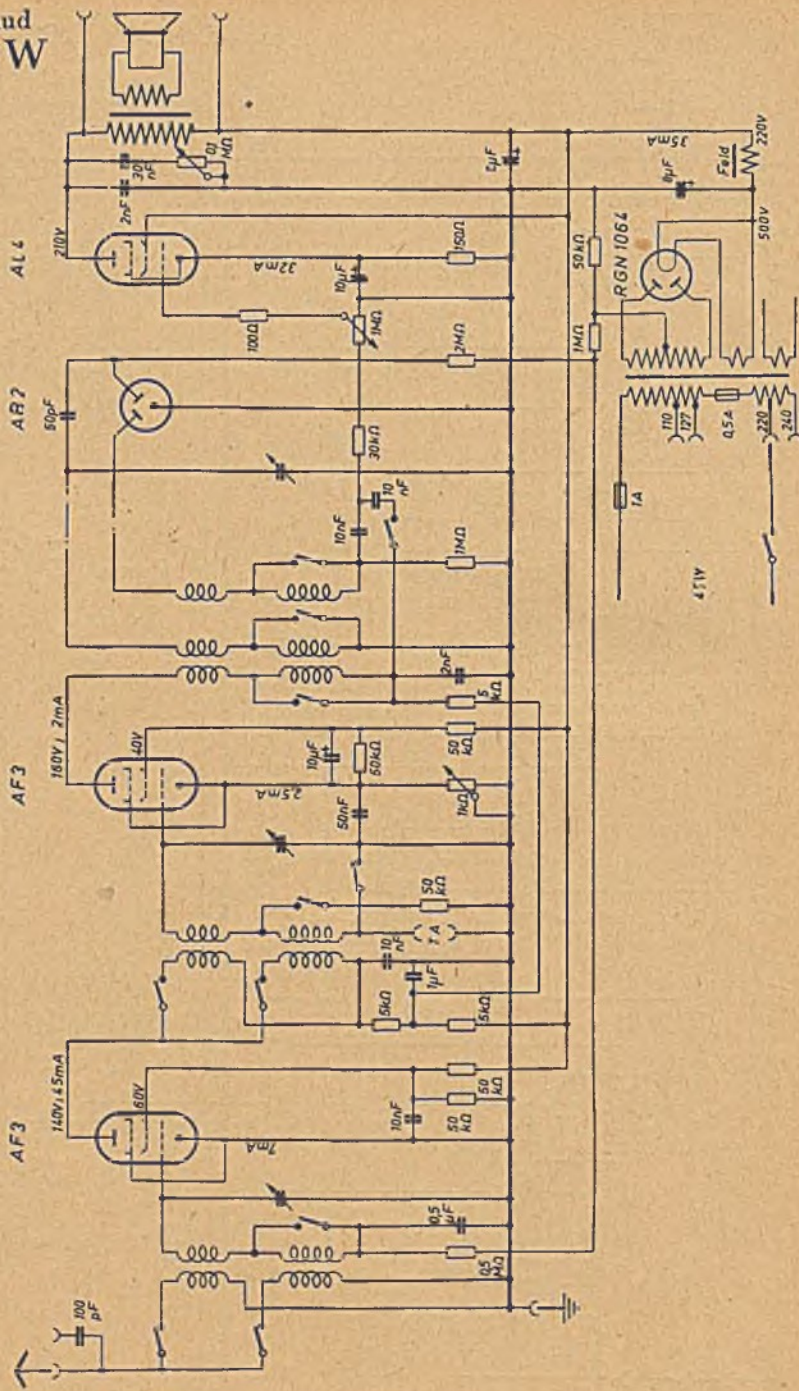

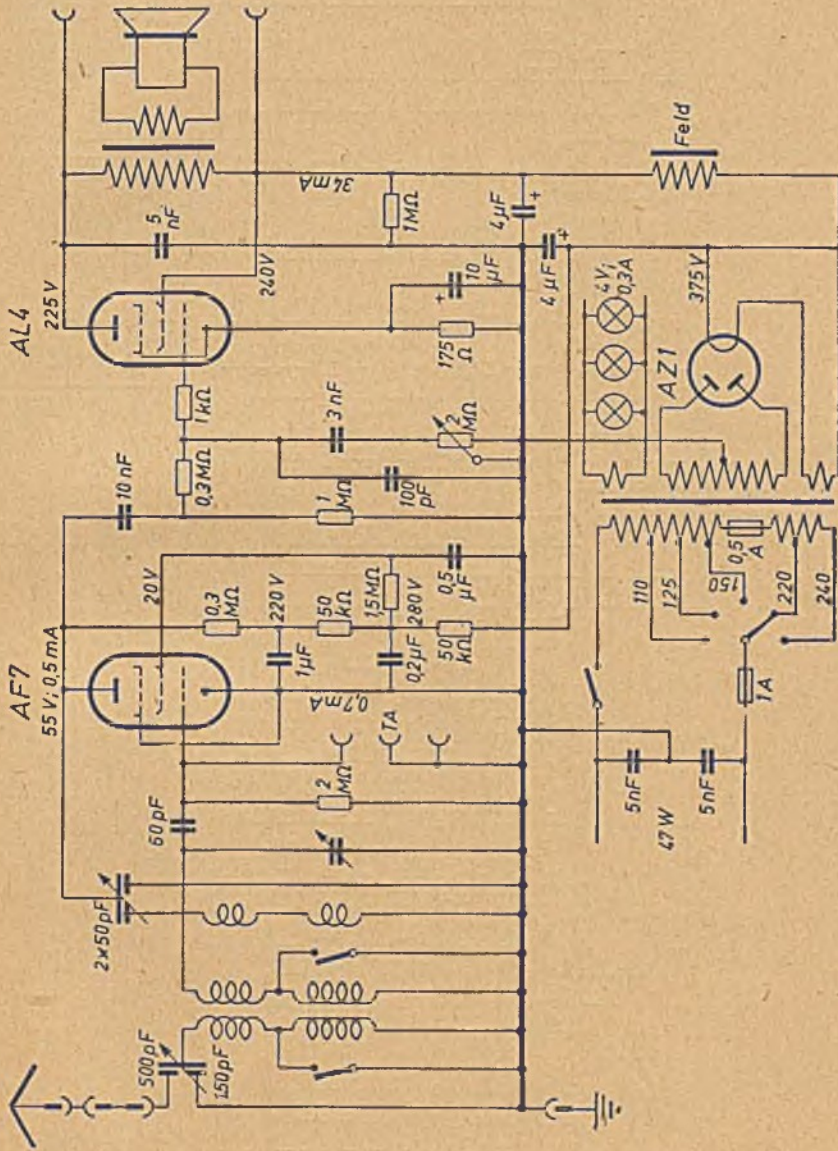

Emud
23 W

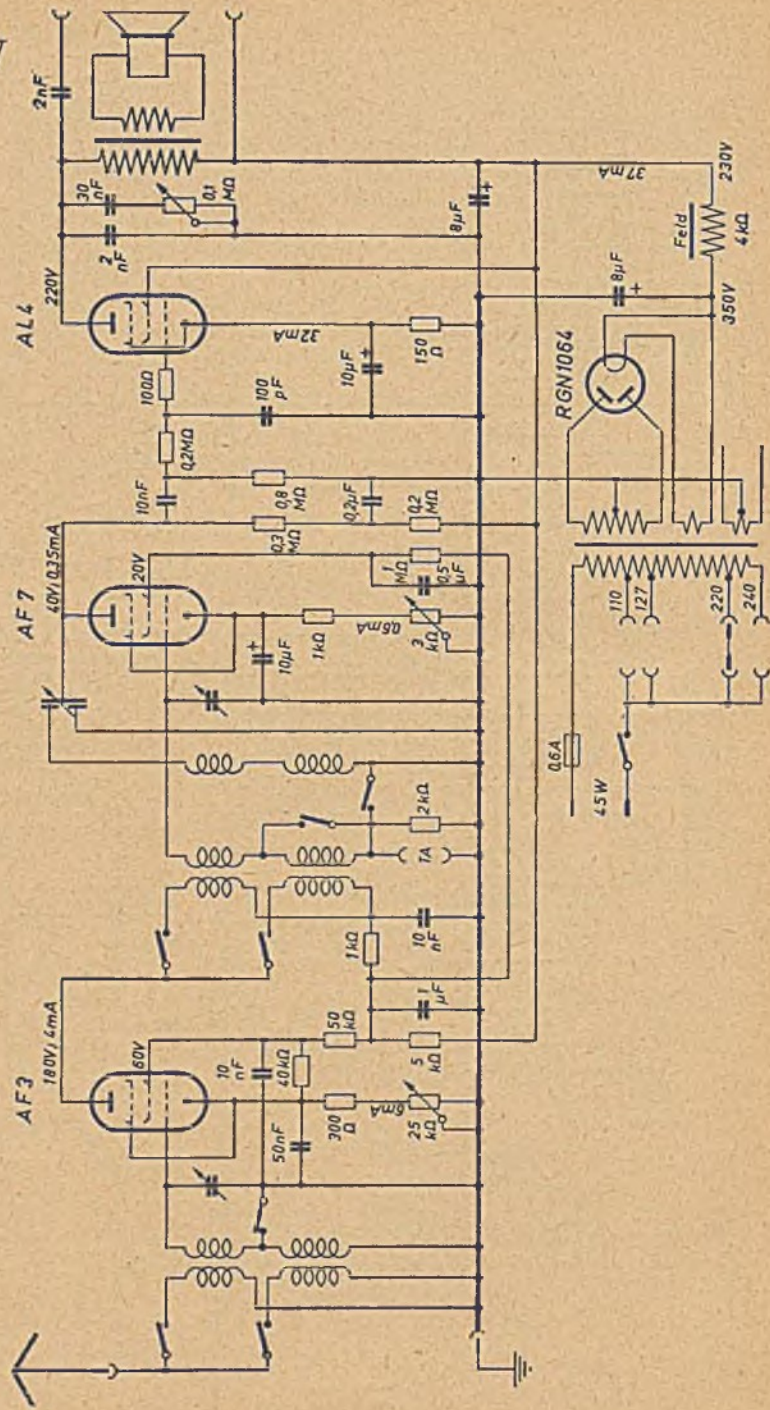

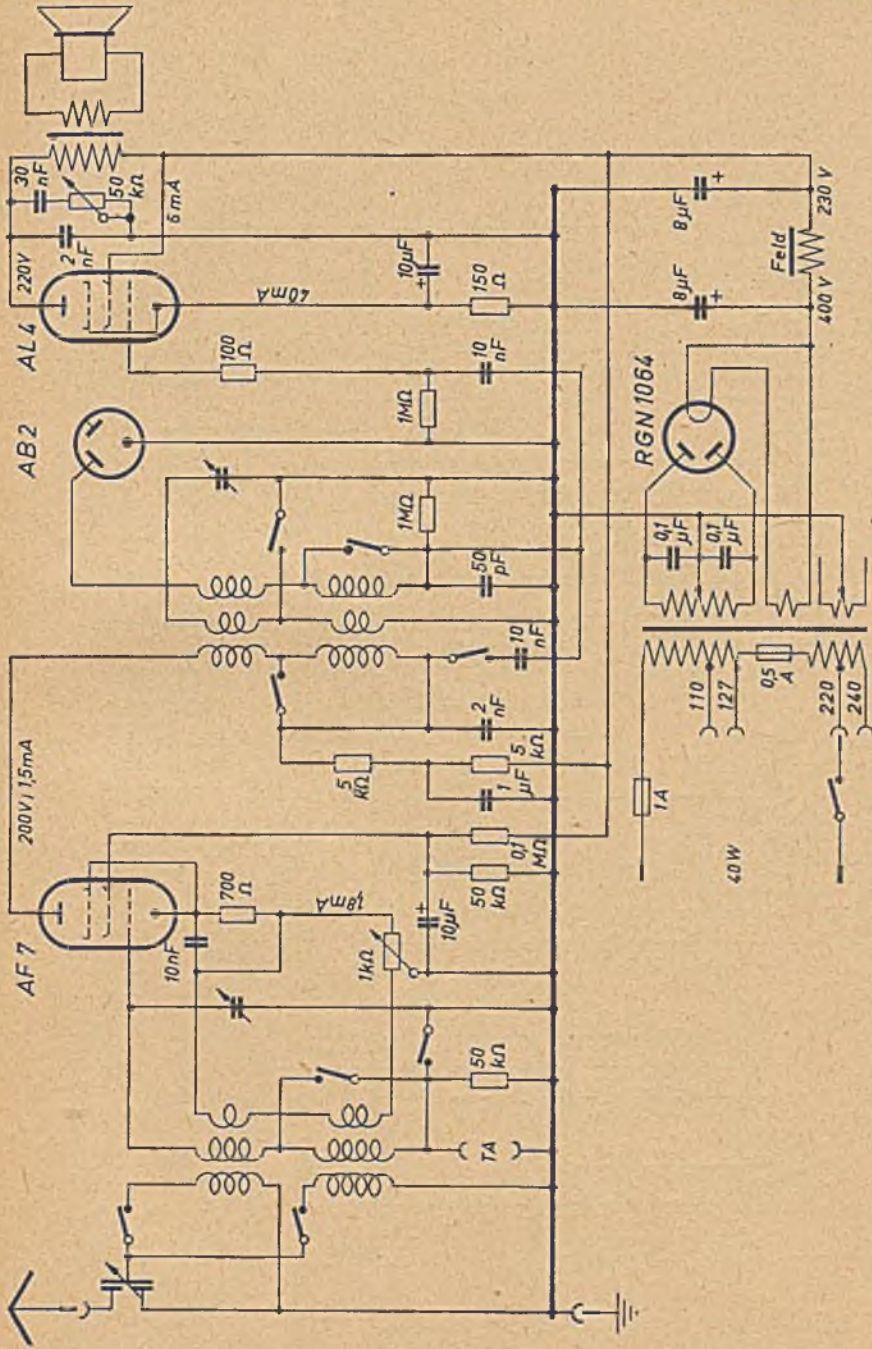

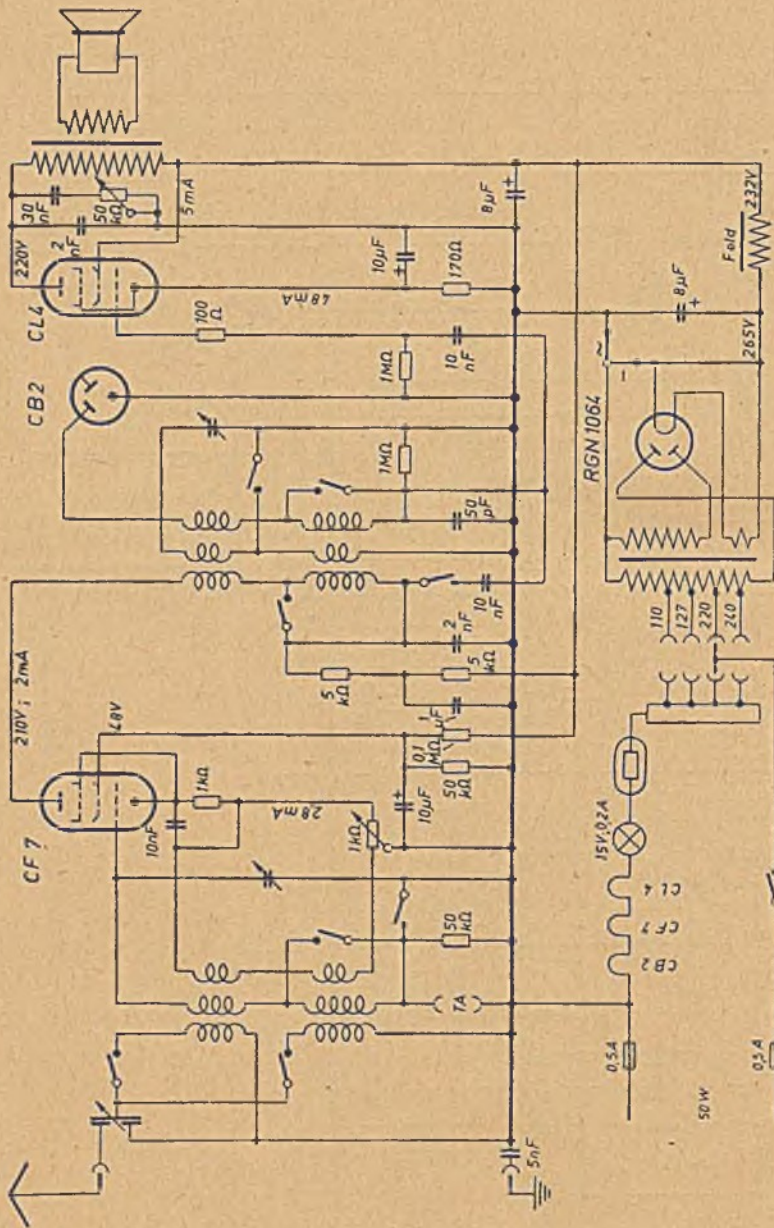

Emud B 4

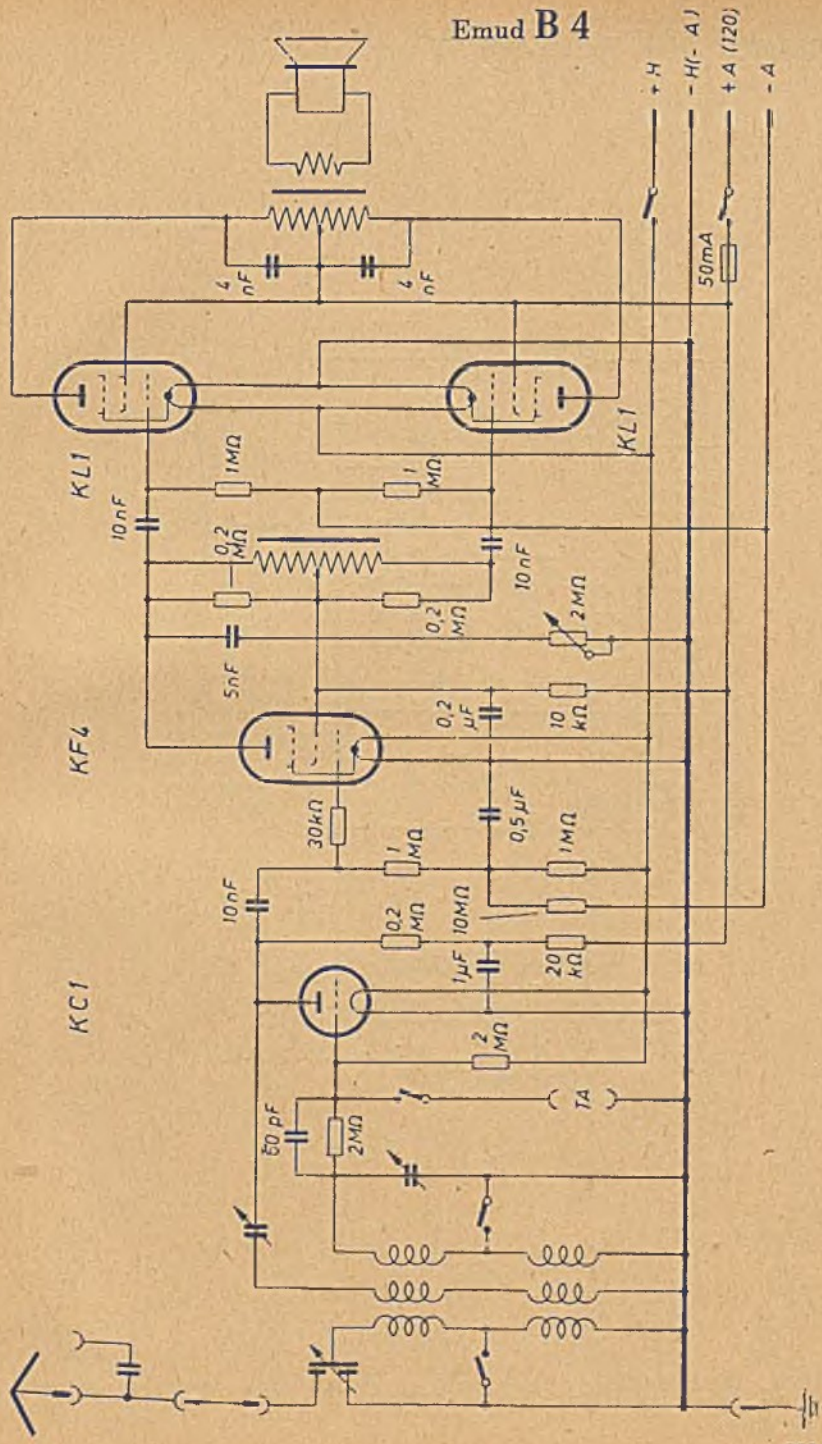

Emud L 2 W und 200 W

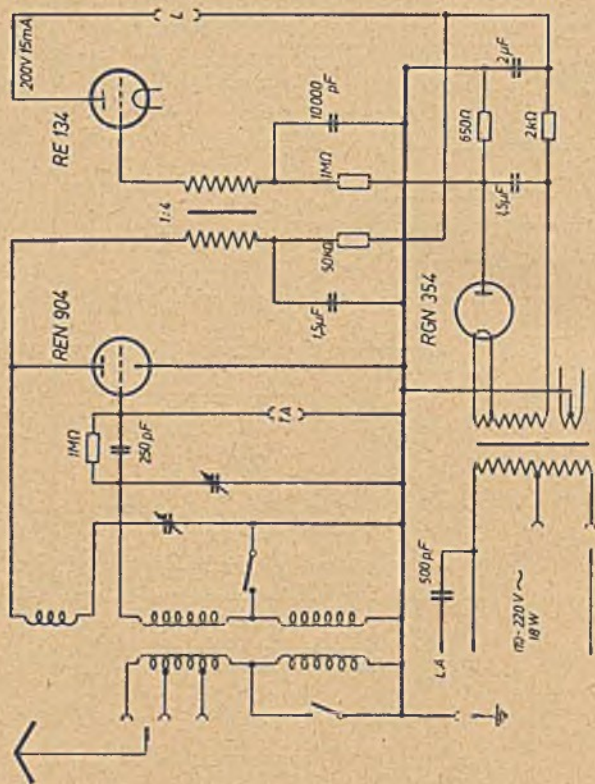

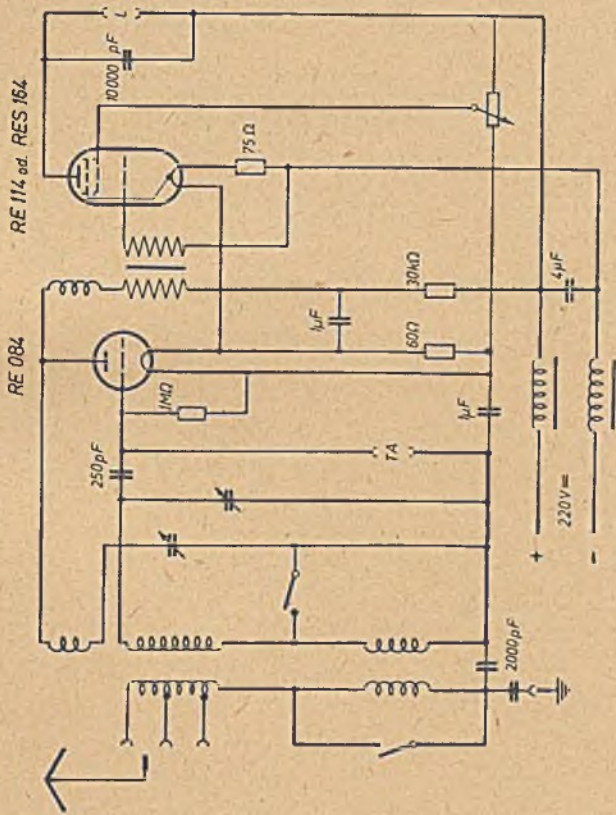

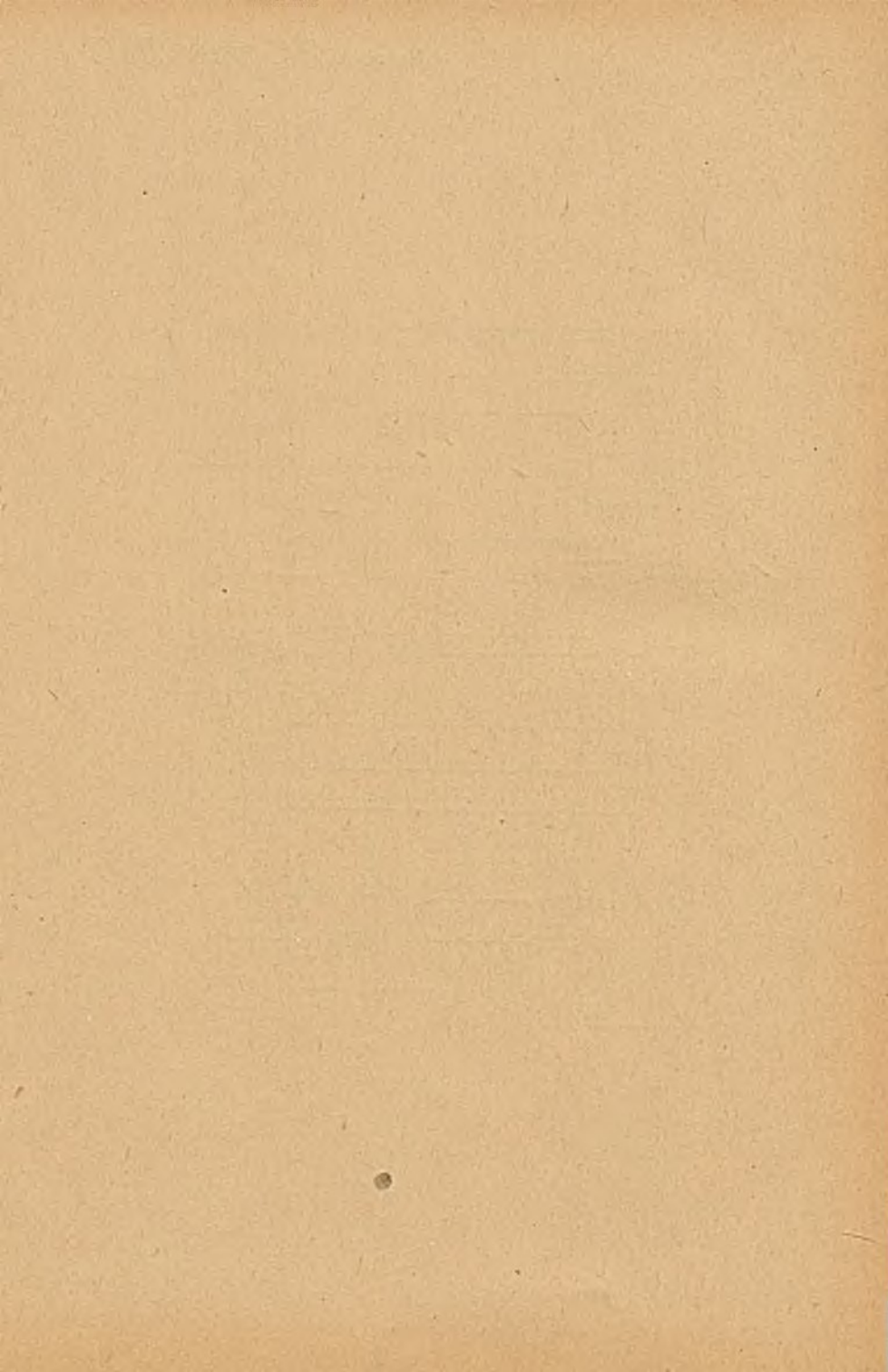

FUNKSTRAHL

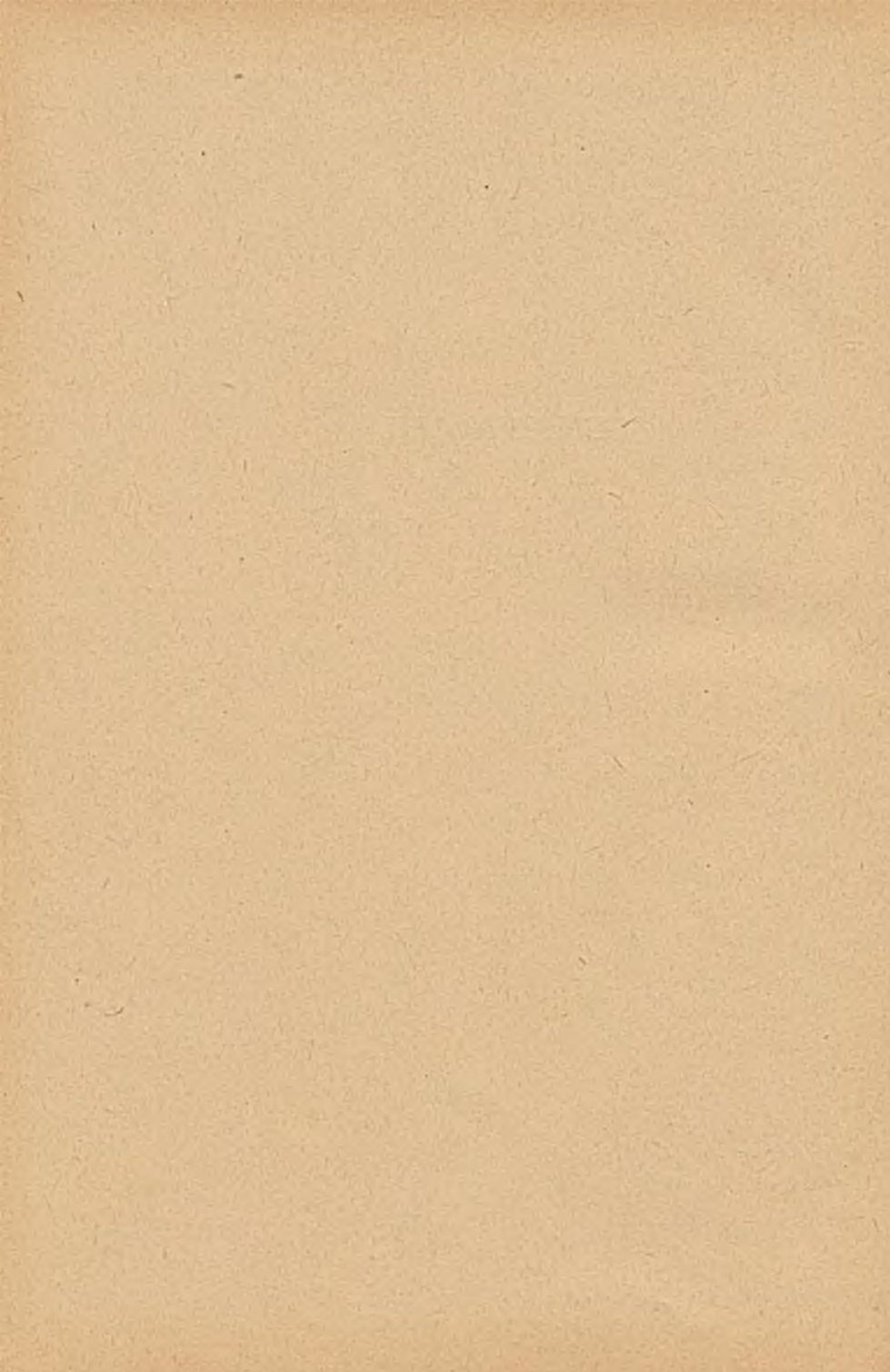

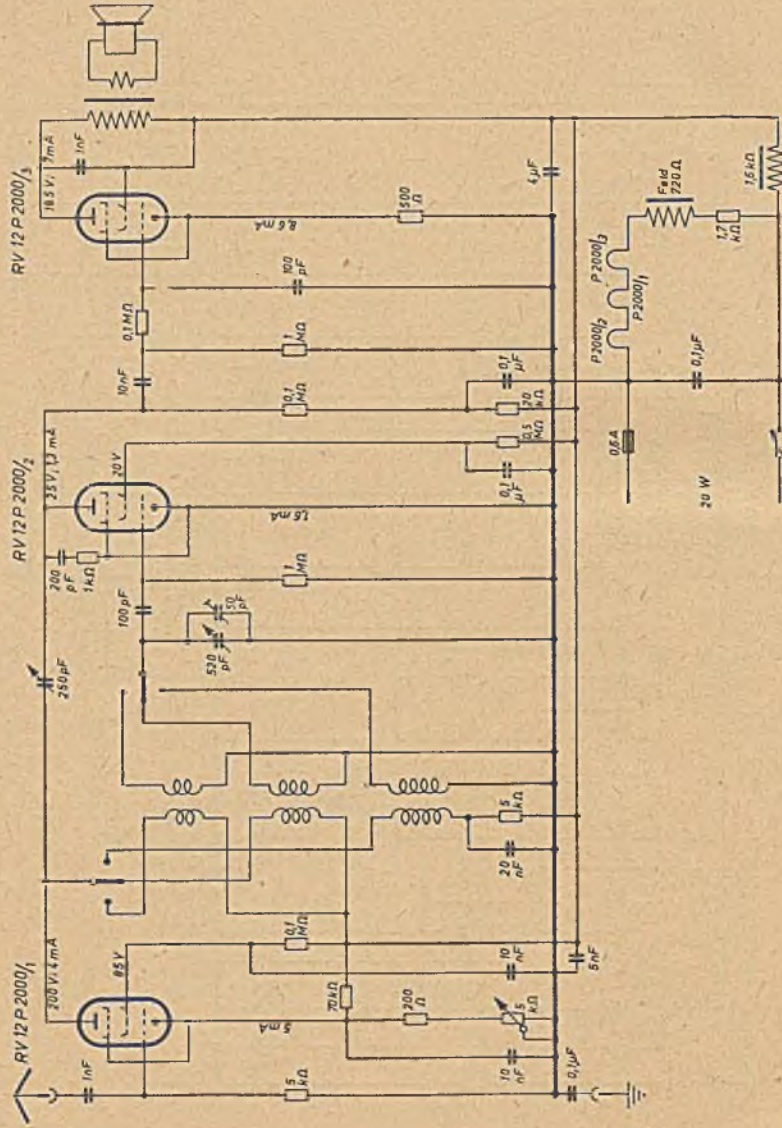

Folgende Firmen sind in der Schaltbildersammlung enthalten:

• AEG	Lange	Stern-Radio Berlin
• Äola	Lembeck	VEB (Phonetika)
• Akkord	Loewj/Opta	Stern-Radio Leipzig
• Atlas	Lorenz	VEB (Opta)
• Blaupunkt	LTP	Stern-Radio Rochlitz
• Blohm	Lumophon	VEB (Graetz)
• Brandt	Mende	Stern-Radio Staßfurt
• Braun	Meßgerätebau	VEB (Staßfurt)
• Continental	Metz	RFW
• DTW	MEW	Riweco
• Elbeg	Niemann	Rohde u. Schwarz
• Elbia	Nora	Ruwel
• Eleophon	Nord-Mende	Saba
• Elektro-Apparate-Fabrik	Opta-Spezial	Sachsenwerk
• Küppelsdorf	Owin	Schaleco
• Elektro-Apparate-Werke	Pellegaschetti	Schaub
• Treptow	Philips	Seibt
• Elmug	Radio-Union	Siemens
• Eltra	Reico	Star
• Emud	Rema	Staßfurt
• Funkstrahl		Staudigl
Gemeinschafts-Empfänger	<i>RFT:</i>	Südfunk
• Geta	Fernmeldewerk Arnstadt	TAK
• Graetz	VEB (Siemens)	Tefag
• Graßmann	Fernmeldewerk Treptow	Tefu
• Grundig	VEB (Graetz)	TEKADE
• Haco	Funkwerk Dresden	Telefunken
• Hagenok	VEB (Mende)	Tonfunk
• Huth	Funkwerk Källeda	Waldschmidt
• Jotha	VEB (Neutro-Werk)	Wandel und Goltermann
• Jungmann	Funkwerk Leipzig	Wega
• Klangfilm	VEB (Körting)	Willisen
• Körting	Funkwerk Zittau-Olbers-	Wobbe
• Krefft	dorf VEB (Seibt)	

Firmen in Österreich:

Eumig	Kapsch	Radione
Hornophon	Krischker	Zehetner
Ingelen	Minorva	Zerdik

Die mit einem ■ versehenen Firmen sind in diesem Band enthalten

FACHBUCHVERLAG GMBH LEIPZIG



Im gleichen Verlag erscheint:

ABLEITUNGEN UND FORMELN DER FUNK- UND FERNMELDETECHNIK

Von Ing. Hans Werner Fricke

Band I

Mathematische Grundlagen

136 Seiten mit 46 Abbildungen · DIN C 5 · Hlw. DM 6,20

Aus dem Inhalt: Potenzen und Wurzeln · Proportionen · Lineare und quadratische Gleichungen · Logarithmus · Exponentialfunktion · Entwicklung einer logarithmischen Teilung · Arithmetische und geometrische Reihe · Bogen- und Gradmaß · Trigonometrie · Differentialrechnung · Integralrechnung · Imaginäre und komplexe Zahlen · Zeitkonstante

Band II

Elementare und symbolische Berechnung der Resonanzkreise

201 Seiten mit 103 Abbildungen · DIN C 5 · Hlw. DM 7,80

Aus dem Inhalt: Elementare Berechnung der Resonanzkreise · Symbolische Berechnung der Resonanzkreise, des Transformators und des Bandfilters · Mathematische Grundlagen zur rechnerischen Auswertung von Oszillogrammen · Mathematische Grundlagen der Nomogramme

Für Funk- und Fernmeldetechniker ist die Beherrschung der mathematischen Grundlagen ihres Berufes die unentbehrliche Voraussetzung dafür, daß sie exakte und zeitsparende neue Arbeitsmethoden entwickeln können.

In übersichtlicher Form vermittelt der erste Band die notwendigen Kenntnisse. Als Anhang sind die Tafeln der trigonometrischen Funktionen, der Hyperbel- und natürlichen Exponentialfunktionen sowie die Mantissen der Briggschen Logarithmen beigegeben.

Der zweite Band behandelt die physikalischen Grundlagen des Wechselstromkreises mathematisch und bringt aus dem Gebiet der Wechselstromlehre nur das, was für die Berechnung von Schaltelementen gebraucht wird.

Zu beziehen durch jede Buchhandlung

FACHBUCHVERLAG GMBH LEIPZIG

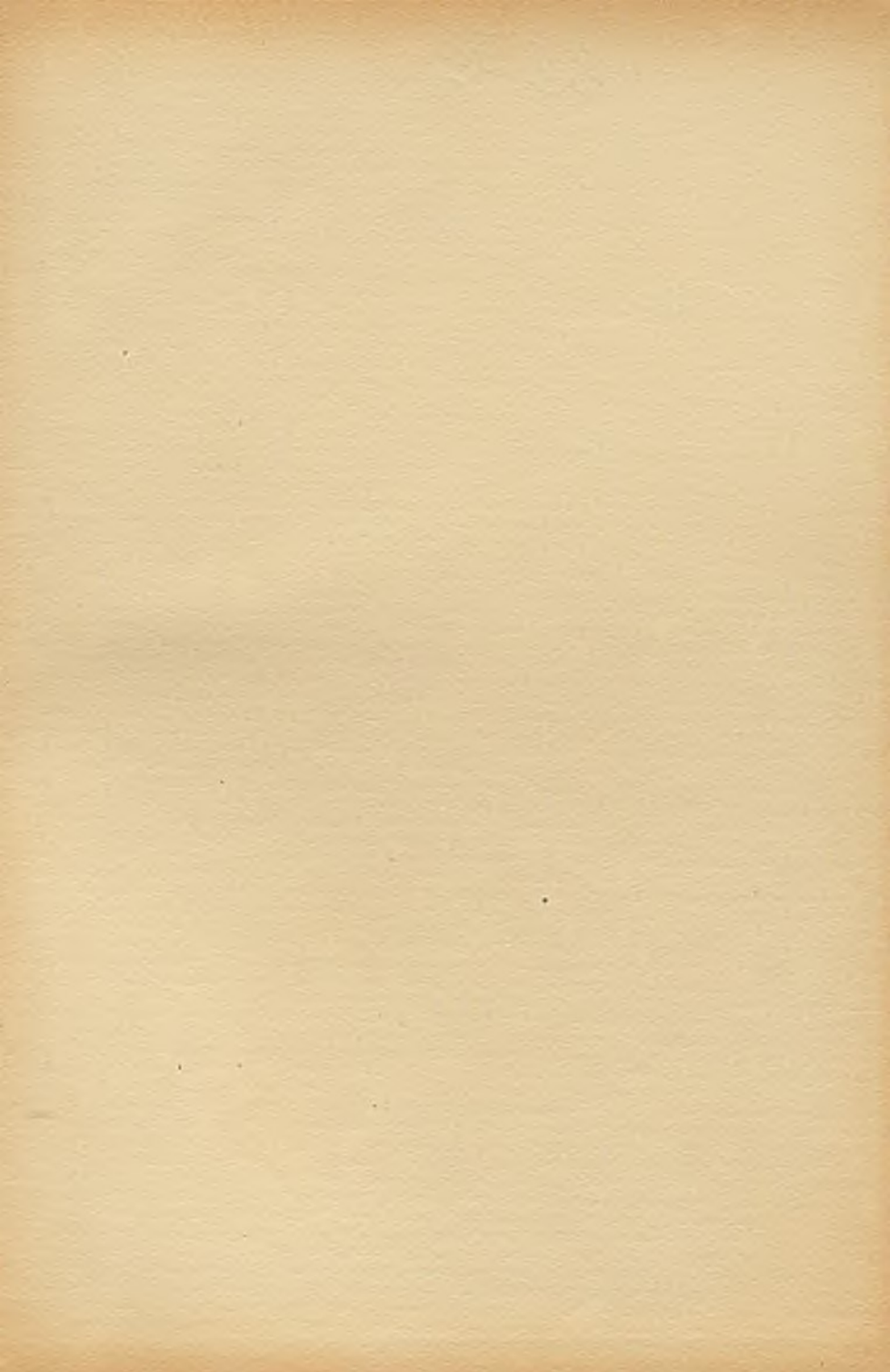

BG Politechniki Śląskiej
nr inw.: 102 - 126433



Dyr.1 126433